

# KITSAP COUNTY STORMWATER DESIGN MANUAL

Effective Date: April 1, 1997



Kitsap County Department of Public Works  
Stormwater Division  
614 Division Street, MS-26  
Port Orchard, WA 98366  
360-876-7121



# TABLE OF CONTENTS

## CHAPTER 1 - INTRODUCTION

1.1	CHANGING CIRCUMSTANCES	1-1
1.2	ADDITIONAL REFERENCES	1-1
1.3	PENALTIES AND ENFORCEMENT	1-2
1.4	EXISTING HAZARDS	1-3
1.5	ENGINEER'S RESPONSIBILITIES	1-3
1.5.1	PROJECT ENGINEER'S RESPONSIBILITIES	1-3
1.5.2	SOILS ENGINEER'S RESPONSIBILITIES	1-4
1.5.3	GEOTECHNICAL ENGINEER'S RESPONSIBILITIES	1-5
1.6	TRANSFER OF ENGINEERING RESPONSIBILITY	1-5
1.7	COUNTY STAFF ASSISTANCE	1-5

## CHAPTER 2 - SUBMITTAL REQUIREMENTS

2.1	INTRODUCTION	2-1
2.1.1	LARGE LOT SUBDIVISIONS	2-1
2.2	LAND USE PERMITS - PRELIMINARY	2-1
2.2.1	PRELIMINARY DRAINAGE REVIEW	2-2
	PRELIMINARY DRAINAGE PLAN - CONTENTS	2-2
	PRELIMINARY DRAINAGE REPORT	2-4
2.3	SITE DEVELOPMENT ACTIVITY PERMIT	2-5
2.3.1	WHEN PERMIT REQUIRED	2-5
2.3.2	APPLICATION PROCESS	2-5
2.3.3	APPLICATION SUBMITTAL DOCUMENTS MINIMUM REQUIREMENTS	2-7
	ABBREVIATED PLAN	2-7
	EROSION AND SEDIMENTATION CONTROL PLAN	2-9
	ENGINEERED GRADING PLAN	2-10
	ENGINEERED DRAINAGE PLANS	2-11
	DRAINAGE REPORT	2-15
	DOWNSTREAM ANALYSIS	2-18

2.4	COVENANTS, SURETIES AND LIABILITY INSURANCE	2-20
2.4.1	SITE STABILIZATION	2-20
2.4.2	PERFORMANCE COVENANT FOR SITE STABILIZATION	2-20
2.4.3	PERFORMANCE SURETY FOR SITE STABILIZATION	2-21
2.4.4	PERFORMANCE BOND FOR UNCOMPLETED SITE IMPROVEMENTS	2-21
2.4.5	COMMERCIAL LIABILITY INSURANCE	2-22
2.4.6	MAINTENANCE BONDS	2-22
2.5	PRECONSTRUCTION MEETING	2-22
2.6	FINAL PROJECT APPROVAL	2-23
2.7	PROJECT PHASING	2-25

**APPENDIX 2A - KITSAP COUNTY STANDARD PLAN NOTES**

**CHAPTER 3 - EROSION AND SEDIMENTATION CONTROL**

3.1	OVERVIEW	3-1
3.1.1	EROSION AND SEDIMENTATION	3-1
	EROSION	3-1
	SEDIMENTATION	3-2
	IMPACTS OF EROSION AND SEDIMENTATION	3-2
3.2	MINIMUM REQUIREMENTS	3-3
3.2.1	PERFORMANCE	3-3
3.2.2	DESIGN STORM	3-4
3.2.3	MINOR DEVELOPMENTS	3-4
3.2.4	MAJOR DEVELOPMENTS	3-5
3.2.5	EROSION AND SEDIMENTATION CONTROL PLAN	3-8

**APPENDIX 3A - ESC BEST MANAGEMENT PRACTICES REFERENCE GUIDE**

**APPENDIX 3B - ESC BEST MANAGEMENT PRACTICES**

## **CHAPTER 4 - GRADING**

4.1	INTRODUCTION	4-1
4.2	APPLICABILITY	4-1
	4.2.1 PERMIT EXEMPTIONS	4-2
	4.2.2 ENGINEERED GRADING	4-3
4.3	SEPA REQUIREMENTS	4-3
4.4	REVIEW COORDINATION	4-4
4.5	FEES	4-5
4.6	PERMIT REQUIREMENTS	4-5
	4.6.1 CONSTRUCTION LIMITS	4-5
	4.6.2 CHANGED CONDITIONS, STOP WORK ORDER AND PERMIT REVOCATION	4-5
	4.6.3 ENGINEERS' NOTIFICATION OF NONCOMPLIANCE	4-6
	4.6.4 PERMIT TIME LIMIT	4-6
	4.6.5 INSPECTIONS	4-6
	4.6.6 COMPLETION OF WORK AND FINAL APPROVAL	4-6
4.7	GRADING STANDARDS	4-7
	4.7.1 SOILS ENGINEERING INVESTIGATION REPORT	4-7
	4.7.2 GEOTECHNICAL ENGINEERING INVESTIGATION REPORT	4-7
	4.7.3 EXCAVATIONS	4-8
	GENERAL	4-8
	SLOPE STEEPNESS	4-8
	4.7.4 FILLS AND EMBANKMENTS	4-8
	GENERAL	4-8
	PREPARATION OF GROUND	4-8
	FILL MATERIAL	4-8
	COMPACTION	4-9
	SLOPE	4-9
	STRUCTURES	4-9
	4.7.5 SETBACKS	4-10
	GENERAL	4-10
	TOP OF CUT SLOPES	4-10
	TOE OF FILL SLOPES	4-10
	MODIFICATION OF SLOPE LOCATION	4-10

4.7.6	DRAINAGE AND TERRACING	4-11
	GENERAL	4-11
	TERRACE	4-11
	SUBSURFACE DRAINAGE	4-11
	DISPOSAL	4-11
	INTERCEPTOR DRAINS	4-11
4.7.7	IMPERVIOUS SURFACES	4-12
4.7.8	EROSION CONTROL	4-12
	APPLICANT'S RESPONSIBILITY	4-12
	EMERGENCY CONTACT PERSON	4-12
	SEALING THE SURFACE	4-13
	REVEGETATION	4-13
	<u>NOTICE OF GRADING OR FILLING</u>	4-14

## **CHAPTER 5 - STORMWATER QUANTITY CONTROL FACILITIES**

5.1	GENERAL REQUIREMENTS	5-1
5.1.1	PURPOSE AND SCOPE	5-1
5.1.2	RUNOFF CONTROL	5-1
	PEAK RATE CONTROL	5-1
	STREAMBANK EROSION CONTROL	5-1
	VOLUME CONTROL	5-2
5.1.3	CLOSED DEPRESSIONS	5-2
	MINIMUM REQUIREMENTS	5-2
5.1.4	EXEMPTIONS FROM RUNOFF CONTROL REQUIREMENTS	5-3
5.2	HYDROLOGY AND DESIGN STRATEGIES	5-4
5.2.1	COMPUTATION METHODS	5-4
	HYDROGRAPH ANALYSIS	5-4
	LEVEL-POOL ROUTING	5-5
5.2.2	BASIC RUNOFF PARAMETERS	5-5
	PRECIPITATION	5-5
	CURVE NUMBERS	5-13
	TIME OF CONCENTRATION	5-16
5.2.3	DESIGN STRATEGIES	5-18
	DRAINAGE BASIN DELINEATION	5-19
	OFF-SITE CONTRIBUTING RUNOFF	5-19
	BYPASS AREAS	5-19
	CORRECTION FACTORS	5-20

5.3	FACILITY DESIGN REQUIREMENTS	5-20
5.3.1	PONDS	5-20
	SITE CONSTRAINTS	5-22
	POND GEOMETRICS	5-22
	SETBACKS	5-25
	OVERFLOW	5-25
	FENCING	5-27
	SIGNING	5-27
	BERM EMBANKMENT/SLOPE STABILIZATION	5-30
	ACCESS	5-30
5.3.2	PARKING LOT PONDS	5-32
5.3.3	DETENTION TANKS AND VAULTS	5-34
	GENERAL DESIGN CRITERIA	5-37
	MATERIALS & STRUCTURAL STABILITY	5-37
	ACCESS	5-38
5.3.4	CONTROL STRUCTURES	5-41
	CONTROL STRUCTURE DESIGN CRITERIA	5-41
	RECTANGULAR NOTCHED, SHARP CRESTED WEIR	5-45
	V-NOTCH, SHARP CRESTED WEIR	5-45
5.3.5	RETENTION FACILITIES	5-46
	SOILS IDENTIFICATION AND DETERMINATION OF	
	INFILTRATION RATE	5-46
	DESIGN CRITERIA FOR INFILTRATION TRENCHES	
	AND PONDS	5-47
	RETENTION PONDS	5-48
	INFILTRATION TRENCHES	5-48
5.3.6	INDIVIDUAL DOWNSPOUT INFILTRATION SYSTEMS	5-49

## **CHAPTER 6 - STORMWATER QUALITY CONTROL FACILITIES**

6.1	KNOWN POLLUTANTS IN STORMWATER	6-1
6.2	WATER QUALITY DESIGN STORM	6-3
6.3	BIOFILTRATION BMPs	6-3
	6.3.1 SWALE DESIGN CRITERIA	6-3
	6.3.2 FILTER STRIP DESIGN CRITERIA	6-5
6.4	WET PONDS AND WET VAULTS/TANKS	6-5
	6.4.1 WET POND DESIGN	6-6
	SIZING WET PONDS	6-6
	POND CONFIGURATION AND GEOMETRY	6-6

	ACCESS	6-7
	SITE CONSTRAINTS	6-7
	DAM SAFETY	6-7
6.4.2	WET VAULT AND WET TANK DESIGN	6-8
	LIMITATION	6-8
	PURPOSE AND DEFINITION	6-8
	SIZING CRITERIA	6-8
	GEOMETRICS	6-8
	MATERIALS AND STRUCTURAL STABILITY	6-8
	ACCESS	6-9
6.5	OIL/WATER SEPARATORS	6-9

## **CHAPTER 7 - COLLECTION AND CONVEYANCE FACILITIES**

7.1	PURPOSE AND SCOPE	7-1
7.2	GENERAL DESIGN CRITERIA	7-1
	7.2.1 ROUTE DESIGN	7-1
	7.2.2 EASEMENTS AND SETBACKS	7-2
	7.2.3 MAINTENANCE ACCESS	7-2
	7.2.4 DATUM	7-3
7.3	DETERMINATION OF DESIGN FLOW	7-3
	7.3.1 DESIGN EVENT	7-3
	7.3.2 DESIGN METHODOLOGY	7-3
	7.3.3 RATIONAL METHOD	7-3
7.4	CAPACITY ANALYSIS	7-8
7.5	DESIGN CRITERIA FOR OPEN CHANNELS	7-9
	7.5.1 GEOMETRY	7-9
	7.5.2 FREEBOARD	7-9
	7.5.3 CHANNEL LINING	7-9
	7.5.4 CHECK DAMS	7-13
	7.5.5 CHANNEL LOCATION	7-13
	7.5.6 BIOFILTRATION SWALES	7-13
7.6	DESIGN CRITERIA FOR CULVERTS	7-13
	7.6.1 ACCEPTABLE PIPE MATERIAL	7-13
	7.6.2 HEADWALLS	7-15
	7.6.3 GENERAL CULVERT DESIGN CRITERIA	7-15



7.7	DESIGN CRITERIA FOR PIPE SYSTEMS	7-17
7.7.1	ACCEPTABLE PIPE MATERIAL	7-17
7.7.2	PIPE ALIGNMENT	7-17
7.7.3	CONNECTIONS TO PIPE SYSTEMS	7-17
7.7.4	VERTICAL ALIGNMENT OF PIPES AT STRUCTURES	7-17
7.7.5	DOWNSIZING OF PIPES	7-18
7.7.6	GENERAL PIPE CRITERIA	7-18
7.7.7	STEEP SLOPE INSTALLATION	7-19
7.7.8	PRIVATE SECONDARY DRAINAGE SYSTEMS	7-19
7.8	DESIGN CRITERIA FOR INLET STRUCTURES	7-19
7.9	DESIGN CRITERIA FOR OUTFALLS	7-21
7.10	STORMWATER PUMPS	7-21
7.11	BRIDGES	7-22

## **CHAPTER 8 - OPERATION AND MAINTENANCE**

8.1	OPERATION AND MAINTENANCE MANUAL	8-1
8.2	OPERATION AND MAINTENANCE REQUIREMENTS	8-3
8.2.1	RESPONSIBILITY FOR MAINTENANCE	8-3
8.2.2	MAINTENANCE FREQUENCY	8-3
8.2.3	DISPOSAL OF WASTE FROM MAINTENANCE ACTIVITIES	8-3
8.2.4	CONTROL STRUCTURES AND CATCH BASINS	8-4
8.2.5	INFILTRATION BASINS	8-4
8.2.6	INFILTRATION TRENCHES AND ROOF DOWNSPOUT INFILTRATION TRENCHES	8-5
8.2.7	CONCRETE GRID AND MODULAR PAVEMENT	8-5
8.2.8	DETENTION PONDS, VAULTS AND TANKS	8-5
	GENERAL	8-5
	VEGETATION	8-5
	SEDIMENT	8-6
	ACCESS	8-6
	NUISANCE CONDITIONS	8-6
8.2.9	BIOFILTRATION SWALES AND FILTER STRIPS	8-7
8.2.10	OIL/WATER SEPARATORS	8-7
	APPENDIX 8A - KITSAP COUNTY MAINTENANCE GUIDELINES	8A-1



# FIGURES & TABLES

## INDEX

<u>Figure</u>	<u>Title</u>	<u>Page</u>
FIGURE 3-1	STABILIZED CONSTRUCTION ENTRANCE	3B-2
FIGURE 3-2	NETS AND MATS	3B-11
FIGURE 3-3	SURFACE ROUGHENING TECHNIQUES	3B-18
FIGURE 3-4	STAIR-STEPPING CUT SLOPES AND GROOVING SLOPES	3B-19
FIGURE 3-5	SEDIMENT TRAP	3B-23
FIGURE 3-6	ESC STRUCTURAL PRACTICES	3B-25
FIGURE 3-7	SEDIMENT POND	3B-26
FIGURE 3-8	SEDIMENTATION POND BAFFLES	3B-27
FIGURE 3-9	FILTER FABRIC FENCE	3B-30
FIGURE 3-10	BRUSH BARRIER	3B-32
FIGURE 3-11	GRAVEL FILTER BERM	3B-34
FIGURE 3-12	STRAW/HAY BALE BARRIER	3B-37
FIGURE 3-13	STRAW BALE CHECK DAM	3B-38
FIGURE 3-14	FILTER FABRIC FENCE INLET BARRIER	3B-40
FIGURE 3-15	BLOCK AND GRAVEL FILTER INLET BARRIER	3B-42
FIGURE 3-16	GRAVEL AND WIRE MESH FILTER INLET BARRIER	3B-44
FIGURE 3-17	PIPE SLOPE DRAIN	3B-46
FIGURE 3-18	INTERCEPTOR DIKE/BERM AND SWALE	3B-49
FIGURE 3-19	SUBSURFACE DRAIN	3B-51
FIGURE 3-20	LEVEL SPREADER	3B-58
FIGURE 3-21	CHECK DAM	3B-61
FIGURE 5-1	ISOPLUVIAL MAP - 2 YR., 24 HR	5-6
FIGURE 5-2	" " - 5 YR., 24 HR.	5-7
FIGURE 5-3	" " - 10 YR., 24 HR.	5-8
FIGURE 5-4	" " - 25 YR., 24 HR.	5-9
FIGURE 5-5	" " - 50 YR., 24 HR.	5-10
FIGURE 5-6	" " - 100 YR., 24 HR.	5-11
FIGURE 5-7	" " - 100 YR., 7 DAY	5-12
FIGURE 5-8	VOLUME CORRECTION FACTOR	5-21
FIGURE 5-9	DEBRIS BARRIER DETAIL	5-23
FIGURE 5-10	GRAVEL FILTER WINDOW DETAIL	5-24
FIGURE 5-11	SECONDARY RISER STACK	5-26
FIGURE 5-12	EMERGENCY OVERFLOW SPILLWAY WEIR SECTION	5-28
FIGURE 5-13	POND SIGN DESIGN	5-29
FIGURE 5-14	TEXTURAL TRIANGLE (USDA)	5-31

FIGURE 5-15 BOLLARDS	5-33
FIGURE 5-16 DETENTION TANK DETAIL	5-35
FIGURE 5-17 DETENTION VAULT DETAIL	5-36
FIGURE 5-18 DETENTION TANK ACCESS RISER	5-39
FIGURE 5-19 SOLID LOCKING LID	5-40
FIGURE 5-20 ORIFICE LOCATION - TEE RISER	5-42
FIGURE 5-21 ORIFICE LOCATION - BAFFLE RISER	5-43
FIGURE 5-22 TEE SECTION WITH NOTCH WEIR & BAFFLE	5-44
FIGURE 5-23 TYPE 2 CATCH BASIN SUMP - INFILTRATION TRENCH	5-50
FIGURE 5-24 OBSERVATION WELL	5-51
FIGURE 5-25 INDIVIDUAL DOWNSPOUT INFILTRATION SYSTEM STANDARD DESIGN	5-52
FIGURE 5-26 OVERFLOW DEVICES	5-55
FIGURE 7-1 RAINFALL INTENSITY-DURATION CURVES	7-6
FIGURE 7-2 AVERAGE VELOCITIES	7-7
FIGURE 7-3 CONCRETE END PROTECTION	7-16
FIGURE 7-4 THRU-CURB INLET DETAIL	7-20

---

<u>TABLES</u>	<u>TITLE</u>	<u>PAGE</u>
TABLE 3-1	MULCH MATERIAL, APPLICATION RATES AND SPECIFICATIONS	3B-9
TABLE 3-2	TEMPORARY EROSION CONTROL SEED MIXTURE	3B-14
TABLE 3-3	PERMANENT EROSION CONTROL SEEDING MIXTURE	3B-16
TABLE 5-1	HYDROLOGIC SOIL GROUP	5-14
TABLE 5-2	MODIFIED CURVE NUMBERS	5-15
TABLE 5-3	MANNING'S COEFFICIENTS/"K" FACTORS	5-17
TABLE 5-4	SOIL INFILTRATION RATES BASED ON TEXTURAL ANALYSIS	5-48
TABLE 5-5	INDIVIDUAL DOWNSPOUT INFILTRATION SIZING CHART	5-53
TABLE 7-1	RUNOFF COEFFICIENTS-"C" VALUES FOR THE RATIONAL METHOD	7-5
TABLE 7-2	VALUES OF THE ROUGHNESS COEFFICIENT, "n", FOR PIPES	7-10
TABLE 7-3	VALUES OF THE ROUGHNESS COEFFICIENT, "N" FOR OPEN CHANNELS	7-11
TABLE 7-4	ROCK PROTECTION AT OUTFALLS	7-12
TABLE 7-5	APPROVED PIPE MATERIALS	7-14

# CHAPTER 1

## INTRODUCTION



# **CHAPTER 1**

## **INTRODUCTION**

### **CONTENTS**

1.1	CHANGING CIRCUMSTANCES	1-1
1.2	ADDITIONAL REFERENCES	1-1
1.3	PENALTIES AND ENFORCEMENT	1-2
1.4	EXISTING HAZARDS	1-3
1.5	ENGINEER'S RESPONSIBILITIES	1-3
	1.5.1 PROJECT ENGINEER'S RESPONSIBILITIES	1-3
	1.5.2 SOILS ENGINEER'S RESPONSIBILITIES	1-4
	1.5.3 GEOTECHNICAL ENGINEER'S RESPONSIBILITIES	1-5
1.6	TRANSFER OF ENGINEERING RESPONSIBILITY	1-5
1.7	COUNTY STAFF ASSISTANCE	1-5





# INTRODUCTION

The Kitsap County Stormwater Design Manual is included as Exhibit "A" of the Kitsap County Stormwater Management Ordinance. This manual has been greatly expanded from the previous Kitsap County Standards and Requirements on Drainage Plans and Drainage Analysis adopted in 1987.

## 1.1 CHANGING CIRCUMSTANCES

The changes included in this manual are primarily the result of the following circumstances:

1. The increasing urbanization of Kitsap County together with the continuing refinement of the Kitsap County Department of Public Works' understanding of "what works" has resulted in the need for some procedural changes.
2. Kitsap County is required by the Washington State Department of Ecology, together with the U.S. Environmental Protection Agency, to meet certain mandatory requirements in order to comply with the Clean Water Act, the Puget Sound Water Quality Plan, and the National Pollution Discharge Elimination System.
3. Technological advances in the field of stormwater quality and quantity control for the Puget Sound region have occurred since 1987, (e.g. work by the Center for Urban Water Resources Management at the University of Washington concerning biofiltration, and the almost universal move to a hydrograph method and flood routing method in designing runoff quantity control facilities). The County recognizes that it has a responsibility to adopt certain best management practices in the field of stormwater quality and quantity control that are currently accepted by the engineering and scientific community.

## 1.2 ADDITIONAL REFERENCES

There are a number of references and standards available which address stormwater management in the Puget Sound basin. Where conflicts exist between this manual and those other references or standards, this manual will prevail.

However, this manual does not attempt to include all design procedures and standards related to stormwater quantity and quality control. This is particularly true in its coverage of hydrological analysis methods. The design engineer is expected to refer, as necessary, to the following publications:

The Washington State Department of Ecology, Stormwater Management Manual for the Puget Sound Basin ("Technical Manual").

King County, Washington, Surface Water Design Manual.

The publication Technical Release 55: Urban Hydrology for Small Watersheds, 2nd Edition, together with a computer program on floppy disk, available from the National Technical Information Service, U.S. Department of Commerce, 5285 Port Royal Road, Springfield, Virginia 22161 [Telephone (703) 487-4650]. Request NTIS ACCESS # PB 87-101580/AS A08. This publication can be viewed and copied at the Kitsap County Conservation District Office in Port Orchard.

WSDOT/APWA Standard Specifications for Road, Bridge and Municipal Construction. Address orders for all WSDOT manuals to the Engineering Publications Branch, Transportation Building, Olympia, Washington 98504-5201, or telephone (360) 753-6028.

Washington State Department of Transportation Hydraulics Manual.

### **1.3 PENALTIES AND ENFORCEMENT**

Unless exempt from the terms of the Stormwater Management Ordinance, no person, firm, corporation or entity shall do any grading, filling, clearing, excavating, ditching, or create an impervious surface, unless the work is in accordance with a valid Site Development Activity Permit issued by Kitsap County. Each project site, which may be composed of one or more contiguous parcels of land, shall have a separate Site Development Activity Permit.

Kitsap County is authorized to make inspections and take such actions as required to enforce the provisions of the Stormwater Management Ordinance. The County has the authority to enter onto land for the purpose of inspection of site development activities or to perform any duty imposed upon the County by ordinance, provided that the County present proper credentials and make a reasonable effort to contact the property owner before entering onto that property.

The Director may require the owner of a site to remove any unpermitted or illegal facilities placed, constructed or installed on the site, and to implement a plan for the restoration or stabilization of the site or correct work that has adversely impacted adjacent or downstream property owners, with all costs borne by the owner.

Any person, firm or corporation violating any of the provisions of the Stormwater Management Ordinance, whether they be the property owner, the Applicant, the contractor, or any other person acting with or without the authorization of the property owner or

Applicant, shall be subject to the penalties prescribed in Section 11 of the Stormwater Management Ordinance.

#### **1.4 EXISTING HAZARDS**

Whenever the Director determines that any excavation, embankment, erosion/ sedimentation control or drainage facility has become a safety hazard; endangers property; or adversely affects the safety, use or stability of a public way, critical area, or drainage course, the owner of the subject property and/or the person or agent in control of the property will be required to repair or eliminate the hazard in conformance with the requirements of the Stormwater Management Ordinance and this manual. At the time that the Director makes the determination that a hazardous condition exists, the property owner and/or person or agent in control of the property will be notified in writing that the hazard exists. The Director will order the specific work to be undertaken or will order that an engineering design be submitted for review and approval by the Director, and will specify the time period within which the hazardous conditions be repaired or eliminated. In the event that the owner and/or the person or agent in control of the property fails to comply with this order, that person shall be subject to the penalties specified in the Stormwater Management Ordinance, Section 11.0.

#### **1.5 ENGINEER'S RESPONSIBILITIES**

Much of the information covered in this manual is addressed to professional engineers. In order to assist the professional engineer in fulfilling his/her responsibilities related to a development project, the following comments are included addressing Kitsap County's expectations regarding the responsibilities of the engineer:

##### **1.5.1 PROJECT ENGINEER'S RESPONSIBILITIES**

All engineered plans submitted to the Director for review and approval shall be prepared by a professional engineer, licensed in the State of Washington. The engineer shall be responsible for the following:

1. The engineer shall prepare site development construction plans and erosion and sedimentation control plans meeting the standards and requirements of the Stormwater Management Ordinance, including this manual. The engineer shall remain responsible for the accuracy, completeness and scope of all work submitted to the Director. Should errors, omissions or inaccurate data due to the engineer's work come to the Director's attention in the future, the engineer shall be responsible for correcting all deficiencies, when necessary, and shall be responsible for any damages resulting from the incorrect work.

2. The engineer shall incorporate recommendations from soils engineering reports, geotechnical engineering reports, and any other engineering recommendations into the site development construction plans and the erosion and sedimentation control plans.
3. The engineer shall, when required by the Director, be responsible for the professional inspection and approval of the construction within the engineer's area of technical expertise. This responsibility shall include, but need not be limited to, inspection and approval as to the establishment of line, grade, and drainage of the development area. In conjunction with the carrying out of this responsibility, copies of any on-site inspection reports shall be submitted by the engineer to the Director, when so requested.
4. The engineer shall act as the coordinating agent in the event the need arises for liaison between the owner, other professionals, contractors, the County, and other agencies.
5. The engineer shall be responsible for the preparation of revised plans and the submittal of as-built plans upon completion of work.
6. The engineer shall be responsible for verification of excavation and embankment quantities, detention/retention pond volumes, and slope steepness.

#### **1.5.2 SOILS ENGINEER'S RESPONSIBILITIES**

When a soils investigation report is required, the minimum responsibilities of the soils engineer shall be as follows:

1. The preparation of any required soils investigation report.
2. All reports, field data, test data, and recommendations shall be submitted to the Project Engineer and to the Director.
3. When required by the Project Engineer or the Director, the soils engineer shall provide professional inspection and approval concerning the preparation of ground to receive fills, testing for required compaction, stability of all finished slopes and the design of embankment fills, incorporating recommendations of the geotechnical engineer.
4. When required by the Project Engineer or the Director, the soils engineer shall prepare a final soils report which includes locations and elevations of field density tests, summaries of field and laboratory tests and other substantiating data and comments on any changes made during site development.

### **1.5.3 GEOTECHNICAL ENGINEER'S RESPONSIBILITIES**

When a geotechnical engineering report is required, the minimum responsibilities of the geotechnical engineer shall be as follows:

1. The preparation of any required geotechnical engineering investigation report.
2. All reports, field data, test data, and geotechnical engineering recommendations shall be submitted to the Project Engineer and to the Director.
3. When required by the Project Engineer or the Director, the geotechnical engineer shall provide professional inspection and approval concerning the adequacy of natural ground for receiving fills and the stability of cut or fill slopes with respect to geological matters, and the need for subdrains or other groundwater drainage devices.
4. When required by the Project Engineer or the Director, the geotechnical engineer shall prepare a final report following the completion of work, which includes a final description of the geology of the site including any new information disclosed during the site grading, and the effect of same on recommendations incorporated into the approved site development construction plans.
5. When required by the Director, the geotechnical engineer shall, following the completion of site grading, provide approval as to the adequacy of the site for the intended use as affected by geologic factors.

### **1.6 TRANSFER OF ENGINEERING RESPONSIBILITY**

For major developments, there shall at all times during the course of work be an engineer of record for the project performing the function of Project Engineer. If the engineer of record is changed during the course of the work, the work shall be stopped until the replacement engineer has agreed to accept the responsibilities of the Project Engineer.

### **1.7 COUNTY STAFF ASSISTANCE**

Kitsap County Department of Public Works staff is available to discuss or provide clarification for any of the matters addressed in this manual. Inquiries should be directed to:

Kitsap County Department of Public Works  
Stormwater Division  
614 Division Street MS-26  
Port Orchard, WA 98366-4699  
(360) 876-7121  
Fax: (360) 895-4867



## CHAPTER 2

# SUBMITTAL REQUIREMENTS





# CHAPTER 2

## SUBMITTAL REQUIREMENTS

### CONTENTS

2.1	INTRODUCTION	2-1
2.1.1	LARGE LOT SUBDIVISIONS	2-1
2.2	LAND USE PERMITS - PRELIMINARY	2-1
2.2.1	PRELIMINARY DRAINAGE REVIEW	2-2
	PRELIMINARY DRAINAGE PLAN - CONTENTS	2-2
	PRELIMINARY DRAINAGE REPORT - CONTENTS	2-4
2.3	SITE DEVELOPMENT ACTIVITY PERMIT	2-5
2.3.1	WHEN PERMIT REQUIRED	2-5
2.3.2	APPLICATION PROCESS	2-5
2.3.3	APPLICATION SUBMITTAL DOCUMENTS MINIMUM REQUIREMENTS	2-7
	ABBREVIATED PLAN	2-7
	EROSION AND SEDIMENTATION CONTROL PLAN	2-9
	ENGINEERED GRADING PLAN	2-10
	ENGINEERED DRAINAGE PLANS	2-11
	DRAINAGE REPORT	2-15
	DOWNSTREAM ANALYSIS	2-18
2.4	COVENANTS, SURETIES AND LIABILITY INSURANCE	2-20
2.4.1	SITE STABILIZATION	2-20
2.4.2	PERFORMANCE COVENANT FOR SITE STABILIZATION	2-20
2.4.3	PERFORMANCE SURETY FOR SITE STABILIZATION	2-21
2.4.4	PERFORMANCE BOND FOR UNCOMPLETED SITE IMPROVEMENTS	2-21
2.4.5	COMMERCIAL LIABILITY INSURANCE	2-22
2.4.6	MAINTENANCE BONDS	2-22
2.5	PRECONSTRUCTION MEETING	2-22
2.6	FINAL PROJECT APPROVAL	2-23
2.7	PROJECT PHASING	2-25

### APPENDIX 2A - KITSAP COUNTY STANDARD PLAN NOTES



# **SUBMITTAL REQUIREMENTS**

## **2.1 INTRODUCTION**

This chapter describes the requirements for submittal of plans and other documents for review by the Kitsap County Department of Public Works, Stormwater Division.

The requirements of this manual cover two basic types of reviews: preliminary drainage reviews and final review of construction plans.

- o Preliminary drainage reviews are a requirement for various land use applications and land use policies administered by the Kitsap County Department of Community Development.
- o Final review of construction plans and related documents is part of the Site Development Activity Permit process administered by the Department of Public Works, Stormwater Division prior to commencement of construction activities on a project site. Often, the application for a Site Development Activity Permit requires preliminary approval of a Land Use Permit application.

### **2.1.1 LARGE LOT SUBDIVISIONS**

Large Lot Subdivision approval is a Land Use Permit, issued by the Department of Public Works rather than the Department of Community Development. There is no Public Hearing required and usually a preliminary drainage review is not required. Instead, final construction plans shall be approved and all improvements constructed prior to the approval of the Large Lot Subdivision. Any site development activities required for a Large Lot Subdivision must conform to provisions of Ordinance 106-B (1990), Section 11, or the applicable ordinance regarding Large Lot Subdivisions in effect at the time.

## **2.2 LAND USE PERMITS - PRELIMINARY**

The preparation and submittal of any engineering plans, reports or supporting documents related to an application for Preliminary Land Use Approval shall be subject to current Kitsap County land use ordinances, and must comply with current policies of the Kitsap County Department of Community Development relating to Land Use Permit application procedures.

### **2.2.1 PRELIMINARY DRAINAGE REVIEW**

When, as part of a Land Use Permit application, a preliminary drainage review is required, the submittal requirements for such a drainage review shall be as follows:

All preliminary drainage review documents shall be submitted, along with other Land Use Permit application documents, to the Kitsap County Department of Community Development. The number of copies of documents to be submitted for the preliminary drainage review shall be determined by the Department of Community Development.

A preliminary review fee shall be paid to the Department of Public Works to cover the cost of that department's completion of the preliminary review. The amount of the preliminary review fee is included in the Kitsap County Site Development Activity Fee Schedule.

The preliminary review fee shall be paid two days prior to the deadline date for the placement of the legal ad for the public hearing. Otherwise, the public hearing date must be postponed.

Upon satisfactory completion of the preliminary drainage review, the Department of Public Works' recommended conditions of Preliminary Land Use Approval will be submitted to the Department of Community Development for inclusion in the Staff Report to the Hearing Examiner.

The preliminary drainage review documents shall include a Preliminary Drainage Plan and a Preliminary Drainage Report. The level of design shall be sufficient to demonstrate project feasibility. The contents of each are described as follows:

#### **PRELIMINARY DRAINAGE PLAN - CONTENTS**

1. Preferred sheet size is 24" x 36". Minimum sheet size is 18" x 24" and maximum sheet size is 36" x 48".
2. Title block, including name of proposed project/development.
3. North arrow indicator, drawing scale, Section-Township-Range.
4. The plan view of detailed drainage plans must be drawn at an engineering scale no smaller than 1" = 100'.
5. Professional Engineer's seal, signed and dated.
6. Vicinity map, showing project boundaries, streets with street names, shorelines if any, city limit boundaries if any, and distance to nearest intersection.

7. Legal description of project site.
8. Name, address and telephone number of project developer and property owner.
9. Name, address and telephone number of Project Engineer.
10. Symbol legend.
11. Property boundaries, dimensions, and area (in square feet or acres).
12. Contour lines, at maximum 5' intervals, with source to datum identified.
13. Adjoining street names and right-of-way widths.
14. Existing and proposed structures and other impervious surfaces such as parking lots, driveways, patios, buildings, etc.
15. Existing drainage facilities, such as pipes, catch basins, channels, ponds, etc.
16. Location of on-site and adjacent off-site waste treatment systems, such as septic tanks and distribution systems.
17. Existing and proposed utilities, with easements identified.
18. Established buffers, significant trees, and natural vegetation easements, if any.
19. Natural drainage channels, wetlands, water bodies, etc.
20. Areas where natural vegetation is to be left undisturbed.
21. The location of on-site and adjacent off-site wells and underground storage tanks.
22. An approximate plan for the collection and conveyance of stormwater through the project site. As a minimum, show by flow arrows the directions of proposed stormwater flow and indicate the method for conveyance (pipe, ditch, biofiltration swale, overland flow, etc.).
23. Proposed locations and sizes of stormwater quantity and quality control facilities.
24. Preliminary road profiles, showing existing grade and proposed finish grade.

## **PRELIMINARY DRAINAGE REPORT - CONTENTS**

1. Professional Engineer's seal, signed and dated.
2. Description of project location.
3. Description of pre-development site conditions.
4. Downstream drainage analysis - Level 1 Analysis (see description in this chapter).
5. Description of proposed development, including description of proposed developed site.
6. Description of proposed stormwater improvements, including conveyance, stormwater quantity control facilities, and stormwater quality control facilities.
7. Description of the design method utilized, names of any computer software routines utilized in the design process, and reference any design standards utilized (other than Kitsap County ordinances).
8. Preliminary hydrological analysis, including pre-development and post-development runoff hydrographs for the project site.
9. Preliminary sizing of storage facilities proposed for stormwater quantity and/or quality control.
10. Preliminary report addressing potential erosion and sedimentation impacts during construction, and general proposals for the mitigation of these impacts. (See Chapter 3, Erosion and Sedimentation Control).
11. Vicinity map, noting Section, Township and Range.
12. Pre-development and post-development basin maps, showing boundaries of project, any off-site contributing drainage basins, on-site drainage basins, time of concentration routes, approximate locations of all major drainage structures within the basins, and the course of stormwater originating from the subject property and extending all the way to Puget Sound or to the nearest receiving body of water (lakes, creeks, etc.). All basin maps must be legible and at a specified scale.
13. Other resource material such as soils maps, isopluvial maps, nomographs, charts, figures, tables, etc.

14. Surface/subsurface soil test results and test locations (when retention/infiltration is proposed).

## **2.3 SITE DEVELOPMENT ACTIVITY PERMIT**

### **2.3.1 WHEN PERMIT REQUIRED**

No site development activity, including land clearing, grading or other construction activity, shall take place on a development site prior to the issuance of a Site Development Activity Permit. Site development activities requiring a Site Development Activity Permit are listed in Section 3.2 of the Ordinance.

### **2.3.2 APPLICATION PROCESS**

Prior to commencing site development activities on a development site, the owner of the property shall submit to Kitsap County Department of Public Works a completed Site Development Activity Permit Application and await approval of proposed activities and issuance of the permit.

Following submittal of a Site Development Activity Permit Application, the Director will make a determination of what items shall be submitted for review prior to the issuance of the Site Development Activity Permit. When any items are required for submittal as part of a Site Development Activity Permit Application, **NINE copies (seven copies if sanitary sewers are not proposed)** of the final drainage plans and **TWO copies** of the final drainage report, checklists, analyses, etc. shall be submitted. Among the items that may be required for review, include the following:

1. **Abbreviated Plan (non-engineered):**

Required for site activities falling below the thresholds described in Section 3.23 of the Ordinance.

2. **Erosion and Sedimentation Control Plan.**
3. **Engineered Grading Plan**
4. **Engineered Drainage Plan if proposed activity is within a critical area: steep slope, etc.**
5. **Drainage Report**
6. **Downstream Analysis**

7. **SEPA Environmental Checklist:**

Required if: 1) estimated quantities of fill or excavation exceed 500 cubic yards, 2) if there is a pond, stream, creek, wetland or shoreline on the property to be graded, or 3) if the Kitsap County Department of Community Development determines that the proposed scope of work requires a SEPA review and an Environmental Checklist has not been previously submitted or reviewed for the proposed work. An application fee payable to Kitsap County DCD may be required for the SEPA checklist.

8. **Geotechnical Analysis or Soils Report, when required by Section 3.2 of the Ordinance.**

Following submittal of the required items, the Site Development Activity Permit Application will be scheduled for review. Applications that require only an Abbreviated Plan will be grouped with other applications requiring only an Abbreviated Plan and will be reviewed in the order received. All other applications will be grouped separately and will be reviewed in the order received among that group. In the event that, during the review of an application that included an Abbreviated Plan, it is determined that engineering will be required, the applicant will be notified of the specific requirements.

Once review has begun on an application, it will continue without further delay. In the event that additional information is required or revisions are necessary for items submitted, a time deadline will be given for the resubmittal of this information or revisions. As long as the information or revisions are submitted within this deadline, the review will continue without interruption. However, in the event that information or revisions are not submitted within the time deadline, the County may elect to suspend review. Once review has been suspended, priority will no longer be given to that application. Upon receipt of the information or revisions, review will again be scheduled as if it were a new application.

Upon the satisfactory completion of the application review, the required final construction plans will be marked "Accepted for Construction by Kitsap County".

The Site Development Activity Permit will then be issued, subject to the submittal of the following:

1. **Payment of all permit fees.**
2. **Evidence of issuance of any permits required by other agencies.**
3. **Performance bond, or Performance Covenant for Site Stabilization, as required by the Director.**



4. Evidence of liability insurance, as required by the Director.
5. Recording of any required off-site construction-related easements.

The requirement for a preconstruction meeting will be determined during review of the Site Development Activity Permit Application. This preconstruction meeting shall be scheduled with the Kitsap County Department of Public Works at the time of issuance of the Site Development Activity Permit.

If a preconstruction meeting is not required, a permit placard will be issued at the time of the Permit issuance. This placard shall be posted in clear view and be accessible on the project site. Work shall not commence until the permit placard has been properly posted on the site. The placard shall remain posted on the site throughout construction and may not be removed until all construction is completed and accepted by the Director.

In the event that a preconstruction meeting is required, the permit placard will be issued at the preconstruction meeting.

### **2.3.3 APPLICATION SUBMITTAL DOCUMENTS MINIMUM REQUIREMENTS**

#### **ABBREVIATED PLAN**

Abbreviated Plans need not bear the seal of a licensed professional engineer. The number of copies of the Abbreviated Plan to be submitted for review shall be determined by the Department of Public Works.

Following review of the Site Development Activity Permit Application for which an Abbreviated Plan has been submitted, the Department of Public Works may attach conditions to the project as deemed necessary to control erosion and runoff. These conditions may include, but not be limited to, the following:

- o Drainage control measures that the Director deems appropriate for the size of the project.
- o Erosion control best management practices and other measures as appropriate to meet the intent of this manual.
- o If the project would exacerbate existing or forecasted downstream flooding or water quality problems, or if the project drains to a closed depression, the Director may impose stormwater quality and quantity control measures and require an engineered Drainage and Erosion and Sedimentation Control Plan.

Plans shall be prepared utilizing a straight edge and features shall be drawn to scale. The drawing shall be sufficiently clear and of a large enough scale to clearly delineate the footprint of structures and other features described above.

The accepted Abbreviated Plan, together with the conditions imposed by the Department of Public Works following review of the application, shall be kept on the project site during construction and made available to the County's inspectors upon request.

The Abbreviated Plan shall contain the following information:

1. Name, address and telephone of the applicant, agent, or owner.
2. Name, address and telephone of the person preparing the plan.
3. Parcel number(s) and legal description of property.
4. Scale and north arrow.
5. Legend, if symbols are used that are not labeled in the plan.
6. Vicinity map of sufficient clarity to locate the property.
7. Property boundaries, dimensions, and area (in square feet or acres).
8. Contour lines from the best available source, spot elevations, or indications of direction and steepness of slopes, with the source clearly identified.
9. Adjoining street names.
10. Existing and proposed structures and other impervious surfaces such as parking lots, driveways, patios, buildings, etc.
11. Location of on-site and adjacent off-site waste treatment systems, such as septic tanks and distribution systems.
12. Existing and/or proposed utilities, with easements identified.
13. Established buffers, significant trees, and natural vegetation easements, if any.
14. Natural drainage channels, wetlands, water bodies, etc.
15. Proposed clearing limits.

16. Areas to be graded, filled, excavated, or otherwise disturbed. The location of graded slopes shall be indicated, together with the proposed steepness and height. The location of stockpiles, haul roads and disposal sites shall also be indicated.
17. The location of on-site and adjacent off-site wells, underground storage tanks, etc.
18. The location and type of erosion and sedimentation control measures proposed.

### **EROSION AND SEDIMENTATION CONTROL PLAN**

All Erosion and Sedimentation Control Plans shall be prepared by and bear the stamp of a professional engineer, licensed in the State of Washington. The Erosion and Sedimentation Control Plan shall include at least the following information:

1. Existing topography, as per the requirements for Engineered Drainage Plan listed below.
2. Clearing and grubbing limits.
3. Finished grade.
4. Locations of all existing and proposed channels, swales or drainage pipes which either convey offsite stormwater through or route stormwater around the construction area.
5. Locations of all proposed erosion and sedimentation control facilities.
6. Details of all proposed erosion and sedimentation control facilities.
7. The phasing of any erosion and sedimentation control work shall be clearly indicated on the Plan.
8. When sedimentation ponds are proposed, at least one cross section detail shall be shown.
9. Erosion and Sedimentation Control Plans shall include details and notes for mulching and revegetation. Plans shall also include detailed planting procedures, seed/plant specifications, and plant maintenance specifications.

11. Erosion and Sedimentation Control Plans shall include, as a minimum, the standard erosion and sedimentation control notes contained at the end of this chapter.
12. Erosion and Sedimentation Control Plans shall include the name, address and 24-hour contact telephone number(s) of the designated emergency contact person. In addition, Plans shall include the name, address and telephone number of the project owner and the Project Engineer.
13. Erosion and Sedimentation Control Plans shall include a detailed listing of the construction sequences.

### **ENGINEERED GRADING PLAN**

All Engineered Grading Plans shall be prepared by and bear the stamp of a professional engineer, licensed in the State of Washington. Engineered Grading Plans shall include at least the following information:

1. The plan view shall be no smaller than 1" = 100'. Recommended scales are 1" = 50' (Horizontal); 1" = 5' or 1" = 10' (Vertical).
2. The first sheet, or cover sheet if one is provided, shall include the following:
  - a. North arrow; vicinity map showing project boundaries; streets with street names; shorelines, if any; city limit boundaries, if any; and section-township-range. Reproductions of copyrighted materials without the permission of the owner(s) are not acceptable.
  - b. Legal description of project site.
  - c. Name, address and telephone of owner of project.
  - d. Name, address and telephone of Project Engineer.
  - e. Datum for project.
  - f. Legend, in the event that symbols are used in plans.
  - g. Existing topography, as per the requirements for a topographic map for Engineered Drainage Plans listed below.
3. The location of any soil test pits.

4. Clearing and grubbing limits.
5. Finished grade contours.
6. Locations of all existing channels, swales or drainage pipes which either convey offsite stormwater through the project site, or collect and discharge site runoff from the project site.
7. Locations of all existing slopes steeper than 2:1.
8. Information concerning wetlands, environmentally sensitive areas, water-courses, natural buffer areas and similar applicable information.
9. Locations of areas to be graded, filled, excavated, or otherwise disturbed. The location of tops and toes of graded slopes should be indicated, together with the proposed steepness and height of these slopes. The location of stockpiles, haul roads and disposal sites shall also be indicated.
10. Notations of quantities, in cubic yards, of excavation and/or fill throughout the project site.
11. Locations of drainage structures (pipes, channels, catch basins, ponds, etc.) which are to be constructed as a part of the grading plan.
12. Information concerning construction methods, fill material specifications, source of fill material, compaction information, haul routes, and other construction information when known and applicable.
13. Engineered Grading Plans shall include, as a minimum, the standard grading notes contained at the end of this chapter.
14. Engineered Grading Plans shall include a detailed schedule for inspections by Kitsap County.

#### **ENGINEERED DRAINAGE PLANS**

It is the responsibility of the Project Engineer to ensure that engineering plans are sufficiently clear and concise to construct the project in proper sequence, using specified methods and materials, with sufficient dimensions to fulfill the intent of the design guidelines contained in this manual.

All plan reproductions submitted for review must be of sufficient quality of reproduction, draftsmanship, line density, text size, and presentation of information to assure accurate recognition and understanding of plan details by reviewers and construction personnel.

Plans submitted for review which contain deficiencies in legibility or presentation of information which hinder the ability of personnel to properly evaluate proposed facilities will be returned to the Project Engineer and review will be suspended.

All Engineered Drainage Plans shall be prepared by and bear the stamp of a professional engineer, licensed in the State of Washington. The Engineered Drainage Plan shall contain the following information:

1. At least one sheet must contain a plan view of the entire project site. In the event the project site is sufficiently large that detailed drainage plans on any given sheet do not encompass the entire project site, then the sheet containing the plan view of the entire site must serve as an index to subsequent detailed plan sheets.
2. The plan view of detailed drainage plans shall be drawn at an engineering scale no smaller than 1" = 100'.
3. The first sheet, or cover sheet if one is provided, shall include the following:
  - a. Vicinity map, project boundaries; streets with street names; shorelines, if any; city limit boundaries, if any; and section-township-range. Reproductions of copyrighted materials without the permission of the owner(s) are not acceptable.
  - b. Legal description of project site.
  - c. Name, address and telephone of owner of project.
  - d. Name, address and telephone of Project Engineer.
  - e. Datum for project.
  - f. Legend, in the event that symbols are used in plans.
4. Plans shall include a topographic map showing existing conditions for the site, including:
  - a. Existing topography for the site and extending 50' beyond project boundaries. Existing topography for adjacent rights-of-way must be included for the full

width of right-of-way. Slopes steeper than 25% shall be identified by shading or cross-hatching.

- b. Contours extending 50' beyond project boundaries and including the full width of adjacent rights-of-way. Contours shall be at a maximum 5' vertical elevation intervals.
  - c. Locations and elevations of at least two bench marks in the project vicinity.
  - d. Existing structures, including all structures within 100' of project boundaries.
  - e. Existing access locations for the project site.
  - f. Existing project boundaries, rights-of-way, easements, jurisdictional boundaries, and sectional boundaries. All shall be clearly identified by note or symbol and key. Project boundaries shall include bearings and dimensions.
  - g. Adjacent streets, including street names, centerline and right-of-way boundaries, and centerline bearings. Widths of adjacent rights-of-way shall be noted.
  - h. Existing utilities, including franchised utilities located above or below ground and drainage facilities which transport surface water onto, across, or from the project site. Existing drainage pipes, culverts, and channels shall include invert or flowline elevations.
  - i. Existing environmentally sensitive areas (e.g. gullies, ravines, swales, wetlands, steep slopes, estuaries, springs, wetlands, creeks, lakes, etc.). For natural drainage features, show direction of flow and 100 year flood plain boundary (if applicable).
  - j. Existing wells, sanitary sewer systems, septic tanks and drainfields within 100' of project boundaries.
  - k. Existing fuel storage tanks.
5. Plans for proposed drainage improvements shall include the following:
- a. Finished grades. Show the extent of cuts and fills by existing and proposed contours, profiles and/or other explicit designations.
  - b. Existing structures to be removed.

- c. Proposed structures including roads and road improvements, parking surfaces, building footprints, walkways, landscape areas, etc. Exact lines, grades and gradients of proposed public roadways shall be shown.
  - d. Proposed lot boundaries, tracts, easements. Also, proposed changes to project boundaries, jurisdictional boundaries, rights-of-way boundaries.
  - e. Proposed utilities, showing exact line and grade of all proposed utilities at crossings with the proposed drainage system.
  - f. Proposed sanitary sewers, septic tanks, drainfields and water systems.
  - g. Proposed fuel storage tanks.
  - h. Setbacks from existing environmentally sensitive areas.
  - I. Proposed drainage structures, including pipes, open channels, culverts, ponds, vaults, biofiltration swales, infiltration facilities, outfalls, rip rap treatment, energy dissipators, etc.
  - j. Plan views of drainage conveyance facilities for which there is no accompanying profile view shall include the following information: pipe sizes, pipe types and materials, lengths of runs, gradients and exact locations of pipes or channels, structure identifier (e.g. catch basin/manhole number), type of structure (e.g. Type 2 CB), exact location of structures (e.g. station and offset, or dimensioning), invert elevations in/out of structures, and top elevations of structures. Notes shall be included referencing details, cross-sections, profiles, etc.
  - k. Locations of all gutter or ditch flowlines, including flow arrows indicating direction of flow. If a cul-de-sac is proposed as part of the roadway system, show spot flowline elevations at 25' intervals along the perimeter of the cul-de-sac. Spot elevations at flowlines may also be necessary at intersections.
  - l. Indicate any proposed phasing of construction.
6. In existing and proposed rights-of-way, drainage conveyance facilities shall be shown in profile view. Profile views shall include:
- a. Existing and finish grades.
  - b. Proposed drainage pipes, channels and structures.



- c. Existing underground utilities where such utilities cross proposed drainage facilities.
  - d. Profile views shall include the following information: pipe sizes, pipe types and materials, lengths of runs, gradients and exact locations of pipes or channels, structure identifier (e.g. catch basin/manhole number), type of structure (e.g. Type 2 CB), exact location of structures (e.g. station and offset, or dimensioning), invert elevations in/out of structures, and top elevations of structures. In order to minimize duplication of information where plan and profile views appear on the same sheet, drainage facility information provided in the plan view can be limited to the following: structure identifier, type of structure, pipe types and materials, and lengths of runs.
7. Construction notes shall appear on drainage plans. These notes shall include, as a minimum, the Drainage Notes included at the end of this chapter.
8. Details shall be provided for all proposed drainage structures for which there is insufficient information in the plan view. Details are not required for structures included in the APWA/WSDOT Standard Plans, provided that the specific APWA/WSDOT Standard Plans are referenced in the construction notes.
9. Cross sections shall be provided for at least the following:
- a. Roadways, including access roads.
  - b. Detention/retention ponds (including parking lot ponds and other multi-use facilities), wet ponds and sediment ponds.
  - c. Proposed ditches and swales, including biofiltration swales.

## **DRAINAGE REPORT**

The Drainage Report shall be on 8-1/2" x 11" paper and maps shall be folded to 8-1/2" x 11" size unless another format is approved prior to submittal.

The Drainage Report shall be prepared by and bear the stamp of a professional engineer licensed in the State of Washington and shall contain the following information:

1. Cover Sheet, including the project name, proponent's name, address and telephone number, Project Engineer, and date of submittal.

2. Table of Contents, showing the page numbers for each section of the report, including appendices.
3. Vicinity Map.
4. Project Description: Describe the type of permit(s) for which the proponent is applying, the size and location of the project site, address or parcel number and legal description of the property, property zoning, etc. Also describe other permits required (e.g. Hydraulic Project Approval, Corps of Engineers 404 Fill Permit, etc.). Describe the project, including proposed land use, proposed site improvements, proposed construction of impervious surfaces, proposed landscaping, etc.
5. Existing Conditions: Describe existing site conditions and relevant hydrological conditions including but not limited to: project site topography, land cover and land use; abutting property land cover and land use; offsite drainage to the property; creeks, lakes, ponds, wetlands, ravines, gullies, steep slopes, springs and other environmentally sensitive areas on or adjacent to the project site; the location of any wells both "of record" and others on the project site and on adjacent property within 100' of the project boundaries; the location of any existing fuel tanks, in-use or abandoned, within the project boundaries; general soils conditions present within the project site; whether or not the project site is located in a groundwater sensitive area (reference reports); existing natural and manmade drainage facilities within and immediately adjacent to the project site; points of discharge for existing drainage from the project site. Include references to relevant reports such as basin plans, flood studies, groundwater studies, wetland designation, sensitive area designation, environmental impact statements, lake restoration plans, water quality reports, etc. Where such reports impose additional conditions on the Proponent, those conditions shall be included in the report.
6. Developed Site Drainage Conditions: Describe the land cover resulting from the proposed project; describe the potential stormwater quantity and quality impacts resulting from the proposed project; describe the proposal for the collection and conveyance of site runoff from the project site, for the control of any increase in stormwater quantity resulting from the project, and for the control of stormwater quality.
7. Drainage Basin Description: Describe the drainage basin(s) to which the project site contributes runoff, and identify the receiving waters for each of these drainage basins.
8. Description of upstream basins, identifying any sources of runoff to the project site. This should be based on a field investigation. Any existing drainage or erosion problems upstream which may have an impact on the proposed development should be noted.

9. Downstream Analysis: (See detailed description below) The initial drainage report submittal must include a Level I Downstream Drainage Analysis, for review by the County. Any further analysis of downstream conditions required beyond the Level 1 analysis shall become a part of the drainage report and must be submitted as part of the Drainage Report.
10. Soils Report(s), where applicable, prepared by a qualified professional engineer.
11. Geotechnical Report(s), where applicable, prepared by a qualified professional engineer.
12. Hydrological Analysis
13. Basin Map(s), showing boundaries of project, any offsite contributing drainage basins, onsite drainage basins, approximate locations of all major drainage structures within the basins, and depict the course of stormwater originating from the subject property and extending all the way to Puget Sound or to the closest receiving body of water (lakes, creeks, etc.). Reference the source of the topographic base map (e.g. USGS), the scale of the map, and include a north arrow.
14. Hydraulic Design Computations, supporting the design of ALL proposed stormwater conveyance, quantity and quality control facilities, and verifying the capacity of existing and proposed drainage facilities. These computations may include capacity and backwater analysis required either as part of the proposed drainage design or as a part of the downstream drainage investigation, and flood routing computations required for the design of detention/retention storage facilities, for wetland impact analysis, or for flood plain analysis.
15. Erosion and Sedimentation Control Design Report and Computations, including the following: a description of proposed erosion control objectives and strategies; a description of erosion control facilities and other temporary water quality facilities proposed; a description of the revegetation plan for the project site; identification of areas of concern regarding soil stability and/or water quality impacts; computations for the sizing of temporary stormwater conveyance and quantity control facilities; computations for the design and sizing of proposed sediment containment facilities, etc.
16. Maintenance and Operation Manual: (See detailed description in chapter 8).
17. Appendices: Include the following: Experimental Water Quality BMP information per chapter 6.6; copies of any additional relevant reports, prepared by others, which support or corroborate the findings, conclusions, or assumptions contained in the drainage report; copies of any additional permits (or completed permit applications) required for the project.

the drainage report; copies of any additional permits (or completed permit applications) required for the project.

## **DOWNSTREAM ANALYSIS**

The Drainage Report submittal shall include a Level 1 downstream drainage analysis. This Level 1 analysis, as well as the location of the project in a drainage basin, will be reviewed by the County to determine whether a Level 2 and/or Level 3 downstream analysis will be required. Any further analysis of downstream conditions required beyond the Level 1 analysis shall become a part of the Drainage Report and must be submitted as part of the Drainage Report.

- o **Level 1 Analysis:** All proposed projects requiring a Site Development Activity Permit or Kitsap County Land Use Permit approval shall include at least this level of analysis with the permit application. The following steps should be completed for this level of analysis:
  1. Define and physically verify the study area. The upstream portion of the study area shall encompass the entire tributary drainage area (the area that drains to the proposed project site). The remaining portion of the study area shall extend downstream of the proposed project discharge location to a point on the drainage system where the proposed project site constitutes 15 percent or less of the total tributary area, but in no event less than 1/4 mile.
  2. Review all available resource information regarding existing and potential water quality, runoff volumes and rates, flooding and streambank erosion problems within the study area.
  3. Physically inspect the existing on-site and off-site drainage system problems reported in the resources.
  4. On a map (minimum USGS 1:24000 Quadrangle Topographic Map) delineate the study area, together with the drainage system onto and from the proposed site.
  5. Describe in a narrative form observations regarding the makeup and general condition of the drainage system.
  6. Include such information as pipe sizes, channel characteristics, and stormwater facilities.
  7. Identify on the map and describe any evidence of the types of existing or predicted problems listed below in Table 2-1. Following the review of the

Level 1 analysis, the County will determine whether a Level 2 analysis is required, based on the evidence of existing or predicted problems.

**Table 2-1 EVIDENCE OF EXISTING OR PREDICTED PROBLEMS**

1. Evidence of potential for contamination of surface waters.
2. Overtopping, scouring, bank sloughing or sedimentation.
3. Significant destruction of aquatic habitat or organisms (for example, severe siltation or incision in a stream).
4. Evidence of potential for contamination of ground water.

- o **Level 2 Analysis:** At the location of each existing or predicted water quality or quantity problem identified in the Level 1 analysis, provide a rough quantitative analysis to define and evaluate proposed mitigation for the problem. This analysis shall include the total composite drainage area tributary to that location for pre-development and post-development runoff conditions. For this level of analysis, it will be permissible to use non-survey field data (collected with hand tapes, hand level and rods, etc.) and approximate hydraulic computations using methods described in Chapter 7.
- o **Level 3 Analysis:** A Level 3 analysis shall be performed for those existing or predicted drainage problem locations where the Director determines that the analysis results must be as accurate as possible. Examples of conditions that might require a Level 3 analysis are: if the site is flat; if the system is affected by downstream controls; if minor changes in the drainage system could flood roads, buildings or septic systems; or if the proposed project will contribute more than 15 percent of the total peak flow to the drainage problem location. The Level 3 analysis is similar to the Level 2 analysis but is a more precise quantitative analysis, utilizing field survey profile and cross-section topographic data prepared by a licensed professional land surveyor or engineer.
- o **Solutions to Drainage Problems Identified by the Analysis:** For any existing or predicted off-site drainage problem, the Project Engineer shall demonstrate that the proposed plan has been designed so that it neither aggravates the existing problem nor creates a new problem. As an alternative, the applicant may arrange with the

owners of the affected off-site properties to install measures which will correct the existing or predicted problem, subject to all applicable permit requirements.

Any proposed drainage easements shall be endorsed by the affected property owners and be recorded prior to approval of the proposed plan. In some cases, an existing drainage problem identified by the local government may be scheduled for solution. In these cases, the applicant should contact the County to check for potential cost sharing to solve the existing problem.

For any predicted off-site problem, the Project Engineer shall demonstrate that the proposed plan has been designed to mitigate the predicted problem. As an alternative, the applicant may arrange with the owners of off-site properties to install measures which will mitigate the predicted problem. Any proposed drainage easements shall be endorsed by the affected property owners and be recorded prior to approval of the proposed plan.

## **2.4 COVENANTS, SURETIES AND LIABILITY INSURANCE**

### **2.4.1 SITE STABILIZATION**

Prior to the issuance of a Site Development Activity Permit and prior to beginning any construction activity on a project site, the owner of the project will be required to record a performance covenant or post a performance surety for site stabilization and erosion and sedimentation control. In addition, the owner may be required to provide a Certificate of Commercial Liability Insurance as outlined in Section 2.4.5 below.

This performance requirement for stabilization and erosion control should not be confused with the performance bond accepted at the time of final plat recording as a surety for construction items not yet completed. When a performance bond is accepted for a final plat in lieu of construction completion, the surety or covenant for stabilization and erosion control will be released, and the new performance bond shall cover site stabilization and erosion control along with the other incomplete construction items.

### **2.4.2 PERFORMANCE COVENANT FOR SITE STABILIZATION**

For project sites with less than 5 acres of land disturbing activity, a Performance Covenant may be recorded in lieu of performance surety for site stabilization prior to issuance of the Site Development Activity Permit to guarantee Kitsap County that temporary erosion and sedimentation control and permanent site stabilization measures will perform in accordance with the Stormwater Management Ordinance. This Covenant shall be recorded with the Kitsap County Auditor and shall run with the land until such a time as Kitsap County issues final acceptance of the permitted activities, or until a separate performance bond is posted

prior to final plat approval. Upon issuance of final project approval, the Department of Public Works will record a document that extinguishes the Performance Covenant.

If the site work is determined by the Director to be in violation of the Stormwater Management Ordinance, the County may enforce the Performance Covenant to provide temporary and permanent site stabilization.

#### **2.4.3 PERFORMANCE SURETY FOR SITE STABILIZATION**

The term "Bond" as defined in the ordinance shall mean a surety bond, assignment of funds, or irrevocable bank letter of credit. For project sites with 5 or more acres of land disturbing activity, a Performance Bond shall be posted prior to issuance of a Site Development Activity Permit to guarantee Kitsap County that temporary erosion and sedimentation control and permanent site stabilization measures will perform in accordance with the ordinance. The amount of the Performance Bond shall be as follows:

- o One hundred fifty percent (150%) of the estimated cost of performing minor grading and installing temporary erosion and sedimentation control, and permanent site stabilization measures to bring the construction site into compliance with the ordinance. A cost estimate shall be submitted by the project engineer subject to the approval of the Director. The minimum amount of the "Bond" shall be five thousand dollars (\$5000.00).

(OR)

- o One thousand dollars (\$1000.00) per acre of land disturbing activity. No engineer's estimate is required.

If the site work is determined by the Director to be in violation of the Stormwater Management ordinance, the County may use the Performance Bond to provide temporary and permanent site stabilization.

All Performance Bonds shall run continuously until released by the County, and shall not be subject to an expiration or cancellation date.

#### **2.4.4 PERFORMANCE BOND FOR UNCOMPLETED SITE IMPROVEMENTS**

For single family residential developments, a Performance Bond shall be provided prior to the final recording of the plat/PUD, guaranteeing completion of all site improvements not yet completed. The amount of the Performance Bond shall be one-hundred fifty percent (150%) of the estimated cost of said improvements. The estimated cost of the construction shall be determined by a qualified professional engineer subject to the approval of the Director.

All Performance Bonds shall run continuously until released by the County, and shall not be subject to an expiration or cancellation date.

#### **2.4.5 COMMERCIAL LIABILITY INSURANCE**

The owner of any project must provide a Certificate of Liability Insurance to the Department of Public Works prior to issuance of a Site Development Activity Permit. The liability insurance shall remain in force until final project approval is issued by the County. The commercial liability insurance shall be in the amount of not less than one million dollars (\$1,000,000.00) combined single limit bodily injury and property damage, with a two million dollar (\$2,000,000.00) aggregate. Such insurance shall include Kitsap County, its officers and employees as additional insureds, with respect to the terms and conditions of the policy.

#### **2.4.6 MAINTENANCE BONDS**

A maintenance bond is required for residential plats/PUD's and other projects for which maintenance of the stormwater facilities and/or roads is to ultimately be taken over by the County.

Prior to the final approval of construction and release of any performance sureties, a Maintenance Bond must be posted and maintained by the project owner for a period of two (2) years. The Maintenance Bond shall guarantee the stormwater facilities and roads constructed under permit against design defects and/or failures in workmanship, and shall guarantee that the facilities constructed under the permit will be regularly and adequately maintained throughout the maintenance period. At the end of this time, the County will inspect the system and, when the facility is acceptable and eighty percent (80%) of the lots in that phase have been improved, the County will take over the maintenance and operations of the system. In the event that eighty percent (80%) of the lots in a residential development have not been improved by the end of the two year maintenance period, the maintenance bond may be extended, subject to the approval of the Director, for one (1) additional year.

The amount of the Maintenance Bond shall be ten percent (10%) of the estimated construction cost of the stormwater facilities and roads requiring maintenance, or five thousand dollars (\$5000.00), whichever is greater. The construction cost of the facilities requiring maintenance shall be estimated by the Project Engineer, subject to the approval of the Director.

### **2.5 PRECONSTRUCTION MEETING**

When a preconstruction meeting is required prior to construction, such a meeting shall be attended by:



- o A representative of the owner.
- o The designated emergency contact person.
- o A representative of the general contractor.
- o A representative of Kitsap County Public Works.
- o Representatives from all affected utilities.

The agenda for the preconstruction meeting shall include at least the following:

- o Verification that all required permits have been issued.
- o Issuance of the Site Development Activity Permit placard, to be posted on the project site.
- o Verification that the contractor is in possession of current final approved plans.
- o Discussion of the duties of the designated emergency contact person.
- o Discussion of coordination of work by affected utilities.
- o Discussion of Kitsap County requirements concerning erosion control and construction sequence, inspection requirements, plan changes, and protection of critical drainage areas.

For projects where the Kitsap County Public Works Department has required a preconstruction meeting, no work shall take place on a project site prior to the preconstruction meeting.

In the event that work takes place on the project site prior to the preconstruction meeting, the owner and/or contractor shall be in violation of the Kitsap County Stormwater Management Ordinance and shall be subject to a monetary penalty as described in Section 11 of the Stormwater Management Ordinance. In addition, the issuance of the Site Development Activity Permit may be delayed and restoration work may be required for those areas of the site disturbed prematurely.

## **2.6 FINAL PROJECT APPROVAL**

Kitsap County Public Works will not recommend the approval of final plats or the granting of certificates of occupancy, and will not release financial securities until the following

applicable items have been completed: [It should be noted that performance bonds may be accepted in lieu of the items listed below, for final plats, in the event that the plat will be recorded prior to construction completion. However, in no event shall a performance bond be accepted for safety items such as guard rails or pond fencing.]

For permits requiring an Abbreviated Plan only:

- o Conditions of the Abbreviated Plan must be met, except that final landscape planting may be delayed to the appropriate season for said planting.

For permits requiring Engineered Drainage Plans, Erosion and Sedimentation Control Plans or Engineered Grading Plans:

1. Completion, to the satisfaction of the Director, of all work indicated on the plans.
2. Certification, by the Project Engineer, of the as-built live and dead storage pond volumes.
3. Certification, by the Project Engineer, that all pond side slopes are 2H:1V or flatter for fenced ponds, and 4H:1V or flatter for unfenced ponds.
4. Submittal of one set of reproducible mylar as-built plans along with two sets of blueprint copies. All sheets containing road and drainage plans, profiles and associated details shall be included in the as-built set. It is not necessary to include grading and erosion control plans and details. The as-built plan set shall be stamped "RECORD DRAWING" and shall be signed and stamped by a professional engineer or land surveyor.
5. Submittal of a recorded (with the Kitsap County Auditor) Maintenance Covenant for maintenance of private storm drainage facilities which gives Kitsap County the right to inspect the facilities and guarantees the County that the facilities will be properly maintained. A standard Maintenance Covenant form is available from the Department of Public Works.
6. Review and approval by the Department of Public Works of the final plat map and associated documentation.
7. Submittal of Recorded (with the Kitsap County Auditor) covenants, conditions and restrictions, maintenance easements, agreements with adjacent property owners, conservation easements, and similar documents as required in the approved plans, SEPA Conditions, or Conditions of Preliminary Approval.
8. Fulfillment of all conditions of approval.

9. Permanent stabilization and restoration of the project site. Final replanting may be delayed to the appropriate season, provided that temporary soil stabilization measures are in place and financial security is provided to assure the completion of work.
10. Submittal, by the Project Engineer, of the Operation and Maintenance Manual for privately maintained and/or non-standard stormwater facilities.
11. Payment of all outstanding fees.
12. Submittal of any required maintenance bonds.

## **2.7 PROJECT PHASING**

The phasing of construction is permitted when in accordance with current land use policies, conditions of Preliminary Approval, and SEPA conditions.

The Engineered Drainage Plan and the Erosion and Sedimentation Control Plan for the initial phase of a project shall incorporate all detention/retention facilities, water quality facilities, and erosion control facilities necessary to serve the initial phase as if no further construction were to take place (a "stand alone" project).

It is of particular importance that runoff control facilities be designed so that stormwater release rates for each phase do not exceed allowable release rates for a given stage of "build-out". It will sometimes be necessary that the control structure be modified with each additional construction phase. With the addition of each phase of development, the project must maintain its ability to "stand alone" without dependence on future phases of development.

In the event that the scope of the Engineered Drainage Plan and Erosion and Sedimentation Control Plan includes the entire project with all of its phases, plans must indicate the phasing limits for land clearing, erosion control, grading, construction of drainage facilities, and construction of impervious surfaces.



**APPENDIX 2A**  
**KITSAP COUNTY STANDARD PLAN NOTES**



## **Construction Sequence**

1. Apply for and pick up any right of way permits from Kitsap County Department of Public Works.
2. Construct stabilized construction entrance(s).
3. Construct filter fence barriers.
4. Construct sedimentation basins.
5. Construct runoff interception and diversion ditches.
6. Clear and grade the minimum site area required for construction of the various phases of work.
7. Provide temporary hydroseeding or other source control stabilization measures on all disturbed soils.
8. Maintain all erosion and sedimentation control facilities to provide the required protection of downstream water quality.
9. Provide permanent site stabilization.
10. Erosion and sedimentation control facilities shall not be removed until construction is complete and accepted by Kitsap County.

## **Drainage Notes**

1. The contractor shall ensure that the drainage is installed and operational prior to commencement of paving work.
2. All steel pipe and parts shall be galvanized. All submerged steel pipes and parts shall be galvanized and have asphalt treatment #1 or better.
3. Drainage stubouts on individual lots shall be located with a five foot high 2" x 4" stake marked "STORM". The stubout shall extend above surface level and be secured to the stake.

## **Temporary Erosion and Sedimentation Control Maintenance Requirements**

1. Erosion and sedimentation control facilities shall be inspected after each storm event and daily during prolonged rainfall.
2. Necessary repairs or replacement of facilities shall be accomplished promptly.
3. Sediment deposits shall be removed after each storm event or when the level of deposition reaches approximately one-half the maximum potential depth.
4. Sediment deposits remaining in place after the ESC facilities are no longer required shall be dressed to conform to the existing grade, prepared and seeded.
5. Temporary Erosion and Sedimentation Control facilities shall be maintained by:

## **Grading Notes**

1. The contractor shall notify the engineer in the event or discovery of poor soils, groundwater or discrepancies in the existing conditions as noted on the plans.
2. Maximum slope steepness shall be 2:1 Horizontal:Vertical for cut and fill slopes.
3. Unless otherwise specified, all embankments in the Plan Set shall be constructed in accordance with Section 2-03.3(14)B of the WSDOT Standard Specifications. Embankment compactions shall conform to Section 2-03.3(14)C, Method B of said Standard Specifications.
4. Embankments designed to impound water shall be compacted to 95% maximum density per section 2-03.3(14)C, Method C of WSDOT Standard Specifications.

5. All areas receiving fill material shall be prepared by removing vegetation, noncomplying fill, topsoil and other unsuitable material, by scarifying the surface to provide a bond with the new fill, and where slopes are steeper than 3 horizontal to 1 vertical and the height is greater than 5 ft., by benching into sound competent material as determined by a soils engineer.

### **General Notes**

1. All workmanship and materials shall conform to the MOST CURRENT Standard Specifications for Road, Bridge and Municipal Construction prepared by WSDOT and APWA as adopted by the Kitsap County Department of Public Works (KCPW).
2. Any revisions to the accepted construction plans shall be reviewed and approved by the County prior to implementation in the field.
3. The contractor shall maintain a set of the accepted construction drawings on-site at all times while construction is in progress.
4. It shall be the responsibility of the contractor to obtain all necessary permits from the KCPW prior to commencing any work within County right-of-way.
5. The contractor shall be responsible for providing adequate traffic control at all times during construction alongside or within all public roadways. Traffic flow on existing public roadways shall be maintained at all times, unless permission is obtained from the KCPW for road closure and/or detours.
6. The locations of existing utilities on this plan is approximate only. The contractor shall contract the "Underground Locate" center at Ph: 1-800-424-5555, and non-subscribing individual utility companies 48 hours in advance of the commencement of any construction activity. The contractor shall provide for protection of existing utilities from damage caused by the contractor's operations.
7. Rockeries or other retaining facilities exceeding 4 ft. in height require a separate permit
8. A "Forestry Practices" permit may be required prior to clearing of the site.

### **Inspection Schedule**

The Contractor shall notify Community Development to arrange for inspection of the various phases of work checked below. All inspections shall be completed prior to proceeding with the next phase of work.

1. Clearing limits.
2. Implementation of the various phases of the Erosion and Sedimentation Control Plan.
3. Placement of drainage structures prior to back filling, including pond embankments.
4. Prior to placement of the detention outlet control structure (orifice size verified).
5. Inspection of prepared sub-grade.
6. Inspection of gravel base placement.
7. Inspection of fine grading prior to paving.
8. Inspection of paving operations.
9. Final inspection.



The Contractor shall be responsible for all work performed and shall ensure that construction is acceptable to Kitsap County.

If inspection is not called for prior to completion of any item of work so designated, special destructive and/or non-destructive testing procedures may be required to ensure the acceptability of the work. If such procedures are required, the Contractor shall be responsible for all costs associated with the testing and/or restoration of the work.

### **General Erosion and Sedimentation Control Notes**

1. The following erosion and sedimentation control notes apply to all construction site activities at all times, unless otherwise specified on these plans:
2. Approval of this erosion and sedimentation control plan does not constitute an acceptance of the permanent road or drainage design.
3. The owner and his/her contractor shall be responsible at all times for preventing silt-laden runoff from discharging from the project site. Failure by the owner and/or contractor can result in a fine. The designated temporary contact person noted on this plan must be available for contact by telephone on a 24 hour basis throughout construction and until the project has been completed and accepted by the county.
4. The implementation of these ESC plans and the construction, maintenance, replacement and upgrading of these facilities is the responsibility of the owner and/or contractor from the beginning of construction until all construction is completed and accepted by the county and the site is stabilized.
5. Prior to beginning any work on the project site, a preconstruction conference must be held, and shall be attended by the general contractor, the project engineer, representatives from affected utilities, and a representative of Kitsap County.
6. The erosion and sedimentation control facilities shown on this plan are to be considered adequate basic requirements for the anticipated site conditions. During construction, deviations from this plan may be necessary in order to maintain water quality. Minor departures from this plan are permitted subject to the approval of the county inspector. However, except for emergency situations, all other deviations from this plan must be designed by the project engineer and approved by Kitsap County prior to installation.
7. All erosion and sedimentation control measures shall be inspected by the owner and/or contractor on a frequent basis and immediately after each rainfall, and maintained as necessary to insure their continued functioning. All sediment must be removed from silt fences, straw bales, sediment ponds, etc. prior to the sediment reaching 2 its maximum potential depth.
8. At no time shall concrete, concrete by-products, vehicle fluids, paint, chemicals, or other polluting matter be permitted to discharge to the temporary or permanent drainage system, or to discharge from the project site.
9. Permanent detention/retention ponds, pipes, tanks or vaults may only be used for sediment containment when specifically indicated on these plans.

### **Minimum Erosion and Sedimentation Control Requirements**

1. **Stabilization and sediment trapping.** All exposed and unworked soils, including soil stockpiles, shall be stabilized by suitable application of BMPs that protect soil from the erosive forces of raindrop impact and flowing water. Applicable practices include, but are not limited to vegetative establishment, mulching, plastic covering, and the early application of gravel base on areas to be paved. From October 1 to April 30, no soils shall remain

- unstabilized for more than 2 days. From May 1 to September 30, no soils shall remain unstabilized for more than 7 days.
2. At all times of the year, the contractor shall have sufficient materials, equipment and labor on-site to stabilize and prevent erosion from all denuded areas within 12-hours as site and weather conditions dictate.
  3. From October 1st to April 30th, the Project Engineer shall visit the development site a minimum of once per week for the purpose of inspecting the erosion and sedimentation control facilities, reviewing the progress of construction, and verifying the effectiveness of the erosion control measures being undertaken. The Project Engineer shall immediately inform the County of any problems or potential problems observed during said site visits, as well as of any recommended changes in the erosion control measures to be undertaken. When requested by the County, the Project Engineer shall provide the County with written records of said weekly site visits, including dates of visits and noted site observations.
  4. In the event that ground on a project site is left bare after September 30th, the County may issue a Stop Work Order for the entire project until satisfactory controls are provided. In addition, the Owner will be subject to the penalties provided in Section 12.32 of the Kitsap County Code.
  5. In the event that ground on a project site is left bare after September 30th, and the County is unsuccessful in contacting the Owner or his/her designated emergency contact person, the County may enter the project site and install temporary ground cover measures and bill the Owner for all expenses incurred by the County. These costs will be in addition to any monetary penalties levied against the Owner.
  6. Delineation of clearing and easement limits. Clearing limits, setbacks, buffers, and sensitive or critical areas such as steep slopes, wetlands and riparian corridors shall be clearly marked in the field and inspected by Kitsap County Department of Community Development prior to commencement of land clearing activities.
  7. Protection of adjacent properties. Adjacent properties shall be protected from sediment deposition by appropriate use of vegetative buffer strips, sediment barriers or filters, dikes or mulching, or by a combination of these measures and other appropriate BMPs.
  8. Timing and stabilization of sediment trapping measures. Sediment ponds and traps, perimeter dikes, sediment barriers and other BMPs intended to trap sediment on-site shall be constructed as a first step in grading. These BMPs shall be functional before land disturbing activities take place. Earthen structures such as dams, dikes, and diversions shall be stabilized according to the timing indicated in item (1) above.
  9. Slope Stabilization. Cut and fill slopes shall be constructed in a manner that will minimize erosion. Roughened soil surfaces are preferred to smooth surfaces. Interceptors should be constructed at the top of long, steep slopes which have significant areas above that contribute runoff. Concentrated runoff should not be allowed to flow down the face of a cut or fill slope unless contained within an adequate channel or pipe slope drain. Wherever a slope face crosses a water seepage plane, adequate drainage or other protection should be provided. In addition, slopes should be stabilized in accordance with item (1) above.
  10. Controlling off-site erosion. Properties and waterways downstream from development sites shall be protected from erosion due to increases in the volume, velocity, and peak flow rate of stormwater runoff from the development site by the implementation of appropriate BMPs to minimize adverse downstream impacts.

11. Stabilization of temporary conveyance channels and outlets. All temporary on-site conveyance channels shall be designed, constructed and stabilized to prevent erosion from the expected flow velocity from a 2-year frequency, 24-hour duration storm for the post-development condition. Stabilization adequate to prevent erosion of outlets, adjacent streambanks, slopes and downstream reaches shall be provided at the outlets of all conveyance systems.
12. Storm drain inlet protection. All storm drain inlets made operable during construction shall be protected so that stormwater runoff shall not enter the conveyance system without first being filtered or otherwise treated to remove sediment. After proper written application, the requirement for inlet protection may be waived by the County on a site-specific basis when the conveyance system downstream of the inlet discharges to an appropriate sediment containment BMP and the conveyance system can be adequately cleaned following site stabilization.
13. Underground utility construction. The construction of underground utility lines shall be limited, where feasible, to no more than 500 feet of open trench at any one time. Where consistent with safety and space considerations, excavated material shall be placed on the uphill side of the trench. Dewatering devices shall discharge to an appropriate sediment trap or pond, preceded by adequate energy dissipation, prior to runoff leaving the site.
14. Constructed access routes. Wherever construction vehicle access routes intersect paved roads, provisions must be made to minimize the transport of sediment (mud) onto the paved road by use of appropriate BMP's such as a Stabilized Construction Entrance. If sediment is transported onto a road surface, the roads shall be cleaned thoroughly, as a minimum, at the end of each day. Sediment shall be removed from roads by shoveling or sweeping and be transported to a controlled sediment disposal area. Street washing shall be allowed only after sediment is removed in this manner.
15. Removal of temporary BMPs. All temporary erosion and sediment control BMPs shall be removed within 30 days after final site stabilization is achieved or after the temporary BMPs are no longer needed. Trapped sediment shall be removed or stabilized on-site. Disturbed soil areas resulting from removal of temporary BMPs shall be permanently stabilized. The removal of temporary erosion and sediment control BMPs may not be required for those projects, such as single family plats, that will be followed by additional construction under a different permit. In these circumstances, the need for removing or retaining the measures will be evaluated on a site-specific basis.
16. Dewatering construction sites. Dewatering devices shall discharge into an appropriate sediment trap or pond, designed to accept such a discharge, preceded by adequate energy dissipation, prior to runoff leaving the site.
17. Control of pollutants other than sediment on construction sites. All pollutants other than sediment that occur on-site during construction shall be handled and legally disposed of in a manner that does not cause contamination of storm or surface waters. Pollutants of concern include, but are not limited to, fuels, lubricants, solvents, concrete bi-products and construction materials
18. Maintenance. All temporary and permanent erosion and sediment control BMPs shall be maintained and repaired as needed to assure continued performance of their intended function. All maintenance and repair shall be conducted in accordance with the Manual. The Applicant shall be responsible for assuring that any such facilities damaged during floods,

storms or other adverse weather conditions are immediately returned to normal operating condition.

19. **Financial liability.** A performance covenant or performance surety, shall be required for all projects to ensure compliance with the approved erosion and sediment control plan, as outlined in Section 12.14 of the Kitsap County Code.

### **Biofiltration Swale Notes:**

The biofiltration swale shall be lined with a minimum of 4 inches of Type A topsoil according to WSDOT/APWA Standard Specifications.

The swale should be seeded, fertilized and mulched according to the recommendations of the local Soil Conservation District as follows:

#### Seed Mixture:

70% Tall Fescue (Alta, Boyager, Orfawn)  
20% Perennial Rye  
10% White Clover

#### Application Rate (per 1000 square foot):

5 lbs. Seed  
7 lbs. Fertilizer (10-20-20)  
50 lbs. Wood Fiber Mulch

The contractor may be required to provide the County inspector with documentation for the seed mixture used.

Seeding of the swale should be performed between March 1 - May 15 or August 15 - October 1 according to WSDOT/APWA Standard Specifications, with the exception that seeding may be performed from May 16 - September 30 if irrigation is provided.

Sodding of the swale will be allowed provided that the sod meets the seed mixture specifications listed above, or if the sod is over seeded with the appropriate seed mixture at the next available planting time.

Paving shall not occur until the biofiltration swale is sodded or the seed has germinated and produced at least 2 inches of growth over 85% of the swale surface.

## CHAPTER 3

# EROSION AND SEDIMENTATION CONTROL



# CHAPTER 3

## EROSION AND SEDIMENTATION CONTROL

### CONTENTS

3.1	OVERVIEW	3-1
3.1.1	EROSION AND SEDIMENTATION	3-1
	EROSION	3-1
	SEDIMENTATION	3-2
	IMPACTS OF EROSION AND SEDIMENTATION	3-2
3.2	MINIMUM REQUIREMENTS	3-3
3.2.1	PERFORMANCE	3-3
3.2.2	DESIGN STORM	3-4
3.2.3	MINOR DEVELOPMENTS	3-4
3.2.4	MAJOR DEVELOPMENTS	3-5
3.2.5	EROSION AND SEDIMENTATION CONTROL PLAN	3-8

APPENDIX 3A - ESC BEST MANAGEMENT PRACTICES REFERENCE GUIDE

APPENDIX 3B - ESC BEST MANAGEMENT PRACTICES





# FIGURES & TABLES

## INDEX

<u>Figure</u>	<u>Title</u>	<u>Page</u>
FIGURE 3-1	STABILIZED CONSTRUCTION ENTRANCE	3B-2
FIGURE 3-2	NETS AND MATS	3B-11
FIGURE 3-3	SURFACE ROUGHENING TECHNIQUES	3B-18
FIGURE 3-4	STAIR-STEPPING CUT SLOPES AND GROOVING SLOPES	3B-19
FIGURE 3-5	SEDIMENT TRAP	3B-23
FIGURE 3-6	ESC STRUCTURAL PRACTICES	3B-25
FIGURE 3-7	SEDIMENT POND	3B-26
FIGURE 3-8	SEDIMENTATION POND BAFFLES	3B-27
FIGURE 3-9	FILTER FABRIC FENCE	3B-30
FIGURE 3-10	BRUSH BARRIER	3B-32
FIGURE 3-11	GRAVEL FILTER BERM	3B-34
FIGURE 3-12	STRAW/HAY BALE BARRIER	3B-37
FIGURE 3-13	STRAW BALE CHECK DAM	3B-38
FIGURE 3-14	FILTER FABRIC FENCE INLET BARRIER	3B-40
FIGURE 3-15	BLOCK AND GRAVEL FILTER INLET BARRIER	3B-42
FIGURE 3-16	GRAVEL AND WIRE MESH FILTER INLET BARRIER	3B-44
FIGURE 3-17	PIPE SLOPE DRAIN	3B-46
FIGURE 3-18	INTERCEPTOR DIKE/BERM AND SWALE	3B-49
FIGURE 3-19	SUBSURFACE DRAIN	3B-51
FIGURE 3-20	LEVEL SPREADER	3B-58
FIGURE 3-21	CHECK DAM	3B-61

---

<u>TABLES</u>	<u>TITLE</u>	<u>PAGE</u>
TABLE 3-1	MULCH MATERIAL, APPLICATION RATES AND SPECIFICATIONS	3B-9
TABLE 3-2	TEMPORARY EROSION CONTROL SEED MIXTURE	3B-14
TABLE 3-3	PERMANENT EROSION CONTROL SEEDING MIXTURE	3B-16



# **EROSION AND SEDIMENTATION CONTROL**

## **3.1 OVERVIEW**

Each year in Kitsap County large amounts of sediment are washed from construction sites into lakes, streams, water courses and Puget Sound. Sedimentation is a major source of pollution of the surface water draining from watersheds in which development is occurring. This needless damage to our water resources and the consequent cost to the taxpayers of Kitsap County for cleanup could be largely avoided through the implementation of adequate erosion and sediment control practices.

This chapter contains requirements and standards for erosion and sedimentation control (ESC) recommended by Kitsap County. Also, this chapter contains information on the purpose for various erosion and sedimentation control practices, the site conditions where these practices are appropriate, and the recommended design criteria for their construction and maintenance.

### **3.1.1 EROSION AND SEDIMENTATION**

#### **EROSION**

The likelihood that a given construction area has the potential for serious erosion is largely dependent on three things: the characteristics of the soils, the extent and type of vegetative cover, and the topography of the site.

Soils containing high percentages of fine sands and silts are usually more erodible than soils that have a higher content of clay or organic material. Although clays are more resistant to erosion, they absorb less rainfall and tend to produce more surface runoff, which acts to erode the soil. Once clays have eroded, they are more likely to be carried along in the runoff and are difficult to remove from the surface water. Soils with high organic content tend to be more resistant to erosion. However, they are resistant to infiltration and are often found in areas likely to impound water. Well-drained and well-graded gravel and gravel-sand mixtures are usually the least erodible soils.

Vegetative cover is very important in controlling erosion by 1) shielding the soil surface from the impact of falling rain, 2) by holding the soil particles in place, 3) by maintaining the soil's capacity to absorb water, and 4) by slowing the flow of runoff over the ground. By minimizing the size of the areas to be cleared, and by staging the removal of vegetation, the extent of erosion and the time during which erosion can take place is also kept to a minimum. By establishing temporary and permanent vegetative cover for those areas that are disturbed, soil erosion and the resulting sedimentation downstream can be significantly reduced.

The size, shape and slope of the watershed that the construction site is a part of influences the amount and rate of runoff through the site. If the site is downstream of a large watershed,

or if the site itself is sizable, there is the potential for a considerable amount of runoff to be flowing through the site during a storm. If the site has steep slopes, the velocity of the runoff will be greater, resulting in a higher potential for erosion.

The site's orientation can also be a factor. If the site faces to the north away from the sun (or if the site has poor soils for growing plants), it may be very difficult to establish a permanent vegetative cover following construction. For this reason, it is important to take into consideration the natural development of existing vegetation on a site prior to clearing. Hydroseeding a site is no guarantee that plant life will become re-established to the extent that erosion protection can take place without costly maintenance and periodic replanting.

## SEDIMENTATION

Sediments are the fine particles of soil which are carried in surface runoff and which are eventually deposited after the water has slowed down enough for the soil particles to settle out. Excessive amounts of sediment are generated by erosion during major storm events. Some erosion and sedimentation occurs during all storm events. Sediment is often carried farther downstream with each peak storm event, being picked up from where it was deposited during the previous peak storm. For this reason, it is important to bear in mind that the facilities that are placed on a site to collect sediment (silt fencing, ponds, etc.) are going to be primary sources of sediment in later storms.

Most soils in Kitsap County contain fine silt which, when suspended in water, remains suspended for long periods of time and does not immediately settle out once the flow of water slows down. Suspended silt usually gives water an opaque, light brown appearance, a condition called "turbidity". This condition is harmful to plants in that it inhibits photosynthesis, which in turn reduces food supply and habitat to fish. Turbid stream water can also directly affect some species of fish that rely on their vision for feeding. Silt suspended in stormwater so as to cause turbidity is a violation of Section 10 of the Stormwater Management Ordinance and R.C.W. 90.48.

## IMPACTS OF EROSION AND SEDIMENTATION

Erosion and sedimentation can cause both economic and environmental impacts:

1. Economic Impacts:
  - a. Sediment fills channels and ponds, resulting in the need for more frequent sediment removal, and also resulting in the increased likelihood of damage to property from flooding.
  - b. Cost of restoration of topsoil to promote plant growth.
  - c. Cost of restoration of eroded slopes, channels and roads.

- d. Cost to clean storm sewers, catch basins and other drainage facilities.
- e. Cost to clean up downstream channels, lakes, streams and wetlands.

## 2. Environmental Impacts

- a. Eroded soil contains nutrients which could trigger the growth of algae, which then reduces water clarity, depletes oxygen, and leads to fish kills.
- b. Erosion of stream banks and adjacent areas destroys vegetation that provides aquatic and wildlife habitat.
- c. Excessive deposits of sediment in streams blanket the bottom, destroying fish spawning areas.
- d. Turbidity of the water, resulting from sedimentation, reduces in-stream photosynthesis, which leads to reduced food supply and habitat.
- e. Erosion removes the fines from topsoil, reducing its ability to support plant growth.
- f. Sediment physically damages fish by abrasion and clogging of their gills.

## 3.2 MINIMUM REQUIREMENTS

Section 5.30 of the Kitsap County Stormwater Management Ordinance requires that all new major developments and redevelopments comply with the erosion and sedimentation control requirements specified. Section 10.20 of the Ordinance states that it is a violation for any person to cause the pollution of any waters of Kitsap County. Section 10.22 of the Ordinance states that the owners of erosion control devices must operate and maintain such control devices in a manner which will prevent discharge of pollutants to waters of Kitsap County. Finally, Section 11.30 of the Ordinance states that a violation of the water quality provisions of the Ordinance will result in a penalty to the violator (whether owner or contractor) of up to \$1,000 per offense per day.

### 3.2.1 PERFORMANCE

The erosion and sedimentation control measures shall perform so that no sediment larger than a #200 sieve, ( 0.075 mm) leaves the site or enters on-site wetlands, streams or lakes. "Leaves the site" shall be interpreted liberally. For example, if the standard is applied to individual lots within a subdivision, it may, depending on the site, be appropriate to apply the standard at the outlet of the drainage system rather than at the edge of the lot. If the site does not meet this standard, any measures or areas that do not comply with the minimum requirements shall be brought into compliance. If the standard is exceeded, even though the

site is in compliance with the minimum requirements, the county may require additional measures. Additionally, if at any time the County determines that the existing construction site may pose a hazard to adjacent property or may adversely impact drainage facilities or water resources, even though the performance standard is being met, the county can require measures beyond those in the minimum requirements. The County can require that the erosion control supervisor have a #200 sieve on site.

It should be noted that even if the performance standard is met, the project must still be in compliance with the minimum requirements. The performance standard is intended to be used to pinpoint problems, not to measure success. Most projects will be able to easily meet the performance standard if the project is in compliance with the minimum requirements.

### **3.2.2 DESIGN STORM**

Unless otherwise specified, the design storm event for erosion and sedimentation control BMPs shall be the 2-year, 24-hour storm event.

### **3.2.3 MINOR DEVELOPMENTS**

Developments are considered by Kitsap County to be "minor developments" when they (a) result in the creation or addition of less than 5,000 square feet of impervious surface area, (b) are site disturbing activities of less than 1 acre, and (c) result in the grading of less than 5,000 cubic yards of material.

Minor Developments are required to control erosion and sedimentation during construction, to permanently stabilize soil exposed during construction, and to comply with the following Minor Development Requirements:

1. Construction access route. Construction vehicle access shall be, whenever possible, limited to one route. Access points shall be stabilized with quarry spall or crushed rock to minimize the tracking of soils and debris onto public roads.
2. Stabilization of denuded area. All exposed soils shall be stabilized by suitable application of BMPs, including but not limited to, sod or other vegetation, mat covering, mulching, or application of compacted ground base material on areas to be paved. All BMPs shall be selected, designed and maintained in accordance with the Manual. From October 1 to April 30, no soils shall remain unstabilized for more than 2 days. From May 1 to September 30, no soils shall remain unstabilized for more than 7 days.

At all times of the year, the contractor shall have sufficient materials, equipment and labor on-site to stabilize and prevent erosion from all denuded areas within 12-hours as site and weather conditions dictate.

3. **Protection of adjacent properties.** Adjacent properties shall be protected from sediment deposition by appropriate use of vegetative buffer strips, sediment barriers or filters, dikes or mulching, or by a combination of these measures and other appropriate BMPs.
4. **Maintenance.** All erosion and sediment control BMPs shall be regularly inspected and maintained to ensure continued performance of their intended function.
5. **Other BMPs.** Any adverse effects of increased runoff resulting from land disturbing and/or land development activities shall be controlled by appropriate BMP's.

Minor Developments may require an erosion and sedimentation control plan when a Site Development Activity Permit is required pursuant to Section 3.20 of the Ordinance.

### **3.2.4 MAJOR DEVELOPMENTS**

Developments and redevelopment activities are considered by Kitsap County to be "major developments" which include the creation or addition of 5,000 square feet or greater of new impervious surface area, result in the displacement of 5,000 cubic yards or more of material, or involve land disturbing activities on greater than 1 acre.

Major Developments will be required to control erosion and sediment during construction, to permanently stabilize soil exposed during construction, and to comply with the following Major Development Requirements:

#### **MINIMUM EROSION AND SEDIMENTATION CONTROL REQUIREMENTS**

1. **Stabilization and sediment trapping.** All exposed and unworked soils, including soil stockpiles, shall be stabilized by suitable application of BMPs which protect soil from the erosive forces of raindrop impact and flowing water. Applicable practices include, but are not limited to vegetative establishment, mulching, plastic covering, and the early application of gravel base on areas to be paved. From October 1 to April 30, no soils shall remain unstabilized for more than 2 days. From May 1 to September 30, no soils shall remain unstabilized for more than 7 days.

At all times of the year, the contractor shall have sufficient materials, equipment and labor on-site to stabilize and prevent erosion from all denuded areas within 12-hours as site and weather conditions dictate.

From October 1st to April 30th, the Project Engineer shall visit the development site a minimum of once per week for the purpose of inspecting the erosion and sedimentation control facilities, reviewing the progress of construction, and verifying the effectiveness of the erosion control measures being undertaken. The Project Engineer shall immediately inform the Director of any problems or potential problems observed during said site visits, as well as of any recommended changes

in the erosion control measures to be undertaken. When requested by the Director, the Project Engineer shall provide the Director with written records of said weekly site visits, including dates of visits and noted site observations.

In the event that ground on a project site is left bare after September 30th, the County may issue a Stop Work Order for the entire project until satisfactory controls are provided. In addition, the Owner will be subject to the penalties provided in Section 10 and Section 11 of the Kitsap County Stormwater Ordinance.

In the event that ground on a project site is left bare after September 30th, and the County is unsuccessful in contacting the Owner or his/her designated emergency contact person, the County may enter the project site and install temporary ground cover measures and bill the Owner for all expenses incurred by the County. These costs will be in addition to any monetary penalties levied against the Owner.

2. Delineation of clearing and easement limits. Clearing limits, setbacks, buffers, and sensitive or critical areas such as steep slopes, wetlands and riparian corridors shall be clearly marked in the field and inspected by Kitsap County Department of Community Development prior to commencement of land clearing activities.
3. Protection of adjacent properties. Adjacent properties shall be protected from sediment deposition by appropriate use of vegetative buffer strips, sediment barriers or filters, dikes or mulching, or by a combination of these measures and other appropriate BMPs.
4. Timing and stabilization of sediment trapping measures. Sediment ponds and traps, perimeter dikes, sediment barriers and other BMPs intended to trap sediment on-site shall be constructed as a first step in grading. These BMPs shall be functional before land disturbing activities take place. Earthen structures such as dams, dikes, and diversions shall be stabilized according to the timing indicated in item (1) above.
5. Slope Stabilization. Cut and fill slopes shall be constructed in a manner that will minimize erosion. Roughened soil surfaces are preferred to smooth surfaces. Interceptors should be constructed at the top of long, steep slopes which have significant areas above that contribute runoff. Concentrated runoff should not be allowed to flow down the face of a cut or fill slope unless contained within an adequate channel or pipe slope drain. Wherever a slope face crosses a water seepage plane, adequate drainage or other protection should be provided. In addition, slopes should be stabilized in accordance with item (1) above.
6. Controlling off-site erosion. Properties and waterways downstream from development sites shall be protected from erosion due to increases in the volume, velocity, and peak flow rate of stormwater runoff from the development site by the implementation of appropriate BMPs to minimize adverse downstream impacts.



7. **Stabilization of temporary conveyance channels and outlets.** All temporary on-site conveyance channels shall be designed, constructed and stabilized to prevent erosion from the expected flow velocity from a 2-year frequency, 24-hour duration storm for the post-development condition. Stabilization adequate to prevent erosion of outlets, adjacent streambanks, slopes and downstream reaches shall be provided at the outlets of all conveyance systems.
8. **Storm drain inlet protection.** All storm drain inlets made operable during construction shall be protected so that stormwater runoff shall not enter the conveyance system without first being filtered or otherwise treated to remove sediment. After proper written application, the requirement for inlet protection may be waived by the Director on a site-specific basis when the conveyance system downstream of the inlet discharges to an appropriate sediment containment BMP and the conveyance system can be adequately cleaned following site stabilization.
9. **Underground utility construction.** The construction of underground utility lines shall be limited, where feasible, to no more than 500 feet of open trench at any one time. Where consistent with safety and space considerations, excavated material shall be placed on the uphill side of the trench. Dewatering devices shall discharge to an appropriate sediment trap or pond, preceded by adequate energy dissipation, prior to runoff leaving the site.
10. **Constructed access routes.** Wherever construction vehicle access routes intersect paved roads, provisions must be made to minimize the transport of sediment (mud) onto the paved road by use of appropriate BMP's such as a Stabilized Construction Entrance. If sediment is transported onto a road surface, the roads shall be cleaned thoroughly, as a minimum, at the end of each day. Sediment shall be removed from roads by shoveling or sweeping and be transported to a controlled sediment disposal area. Street washing shall be allowed only after sediment is removed in this manner.
11. **Removal of temporary BMPs.** All temporary erosion and sediment control BMPs shall be removed within 30 days after final site stabilization is achieved or after the temporary BMPs are no longer needed. Trapped sediment shall be removed or stabilized on-site. Disturbed soil areas resulting from removal of temporary BMPs shall be permanently stabilized. The removal of temporary erosion and sediment control BMPs may not be required for those projects, such as single family plats, that will be followed by additional construction under a different permit. In these circumstances, the need for removing or retaining the measures will be evaluated on a site-specific basis.
12. **Dewatering construction sites.** Dewatering devices shall discharge into an appropriate sediment trap or pond, designed to accept such a discharge preceded by adequate energy dissipation, prior to runoff leaving the site.

13. Control of pollutants other than sediment on construction sites. All pollutants other than sediment that occur on-site during construction shall be handled and legally disposed of in a manner that does not cause contamination of storm or surface waters. Pollutants of concern include, but are not limited to, fuels, lubricants, solvents, concrete bi-products and construction materials
14. Maintenance. All temporary and permanent erosion and sediment control BMPs shall be maintained and repaired as needed to assure continued performance of their intended function. All maintenance and repair shall be conducted in accordance with the Manual. The Applicant shall be responsible for assuring that any such facilities damaged during floods, storms or other adverse weather conditions are immediately returned to normal operating condition.
15. Financial liability. A performance covenant or performance surety, shall be required for all projects to ensure compliance with the approved erosion and sediment control plan, as outlined in Section 4.0 of the Kitsap County Stormwater Ordinance.

### **3.2.5 EROSION AND SEDIMENTATION CONTROL PLAN**

The Ordinance requires that an Erosion and Sedimentation Control plan be submitted for review and approval prior to beginning site development activities.

Kitsap County staff will review the ESC plan to verify that a reasonable plan is being proposed to control erosion and sedimentation and, ultimately, to preserve the quality of the stormwater leaving the construction site.

A Site Development Activity Permit will not be issued until an ESC plan is approved which complies with the minimum requirements for erosion and sedimentation control and which represents a reasonable plan for the specific project site. Kitsap County will require that the plan be strictly adhered to as minimum requirements for erosion and sedimentation control. Erosion and sedimentation controls shall be maintained until the project site is permanently stabilized.

An Erosion and Sedimentation Control (ESC) plan must address the control of erosion and sedimentation continuously throughout construction and also following construction. The ESC plan may be a separate plan specifically addressing erosion and sedimentation control, or it can be a part of another construction plan. For all major developments, the ESC plan must also be prepared by and bear the seal of a qualified Professional Engineer.

At times it will be found that the approved erosion and sedimentation control facilities are not adequate. This may be because of unanticipated conditions that have arisen on the construction site, or because of damage resulting from storms, construction equipment, soil failures, etc. In order to maintain the quality of water leaving the project site under these circumstances, it may be necessary that the erosion and sedimentation control facilities be

modified. In circumstances where the erosion and sedimentation control facilities are to be modified, the following rule must be followed:

Except for emergency conditions or when changes are deemed by the Director to be of a minor nature, the Project Engineer must revise the ESC plan and submit it for approval to the County prior to any modifications being made on the project site.

It should be emphasized that, except for emergency conditions, the contractor may not deviate from the ESC plan and that only the Project Engineer (not the owner or contractor) is authorized to direct changes in the erosion and sedimentation control facilities.

For an ESC plan to be effective, it is essential that provisions for erosion and sedimentation control measures be made in the early planning stage of the project. The following basic planning principles should be applied to the maximum extent possible in order to control erosion/sedimentation during and after construction:

1. Fit the project to the terrain to minimize the amount of clearing and grading.
2. Time grading and construction to minimize soil exposure, particularly for highly erodible soils.
3. Retain existing vegetation whenever feasible.
4. Vegetate and mulch denuded areas.
5. Direct runoff away from denuded areas in a timely manner.
6. Minimize length and steepness of slopes.
7. Keep runoff velocities low.
  
8. Prepare drainage ways and outlets to handle concentrated or increased runoff and discharge in controlled manner.
9. Trap sediment on site.
10. Inspect and maintain control measures frequently.



**APPENDIX 3A**

**ESC BEST MANAGEMENT PRACTICES REFERENCE  
GUIDE**



## ESC BEST MANAGEMENT PRACTICES REFERENCE GUIDE

Impact:	Control Measure:	Page
<b>CONSTRUCTION VEHICLE TRAFFIC</b>		
Mud, dirt, rock transported onto roads from site having bare ground	<b>Stabilized Construction Entrance</b> (may be used with Filter Fabric Fence).	3B-2
Erosion of constructed roads following rough grading, caused by construction equipment.	<b>Construction Road Stabilization.</b>	3B-4
Surface and air movement of dust from exposed soil surfaces subjected to vehicle traffic.	<b>Dust Control</b> (may be used with Stabilized Construction Entrance).	3B-5
<b>BARE GROUND</b>		
Surface runoff over bare ground results in silt suspended in stormwater, causing turbidity.	<b>Limit Clearing of Site.</b>	3B-6
Water velocity and turbulence caused erosion.	<b>Rip Rap.</b>	3B-7
Sheetflow velocity causes erosion on small slope areas no steeper than 2:1.	<b>Straw/Hay Bale Barrier.</b>	3B-37
During extended rainy periods, bare ground is subject to erosion.	<b>Cover areas left unworked for more than 48 hours</b> (may use Mulching, Sodding or Plastic Sheeting).	3B-8

During extended rainy periods, bare ground is subject to erosion during short construction delays.

**Mulching** (often with Nets and Mats).

3B-9

Bare slopes steeper than 2:1, or with highly erodible soils, are subject to erosion.

**Nets and Mats.**

3B-11

Bare ground no steeper than 2:1 has topsoil removed or is too dense or impermeable to support vegetation growth.

**Topsoiling** (used in conjunction with Temporary or Permanent seeding).

3B-13

Bare ground sloping up to 10% for 100 ft or less, not subject to traffic, will not be ready for permanent cover treatment for 30 days to 1 year, and is subject to erosion.

**Temporary Erosion Control Seeding** (may be used with Topsoiling, Surface Roughening, Mulching, Plastic Sheeting and Nets and Mats).

3B-14

Bare ground, subject to erosion, is ready for permanent stabilization or will not be ready for permanent stabilization for 1 year or more.

**Permanent Seeding** (may be used with Topsoiling, Surface Roughening, Mulching, Plastic Sheeting and Nets and Mats).

3B-16

Bare ground being seeded for erosion control is subject to erosion from surface runoff velocity before vegetation becomes established.

**Surface Roughening** (may be used with Topsoiling, Temporary Erosion Control Seeding, Permanent Seeding, Mulching and Sodding).

3B-18

Bare ground is subject to erosion unless immediate vegetative cover is established and/or aesthetics is a factor. Also, waterways carrying intermittent flows are subject to erosion unless stabilized.

**Sodding** (may be used with Topsoiling).

3B-21



Bare ground, seed beds, or other areas are subject to erosion unless immediate erosion protection is provided, particularly during winter when seeding is not recommended, or when areas cannot be covered by mulching.

**Plastic Sheeting.**

3B-22

## **SEDIMENT IN STORMWATER**

Sediment-laden runoff from a small site having a tributary drainage area of less than 3 acres and where permanent stabilization is expected within 6 months.

**Sediment Trap.**

3B-23

Sediment-laden runoff from a site having a tributary drainage area of less than 10 acres and where permanent stabilization is not expected within 6 months.

**Sediment Pond.**

3B-25

Sediment-laden runoff discharges from site by sheet flow or from minor swale or ditch with maximum flow of 0.5 cfs.

**Filter Fabric Fence** (may also be used with Sediment Trap, Sediment Pond, Brush Barrier, or Inlet Barrier).

3B-29

Sediment-laden runoff sheet-flows from <1/4 acre tributary area of site, and residue brush is available.

**Brush Barrier** (may be used with Filter Fabric Fence).

3B-33

Sediment-laden runoff in cleared rights-of-way or other traffic areas.

**Gravel Filter Berm.**

3B-35

Small amounts of sediment migrate from bare disturbed slopes no steeper than 2:1.

**Straw/Hay Bale Barrier.**

3B-37

Sediment-laden runoff enters a storm drain inlet from a tributary area less than 1 acre that is flatter than 5% slope.	<b>Filter Fabric Fence Inlet Barrier</b> (using Filter Fabric Fence material).	3B-40
--	--	-------

Sediment-laden runoff enters a storm drain inlet from a large tributary area resulting in flows >0.5 cfs.	<b>Block and Gravel Filter Inlet Barrier.</b>	3B-42
---	---	-------

Sediment-laden runoff enters a storm drain inlet from a large tributary area resulting in flows >0.5 cfs, and construction traffic may occur over the inlet.	<b>Gravel and Wire Mesh Filter Inlet Barrier.</b>	3B-44
--	---	-------

**STEEP SLOPES**

Runoff flowing down face of steep slopes causes erosion and/or saturation of slide-prone soils.	<b>Pipe Slope Drains</b> (may be used with Interceptor Dike/Berm and Swale).	3B-46
---	--	-------

Volume and/or velocity of runoff flowing down face of disturbed slopes causes erosion.	<b>Interceptor Dike/Berm and Swale</b> (may be used with Pipe Slope Drains).	3B-48
--	--	-------

Site has relatively deep, permeable soils which are excessively wet, or there is seepage from face of slope.	<b>Subsurface Drains</b> (may be used with Filter Fabric, Fence Material, and in conjunction with a Sediment Trap or Sediment Pond).	3B-51
--	--	-------

Slopes are unstable due to seepage from the face of slopes and/or non-cohesive soils.	<b>Rip Rap</b>	3B-7
---	----------------	------

## STOCKPILES

Exposed, uncompacted earth stockpiles are constructed during winter months, or are otherwise prone to excessive erosion caused by surface runoff

**Cover and properly locate stockpiles** (may be used in conjunction with Topsoiling Plastic Sheeting, Mulching, Nets and Mats).

3B-53

## SHORELINES

Graded slopes, or the placement of earth at or near shorelines, may slough, slide or erode.

**Restrict placement of constructed slopes or earthworks** (may be used with Plastic Sheeting, or Nets and Mats).

3B-54

## STREAMS

Increased stream flow or disturbance during construction results in eroding section of stream bank.

**Structural Streambank Stabilization** (may be used with Rip Rap).

3B-55

Increased stream flows or disturbance during construction resulting in a potential for excessive erosion of stream banks.

**Vegetative Streambank Stabilization.**

3B-56

## OUTFALLS

Flow velocity at outlet of a channel or pipe could result in erosion of downstream or flooding at outlet.

**Outlet Protection** (may be used with Rip Rap).

3B-57

## NO DEFINED DOWNSTREAM

Runoff flow, which is relatively free of sediment, is concentrated on-site and can cause damage to downstream property if not converted to sheetflow.

**Level Spreader.**

3B-58

## **OFF-SITE DRAINAGE ENTERING SITE**

Runoff enters construction site, flowing through areas to be disturbed, increasing potential for erosion and sedimentation.

**Diversion Channels and Ditches.**

3B-60

## **SWALES, CHANNELS OR DITCHES**

Flow velocity in unvegetated swales, channels and ditches can cause erosion.

**Rip Rap.**

3B-7

Flow velocity in unvegetated swales, channels and ditches having a tributary area <10 acres can cause erosion, but rip rap armoring is not feasible.

**Check dams.**

3B-61

## **TRENCHES FOR UNDERGROUND UTILITIES**

Trenches excavated on down slope of >5% can convey stormwater at high velocity, resulting in erosion of trench bottom.

**Restrict the length of trench opened at any one time.**

3B-63

Surface water entering open trenches can cause erosion of trench walls and bottom.

**Divert surface runoff from entering trench (may also use Interceptor Dike/Berm and Swale).**

3B-64

Dewatering devices for trenches (or from other wet soil conditions) can, if discharged improperly, adversely impacted downstream properties and drainage facilities.

**Discharge dewatering devices properly (also see Sediment Trap).**

3B-65

**APPENDIX 3B**  
**ESC BEST MANAGEMENT PRACTICES**



---

---

**CONTROL MEASURE: STABILIZED CONSTRUCTION ENTRANCE.**

**Purpose:** Reduces the amount of debris transported onto public roads from construction equipment by action of vehicle tires traveling over gravel pad removing most mud and debris from tires.

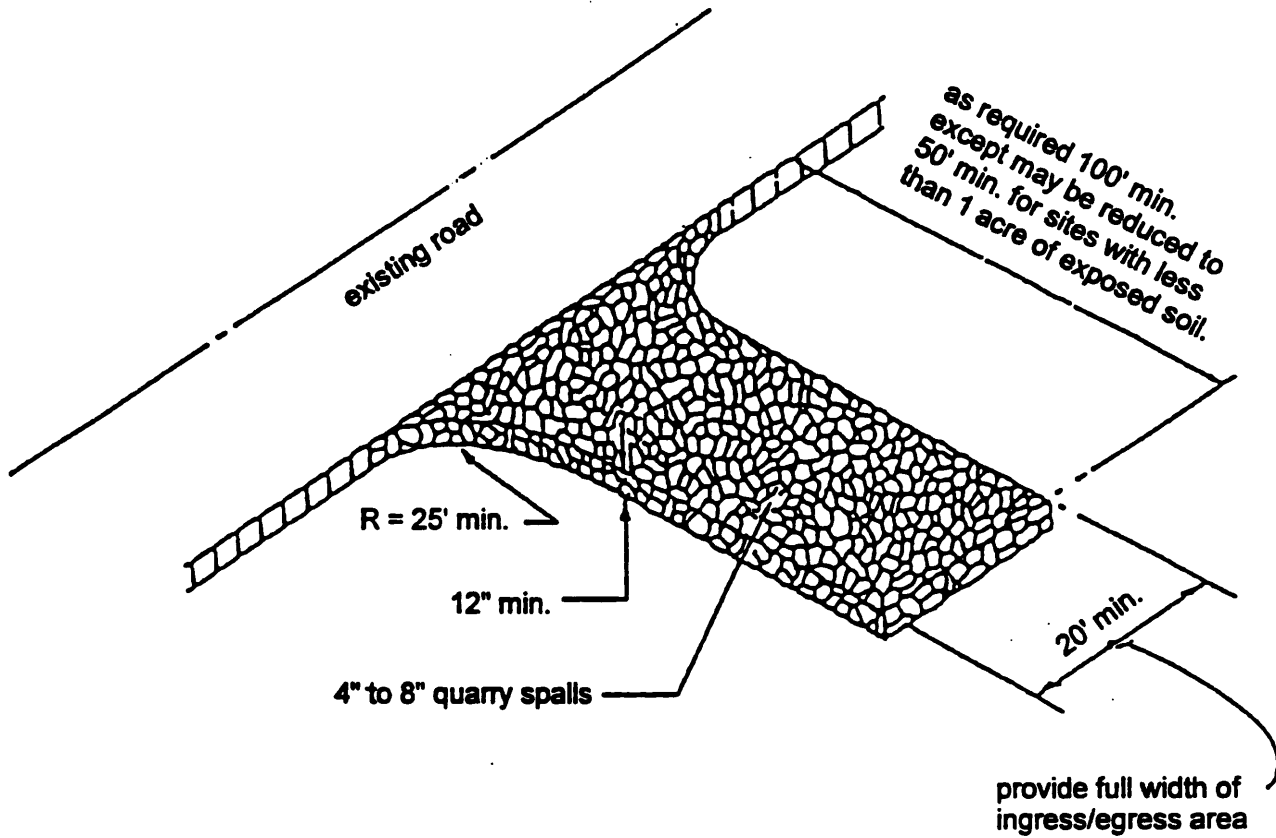
**Design Criteria/Specifications:**

**Design:** (1) See Figure 3-1 for detail, (2) **Stabilized Construction Entrances** should be located wherever vehicle access routes intersect paved roads; (3) Material should be quarry spalls, 4" - 8" size; (4) The rock pad should be at least 12-inches thick and 100-feet in length. Length may be reduced to 50-feet for sites with minor grading (less than 1 acre of exposed soil); (5) Width should be the full width of the vehicle ingress and egress area. Minimum width should be 20-feet. Additional subgrade stabilization such as a geotextile mat may be required.

**Procedures:** (1) A **filter fabric fence** should be installed downhill from the construction entrance to intercept and contain any sediment-laden runoff from the entrance or from tire washing; (2) If the rock pad does not adequately remove the mud from vehicle wheels, the wheels should be hosed off before the vehicle enters a paved street. The washing should be done on an area covered with crushed rock and wash water should drain to a sediment retention facility; (3) Street cleaning equipment should be available as required.

**Maintenance:** (1) Entrances may require periodic top dressing with 2-inch stone, as necessary to prevent tracking or flow of mud onto public roadways; (2) If sediment is transported onto a road surface, the roads **shall** be cleaned thoroughly as a minimum at the end of each day. Sediment should be removed from roads by shoveling or sweeping. Street washing should take place only after sediment has been removed as described above; (3) Any rock spalls that are loosened from the pad and end up on the roadway **shall** be removed immediately.

Figure 3-1 STABILIZED CONSTRUCTION ENTRANCE





---

---

**CONTROL MEASURE: CONSTRUCTION ROAD STABILIZATION.**

**Purpose:** Temporarily stabilizes roads, parking areas, and on-site transportation routes with stone immediately after grading, reduces erosion caused by construction traffic or runoff.

**Design Criteria/Specifications:**

**Design:** (1) Provide rock stabilization wherever there is the potential for erosion of temporary construction routes by construction traffic during wet weather; (2) Rock stabilization may be unnecessary where soils on site are gravelly; (3) A 6-inch depth of 2"-4" crushed rock, gravel base, or crushed surfacing base course shall be applied immediately after grading or the completion of utility installation within the right-of-way. A 4-inch course of asphalt treated base (ATB) may be used instead of the crushed rock.

**Procedures:** (1) Where feasible, alternative routes should be made for construction traffic; one for use in dry condition, the other for wet conditions which incorporates the measures listed below; (2) Temporary roads should follow the contour of the natural terrain to the extent possible. Slope should not exceed 15 percent. Roadways should be carefully graded to drain transversely. Provide drainage swales on each side of the roadway in the case of a crowned section, or one side in the case of a super elevated section. (3) Installed inlets shall be protected to prevent sediment laden runoff from entering the storm system. (See BMPs on **Filter Inlet Barriers**).

**Maintenance:** Inspect stabilized areas regularly, especially after large storm events. Add crushed rock if necessary and restabilize any areas found to be eroding.

---

---

**CONTROL MEASURE: DUST CONTROL.**

**Purpose:** Prevents surface and air movement of dust from exposed soil surfaces.

**Design Criteria/Specifications:** (1) Minimize the period of soil exposure through use of temporary ground cover and other temporary stabilization practices. (See **Bare Ground BMPs**). (2) Site should be sprinkled with water until surface is wet. Repeat as needed. To prevent carryout of mud onto street, refer to **Stabilized Construction Entrance BMP** in this section. (3) Spray exposed soil areas with an appropriate dust palliative. Note: oil is prohibited for use as a palliative.

---

---

**CONTROL MEASURE: LIMIT CLEARING OF SITE.**

**Purpose:** Reduces likelihood of, or extent of, turbidity in downstream stormwater by minimizing the source of silt picked up on surface runoff.

**Design Criteria/Specifications:** Clearing should be limited to the minimum area necessary to perform work and immediately revegetate cleared areas. When possible, construction should be planned in stages, and only the stage being worked on should be cleared. Once work is completed, a given stage of construction should be immediately revegetated or otherwise stabilized.

---

---

**CONTROL MEASURE: RIP RAP.**

**Purpose:** Slows the velocity of concentrated runoff. Also stabilizes slopes with seepage problems and/or non-cohesive soils by placement of large, loose, angular stone.

**Design Criteria/Specifications:** (1) See Table 7-4 in Chapter 7 for recommended stone sizes for a given flow velocity; (2) For durability, stability and economy, it is recommended that graded rather than uniform rip rap be utilized; (3) Since rip rap is used where erosion potential is high, construction should be sequenced so that the rip rap is put in place with the minimum possible delay. Disturbance of areas where rip rap is to be placed should be undertaken only when final preparation and placement of the rip rap can follow immediately behind the initial disturbance. Where rip rap is used for outlet protection, the rip rap should be placed before or in conjunction with the construction of the pipe or channel so that it is in place when the pipe or channel begins to operate.

**Maintenance:** Rip rap coverings should be inspected on a regular basis and after every large storm event.

---

---

**CONTROL MEASURE: COVER AREAS LEFT UNWORKED FOR MORE THAN 48 HOURS. (See also Mulching, Sodding, Plastic Sheeting BMPs).**

**Purpose:** Minimize the area exposed to rainfall and surface runoff, thereby reducing the amount of erosion of bare ground and the amount of sediment that might collect in sedimentation control structures, such as sediment ponds or silt fences.

**Design Criteria/Specifications:** During the time period of October 1 through April 30, and at other times of the year when there are extended periods of inclement weather, all project-disturbed soil areas that are to be left unworked for more than 48 hours should be covered by mulch, sodding, or plastic covering. This procedure is based on the increased potential for, and consequences of, failure of erosion and sedimentation control structures during this period of high precipitation and the assumption that areas not being worked are likely to be left unattended.

---

---

**CONTROL MEASURE: MULCHING.** (See also **Nets and Mats**).

**Purpose:** Mulching provides immediate temporary protection to exposed areas and allows germination and protection of seeded areas by conserving moisture, moderating soil temperatures, and holding fertilizer, seed and topsoil in place.

**Design Criteria/Specifications:**

**Design:** (1) Prepare soil as for seeding; (2) For application rates and specifications, see Table 3-1; (3) **Nets and Mats** used in conjunction with mulch should be used on slopes steeper than 2:1; (4) Wood fiber cellulose blankets are considered protective mulches and can be used alone on erodible soils and during all times of the year.

**Materials:** (1) Hay or Straw: Use straw where mulch effect is to be maintained for more than 3 months. Hay and straw are subject to wind blowing unless kept moist or tied down. They are the most common and widely used mulching material; good for erosion control in critical areas. Anchor by crimping, discing, rolling or punching into soil, covering with netting, spraying with a chemical or fiber binder or by keeping moist; (2) Wood fiber cellulose (partly-digested wood fibers): When used for erosion control on critical areas, the application rate should be doubled. Apply with hydromulcher. No tie down is required. Packaged in 100-lb. bags. Not recommended for highly erodible soils in hot weather; (3) Gravel, Crushed Stone or Slag: Excellent mulch for short slope and around woody plants and ornamentals. Use where subject to foot traffic; (4) Corn Stalks: shredded into 4 - 6" lengths, decomposes slowly and resists windblow; (5) Wood Chips: Cannot be closely mowed. Decompose slowly and do not require tacking. Does not provide nitrogen to seeds unless treated. Tends to wash down slopes steeper than 6%; (6) Bark Chips/Shredded Bark: Cannot be closely mowed. Additional nitrogen for seeds not required. Tends to wash down slopes steeper than 6%. Avoid tilling bark or sawdust into soil, as it tends to remove nitrogen from soil, releasing it only when it decays.

**Procedures:** (1) Mulches should be used following temporary or permanent seeding; (2) Mulching should immediately follow seeding in areas with slopes steeper than 2:1; (3) Mulches should be used in cleared areas that cannot be seeded because of the season; (4) Mulches should be used on exposed soils (including **Stockpiles** which are not final graded within 15 days) unless covered with **Plastic Sheeting**.

**Maintenance:** Mulched areas should be checked periodically, especially following severe storms, when damaged areas of mulch or tie-down material should be repaired.

**Table 3-1 MULCH MATERIAL, APPLICATION RATES AND SPECIFICATIONS**

<u>Mulch Material</u>	<u>Quality Standards</u>	<u>Application Rates per 1000 sq ft</u>	<u>Application Rates per Acre</u>	<u>Depth of Application</u>
Gravel, Crushed Stone or Slag	Washed: 3/4" - 1-1/2" size	9 cu. yds.	400 cu. yds.	3"
Hay or Straw	Air-dried; free from undesirable seed & coarse material	75-100 lbs., 2-3 bales	1.5-2.5 tons (90-120 bales)	Lightly cover entire surface (min. 2")
Wood Fiber Cellulose	Dyed green. No growth organism inhibiting factors	25-30 lbs.	1000-1500 lbs.	2"

---

---

**CONTROL MEASURE: NETS AND MATS. (See also Mulching).**

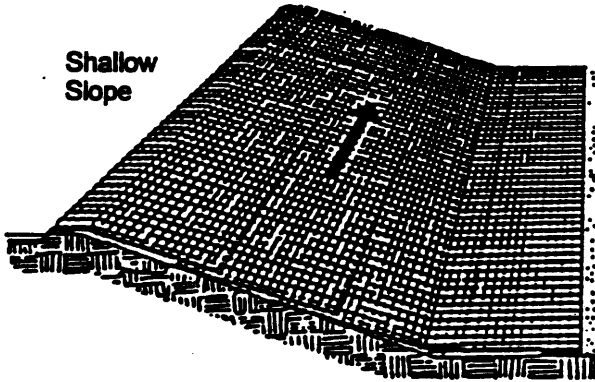
**Purpose:** To provide immediate temporary protection of exposed steep slopes and highly erodible soils. Also to provide temporary protection of waterway slopes.

**Design Criteria/Specifications:** (1) See Figure 3-2 for design features; (2) Nets and mats used alone, without **mulch**, do not retain soil moisture or modify soil temperature; (3) It is critical during installation to obtain firm, continuous contact between the net/mat material and the soil. Without such contact, the material is useless and erosion occurs; (4) When anchoring material, it is important to use an adequate number of staples and to roll the material after laying it to ensure that the soil is protected. Netting should be securely anchored to the soil with No. 11 gauge wire staples at least 6-inches long, with an overlap of 3- inches; (5) Site preparation is the same as for **temporary seeding**; (6) Where soil is highly erodible, nets should only be used in conjunction with organic **mulch**; (7) Jute nets should be heavy, uniform cloth woven of single jute yarn, which, if 36- to 48-inches wide, shall weigh an average of 1.2 lbs. per linear yard. Jute matting must be applied so that it is in complete contact with the soil, otherwise erosion will occur beneath it; (8) Wood fiber cellulose blankets are considered protective **mulches** and may be used alone on erodible soils and during all times of the year.



### Orientation of Netting and Matting

Shallow Slope

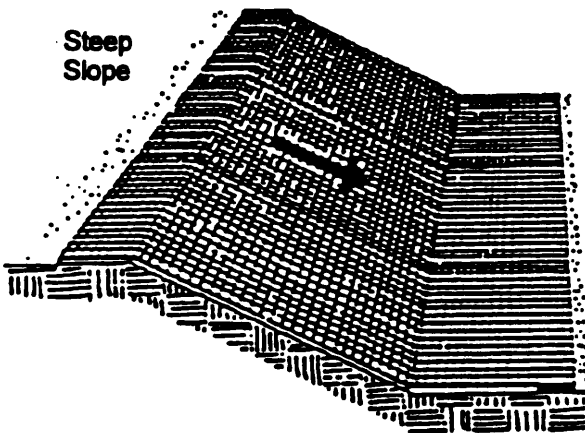


On shallow slopes, strips of netting may be applied across the slope. (Slopes up to 1:1)

Where there is a berm at the top of the slope, bring the netting over the berm and anchor it behind the berm.

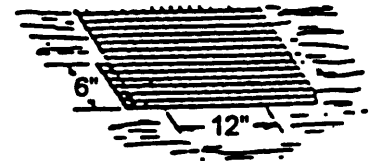


Steep Slope

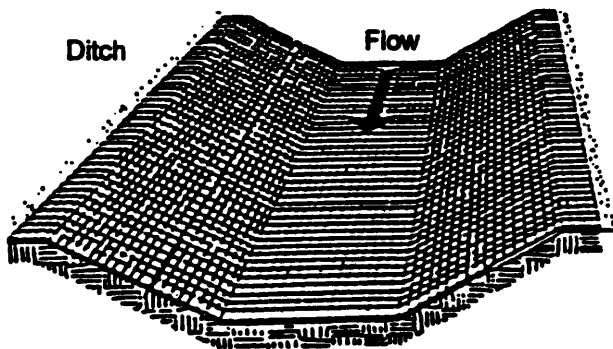


On steep slopes, apply strips of netting parallel to the direction of flow and anchor securely. (Slopes greater than 1:1)

Bring netting down to a level area before terminating the installation. Turn the end under 6" and staple at 12" intervals.



Ditch



In ditches, apply netting parallel to the direction of flow. Use check slots every 15 feet. Do not join strips in the center of the ditch.

---

---

**CONTROL MEASURE: TOPSOILING (See also Temporary Erosion Control Seeding and Permanent Seeding).**

**Purpose:** Provides a suitable growth medium for final site stabilization with vegetation.

**Design Criteria/Specifications:** (1) Stripping of existing topsoil should be confined to the immediate construction area, and all surface runoff control structures should be in place prior to stripping; (2) Topsoil should not be placed while in a frozen or muddy condition, or when the subgrade is excessively wet; (3) Topsoil should be spread at a compacted depth of 2 - 6-inches. More topsoil is needed if the subsoil is rocky; (4) Sufficient time should be allowed in scheduling for topsoil to be spread and bonded to subsoil prior to seeding, sodding or planting; (5) Care must be taken not to apply topsoil to subsoil if the two soils have contrasting textures. Sandy topsoil over clayey subsoil is a particularly poor combination, as water creeps along the junction between the soil layers and causes the topsoil to slough.

---

---

**CONTROL MEASURE: TEMPORARY EROSION CONTROL SEEDING. (See also Topsoiling, Surface Roughening, Mulching, Plastic Sheeting and Nets and Mats).**

**Purpose:** Reduces erosion and sedimentation by temporarily stabilizing exposed soils for up to 1 year.

**Design Criteria/Specifications:** (1) Seeding can be done during the period of March 1 through September 30 (if planted between May 15 and August 15 irrigation may be required). Seeding can sometimes also be done successfully during the remainder of the year, October 1 through February 29, provided that the seed bed is immediately stabilized by **mulching, nets/mats or plastic sheeting**; (2) Site preparation, including the installation of surface runoff control measures, should be completed prior to seeding. The seed bed should be firm but not compact, with a fairly fine surface. Surface roughening should be done at right angles to the slope and preferably "track walked" up slope. "Track-walking" is driving a crawler tractor up and down the slope, leaving a pattern of cleat imprints parallel to slope contours; (3) "Hydroseeding" applications with approved seed-mulch-fertilizer mixtures may also be used; (4) Soil amendments/fertilizers should be applied as recommended by suppliers. When seeding over subsoil (without **topsoil**), avoid over-fertilizing, especially near aquatic features. Instead, use **mulch** to assist in nourishing soil. Project sites adjacent to bodies of water must use nonphosphorus fertilizer; (5) Apply an appropriate seed mixture to the prepared seedbed at a rate of 120 lbs. per acre. Table 3-2 gives recommended **temporary erosion control seed mixture**.

**Maintenance:** (1) Inspect seeded areas for failure and make necessary repairs and reseed immediately; (2) Seed should be supplied with adequate moisture. Supply water as needed, especially in abnormally hot or dry weather, or on adverse sites. Water application rates should be controlled to prevent runoff. Insufficient amounts of water may be more harmful than no water.

Table 3-2 TEMPORARY EROSION CONTROL SEED MIXTURE

Name	Proportions By Weight	Percent Purity	Percent Germination
Redtop ( <u>Agrostis albe</u> )	10%	92%	90%
Annual Rye ( <u>Lolium multiflorum</u> )	40%	98%	90%
Chewings Fescue ( <u>Festuca rebra commutata</u> ) (Jamestown, Banner, Shaddow or Koket)	40%	97%	80%
White Dutch Clover ( <u>Trifolium</u> )	10%	96%	90%

\* Apply at a rate of 120 lbs./acre.

---

---

**CONTROL MEASURE: PERMANENT EROSION CONTROL SEEDING.** (See also **Topsoiling, Surface Roughening, Mulching, Plastic Sheeting, Nets and Mats**).

**Purpose:** Establishes a permanent protective layer of vegetation as fast as possible to prevent soil erosion by wind or water, and to improve wildlife habitat and site aesthetics.

**Design Criteria/Specifications:** (1) Seeding should be done immediately after final shaping if completed during the period of March 1 through September 30 (if planted between May 15 and August 15, irrigation may be required). Sites which cannot be seeded during this time period should be protected until the next seeding period with **Mulching**; (2) Site preparation should include **Topsoiling** and the installation of surface runoff control measures. The seedbed should be firm with a fairly fine surface; (3) If construction fills have left proposed seedbed with a loose, rough, or irregular surface, surface should be "track walked" up the slope or smoothed with a blade and rolled prior to planting. "Track-walking" is driving a crawler tractor up and down the slope, leaving a pattern of cleat imprints parallel to slope contours; (4) If proposed seedbed has tightly compacted surface, break with chisel plow or other suitable implement; (5) Soil amendments/fertilizers should be applied as recommended by suppliers. Project sites adjacent to bodies of water must use nonphosphorus fertilizer; (6) Apply an appropriate seed mixture to the prepared seed bed at a rate of 120 lbs. per acre. Table 3-3 gives recommended seed applications.

**Maintenance:** (1) Inspect seeded areas for failure and make necessary repairs and reseed immediately. Conduct a follow-up survey after one year and replace failed plantings where necessary; (2) If a stand has less than 40% cover, re-evaluate choice of plant materials and quantities of lime and fertilizer. Re-establish the stand following seedbed preparation and seeding recommendations, omitting lime and fertilizer in the absence of soil test results. If the season prevents re-sowing of seed, **Mulch, Nets/Mats or Plastic Sheeting** is an effective temporary cover.

Table 3-3 PERMANENT EROSION CONTROL SEEDING MIXTURE

Name	Proportions By Weight	Percent Purity	Percent Germination
<u>Urban Application:</u> Kentucky Bluegrass (Adelphi, Baron or Fylking)	30%	85%	80%
Creeping Red Fescue (Pennant)	40%	98%	90%
Perennial Rye (Derby, Pennant)	30%	95%	90%
<u>Rural Application:</u> Kentucky Bluegrass ( <u>Poa pratensis</u> ) (Birka, Majestic or Sydsport)	15%	85%	80%
Tall Fescue ( <u>Festuca arundinacea</u> ) (Arid, Jaguar or Rebel)	40%	95%	90%
Perennial Rye ( <u>Lolium perenne</u> ) (Derby or Pennant)	30%	95%	90%
Chewings Fescue (Banner)	15%	95%	90%

\* Apply at a rate of 120 lbs/acre. Cover seed with **topsoil** or **mulch** no deeper than ½-inch.

---

---

**CONTROL MEASURE: SURFACE ROUGHENING.** (See also **Erosion Control Seeding, Mulching, Topsoiling, Permanent Seeding, Sodding**).

**Purpose:** Aids in the establishment of vegetative cover and increases infiltration.

**Design Criteria/Specifications:** (1) Surface Roughening is intended to aid in the establishment of vegetative cover, which in turn is intended to protect the face of the slope from rainfall impact and sheetflow, bind the surface of the slope to retard erosion, and reduce the velocity of surface runoff. Surface roughening is not intended to accomplish any of the above by itself, and definitely should not be used to directly reduce the velocity of surface runoff; (2) Graded slopes steeper than 3:1 but less than 2:1 should be roughened before **seeding**. This can be accomplished in a variety of ways, including "track-walking", or driving a crawler tractor up and down the slope, leaving a pattern of cleat imprints parallel to slope contours. The tread imprints are ideal places to trap seeds and encourage plants to become established; (3) Graded areas steeper than 2:1 should be stair-stepped with benches. The stair-stepping will help vegetation become established and also trap soil eroded from the slopes above; (4) See Figure 3-3 and Figure 3-4 for detail.

Figure 3-3 SURFACE ROUGHENING TECHNIQUES

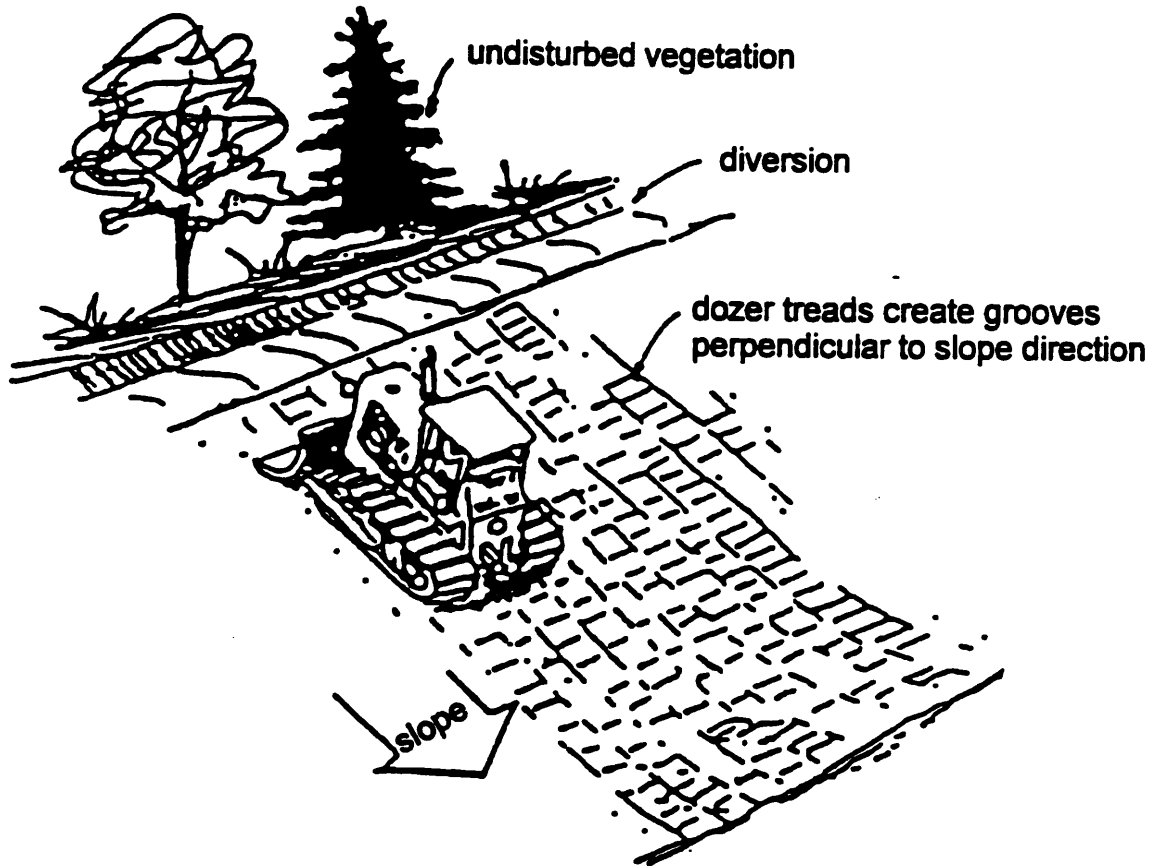
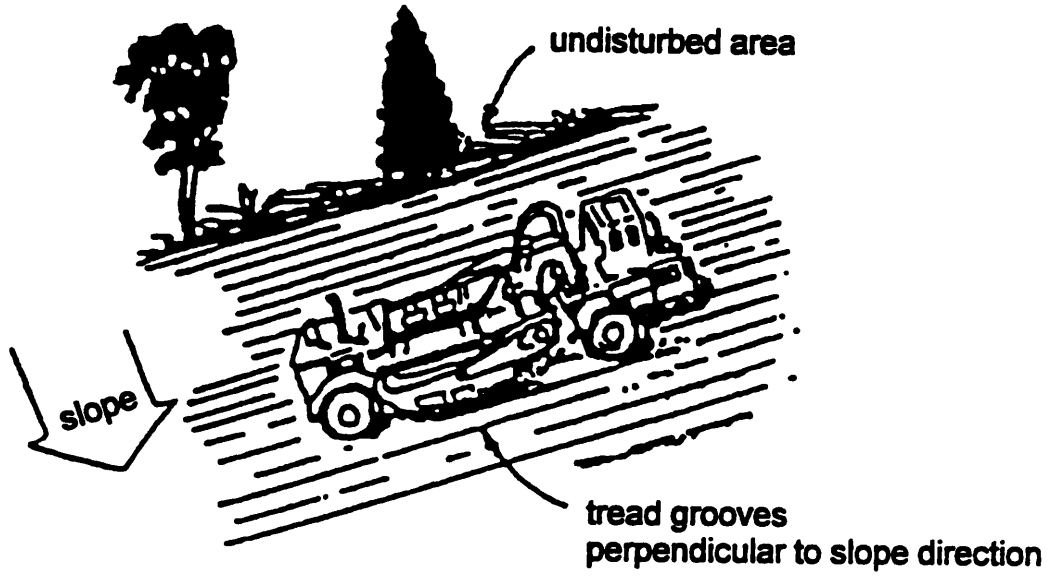
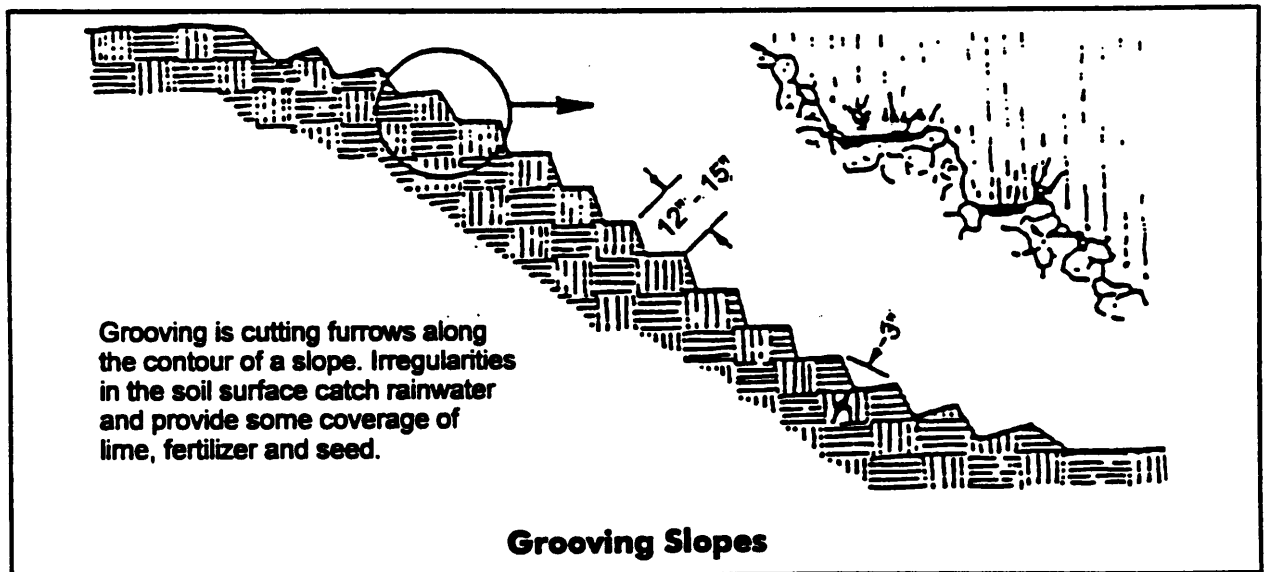
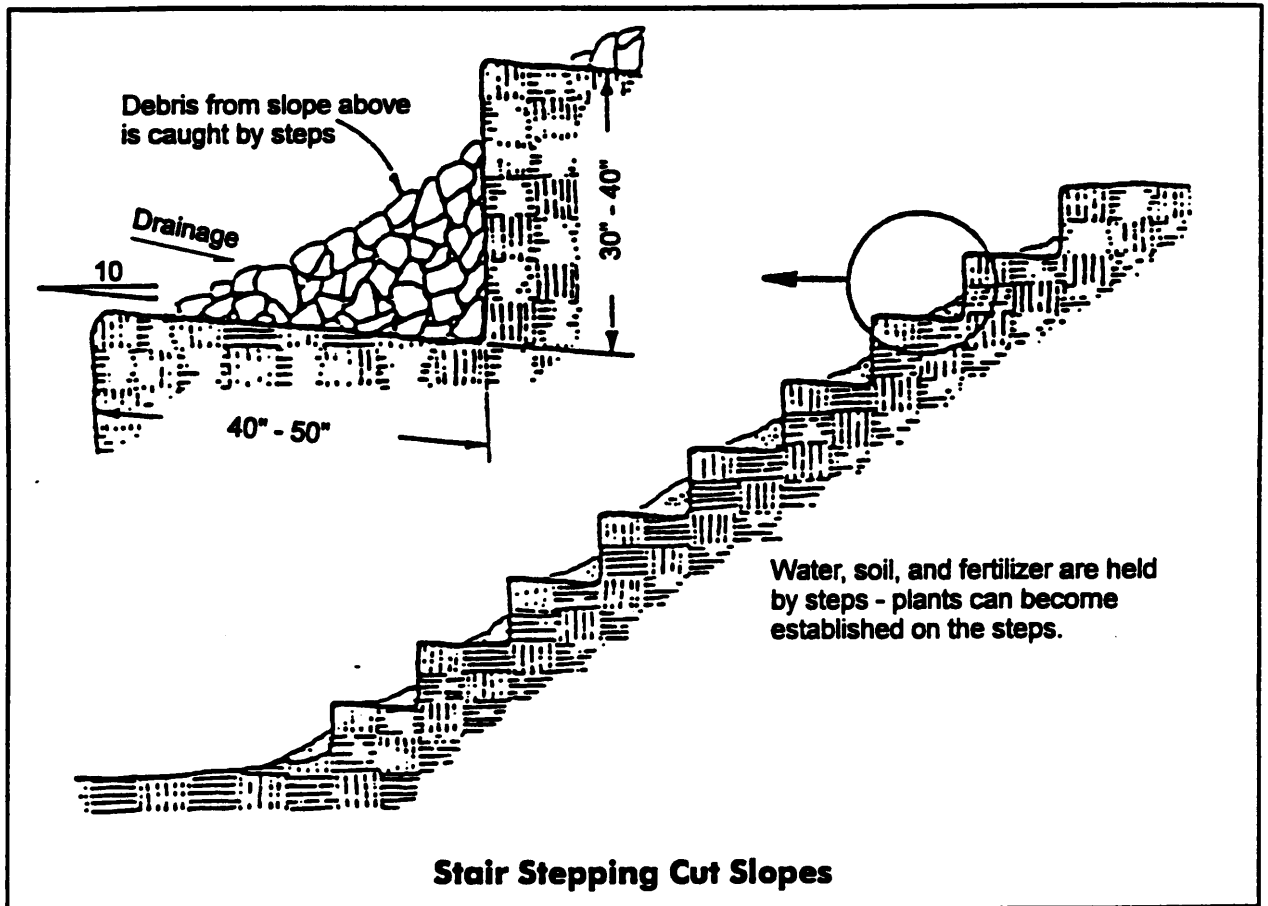




Figure 3-4 STAIR-STEPPING CUT SLOPES AND GROOVING SLOPES



---

---

**CONTROL MEASURE: SODDING.** (See also Topsoiling BMP).

**Purpose:** Establishes permanent turf for immediate erosion protection. Also stabilizes drainage ways where concentrated overland flow will occur.

**Design Criteria/Specifications:** (1) Shape and smooth the surface to final grade; (2) Apply topsoil as per this section; (3) Lime should be added to reach a soil Ph value of 6.5 (based on soil tests); (4) Soil amendments/fertilizers should be applied as recommended by suppliers. Project sites adjacent to bodies of water must use non-phosphorus fertilizer. It is recommended that fertilizers used not be highly soluble; (5) Lime and fertilizer should be worked into the soil 1 to 2-inches deep and the surface smoothed; (6) Sod should be harvested, delivered and installed within a period of 36 hours. It should not be harvested or transplanted when moisture content (excessively dry or wet) may adversely affect its survival; (7) Lay strips of sod beginning at the lowest area to be sodded and perpendicular to the direction of water flow. Wedge strips securely in place. Square the ends of each strip to provide for a close, tight fit. Stagger joints at least 12-inches. Staple if on steep slopes. Roll the sodded area and irrigate; (8) When sodding is carried out in alternating strips, or other patterns, seed the areas between the sod immediately after sodding; (9) Sod should be free of weeds and be of uniform thickness (approx. 1-inch) and should have a dense root mat for mechanical strength.

**Maintenance:** Sodded areas should be inspected regularly, especially after large storm events. Re-tack, re-sod, or re-seed as necessary.

---

---

**CONTROL MEASURE: PLASTIC SHEETING.**

**Purpose:** Provides immediate temporary erosion protection to slopes and disturbed areas that cannot be covered by **Mulching**. Also, protects disturbed areas which require covering during periods of inactivity in winter months. Plastic sheeting is the preferred covering for seedbeds planted during winter months, in that it not only protects against heavy rains but also provides warmth and light to promote germination and growth of seeds.

**Design Criteria/Specifications:** (1) Plastic sheeting should have a minimum thickness of 6 mil and meet the requirements of WSDOT/APWA Section 9-14.5; (2) Covering should be installed and maintained tightly in place by using sandbags or tires on ropes with a maximum 10 foot grid spacing in all directions. All seams shall be taped or weighted down full length and there should be at least a 12 - 24-inch overlap of all seams. Seams should then be rolled and staked or tied; (3) Covering should be installed immediately on areas seeded during winter months, and removed as soon as possible once vegetation is well grown to prevent burning the vegetation through the plastic sheeting, which acts as a greenhouse; (4) When covering is used on unseeded slopes, it should be left in place until the next seeding period; (5) Plastic covering sheets should be buried two feet at the top of slopes in order to prevent surface water flow beneath sheets

**Maintenance:** Plastic covering must be checked often for rips and places where the plastic may be dislodged. Contact between the plastic and the ground should always be maintained. Any air bubbles found should be removed immediately or the plastic may rip during the next windy period. Re-anchor or replace as necessary.

---

---

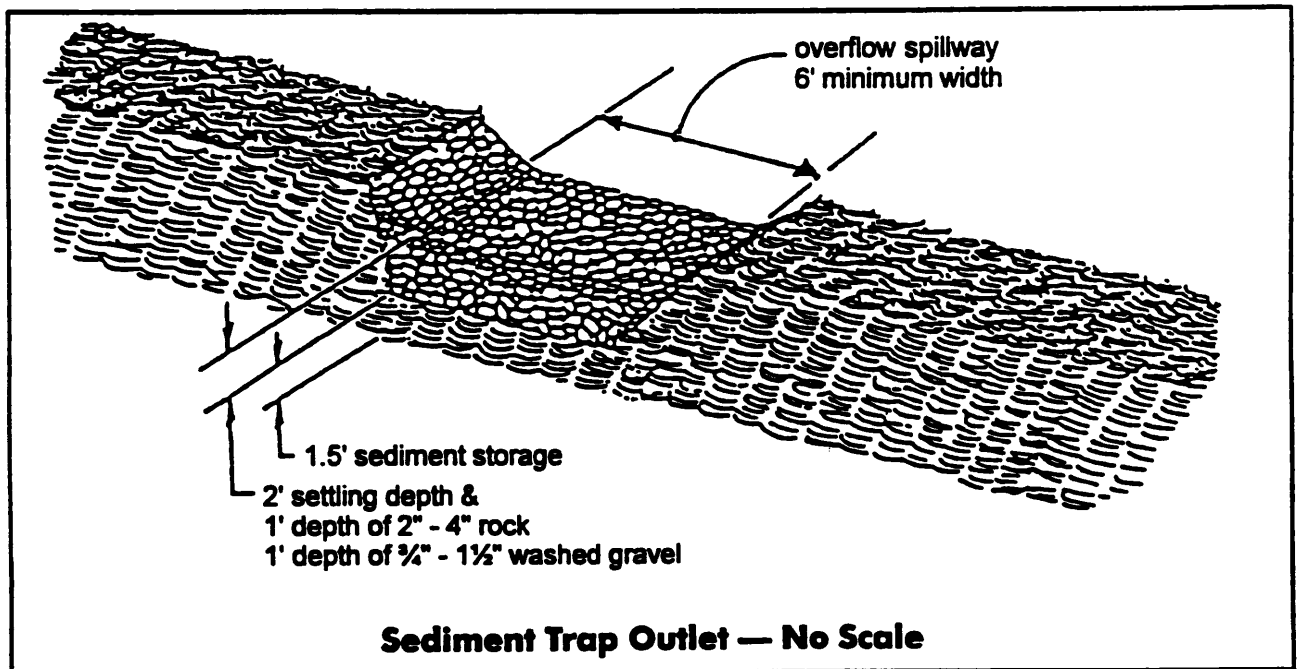
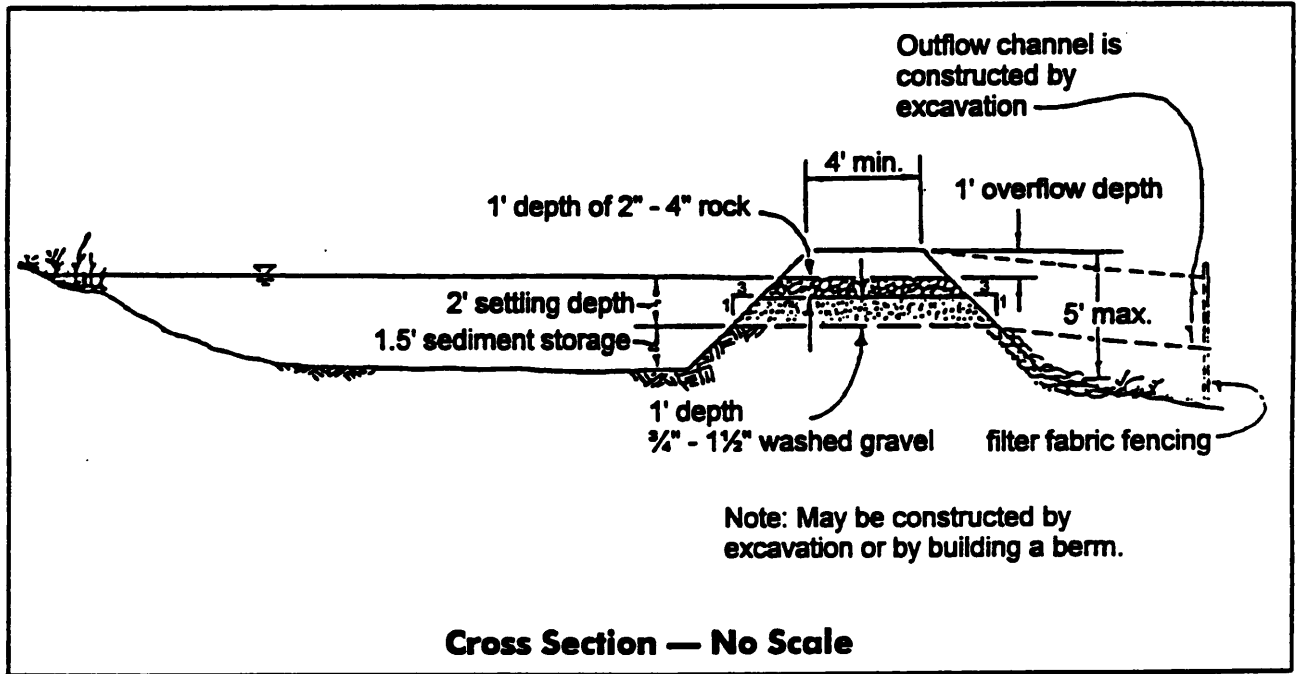
**CONTROL MEASURE: SEDIMENT TRAP.**

**Purpose:** Collects and stores sediment from a site cleared and/or graded during construction. It is intended for use on relatively small building areas with no unusual drainage features, and for projects with anticipated short "build-out" time (approximately 6 months or less). It is a temporary measure with a design life of less than 1 year. **Sediment traps** do not remove fine silt and clay suspended in stormwater.

**Design Criteria/Specifications:** (1) **Sediment traps** are recommended on relatively small building sites where the tributary drainage area is less than 3 acres; (2) See Figure 3-5 and 3-6 for design features; (3) **Sediment traps** may be formed completely by excavation or by construction of a compacted embankment. It should have a 1.5 foot deep sump for sediment storage. The outlet should be a weir/spillway section, with the lower 2 feet acting as a filter for sediment and the upper foot as the overflow spillway depth. A **filter fabric fence** should be provided to filter the runoff from the trap prior to discharge from the site; (4) The trap bottom should be level, with 3:1 side slopes. A 3:1 ratio between the trap length and width is desirable. Length is defined as the average distance from the inlet to the outlet of the trap; (5) The **sediment trap** should be sized to provide sufficient volume for sediment storage (assuming a storage depth of 1.5 feet) PLUS an additional 2 feet of storage depth for settling. The sediment volume shall be calculated by the engineer, based on currently established practices, such as contained in the D.O.E. Stormwater Management Manual for the Puget Sound Basin; (6) Retention ponds shall not be used for temporary sediment and erosion control, unless approved by the Director. In the event that a retention pond is approved for use as a **sediment trap**, the trap must be left at least 2 feet above the future finished grade for the retention pond and the trap must be completely lined with filter fabric or other device to prevent the migration of sediment to the plane of infiltration.

**Maintenance:** Sediment traps must be maintained until the site area is permanently protected against erosion by vegetation and runoff from impervious surfaces is directed to permanent drainage facilities. The key to having a functional sediment trap is continual monitoring and regular maintenance. The size of the trap is less important to its effectiveness than is regular sediment removal. Sediment should be removed from the trap when it reaches one half (1/2) of the designed maximum sediment storage depth. Regular inspections should be done and additional inspections made after each large runoff-producing storm event.

Figure 3-5 SEDIMENT TRAP



---

---

**CONTROL MEASURE: SEDIMENT POND.**

**Purpose:** Collects and stores sediment from sites cleared and/or graded during construction prior to establishment of permanent vegetation and/or construction of permanent drainage facilities. A sediment pond is usually a temporary structure having a design life of less than 1 year. However, it may be a more permanent facility, especially if required to provide runoff quality control until the site area is permanently stabilized.

**Design Criteria/Specifications:** (1) **Sediment ponds** are recommended on building sites where the tributary drainage area is less than 10 acres; (2) See Figure 3-6, 3-7, and 3-8 for design features; (3) **Sediment ponds** may be formed by excavation or by construction of a compacted embankment. It may have one or more inflow points carrying sediment-laden runoff. Baffles to spread the flow throughout the basin should be included. A securely anchored riser pipe is the principal discharge mechanism along with an emergency overflow spillway. The riser pipe should be solid with two 1-inch diameter dewatering holes located at the top of the sediment storage volume on opposite sides of the riser pipe. Outlet protection is provided to reduce erosion at the pipe outlet. A **filter fabric fence** should be provided to filter the runoff from the pond prior to discharge from the site; (4) **Sediment ponds** should have a maximum 3 foot deep sump for sediment storage; (5) The pond bottom should be level, with 3:1 side slopes; (6) The **sediment pond** should be sized to provide sufficient volume for sediment storage **PLUS** an additional 2 feet of depth for settling. Settling depth and sediment volume storage depth shall be calculated by an engineer (see the D.O.E. Stormwater Management Manual for the Puget Sound Basin). (7) Retention ponds shall not be used for temporary sediment and erosion control, unless approved by the Director, in that the collection of sediment in such a pond may later reduce its effectiveness as a retention device. In the event that a retention pond is approved for use as a **sediment pond**, the pond must be left at least 2 feet above the future finished grade for the retention pond and the pond must be completely lined with filter fabric or other device to prevent the migration of sediment to the plane of infiltration.

**Maintenance:** **Sediment ponds** must be maintained until the site area is permanently protected against erosion by vegetation, and until runoff from impervious surfaces is directed to permanent drainage facilities. The key to having a functional **sediment pond** is continual monitoring and regular maintenance. The size of the pond is less important to its effectiveness than is regular sediment removal. Sediment should be removed from the pond when it reaches approximately ½ of the total designed sediment storage depth. Regular inspections should be done and additional inspections made after each large runoff-producing storm event.

Figure 3-6 ESC STRUCTURAL PRACTICES

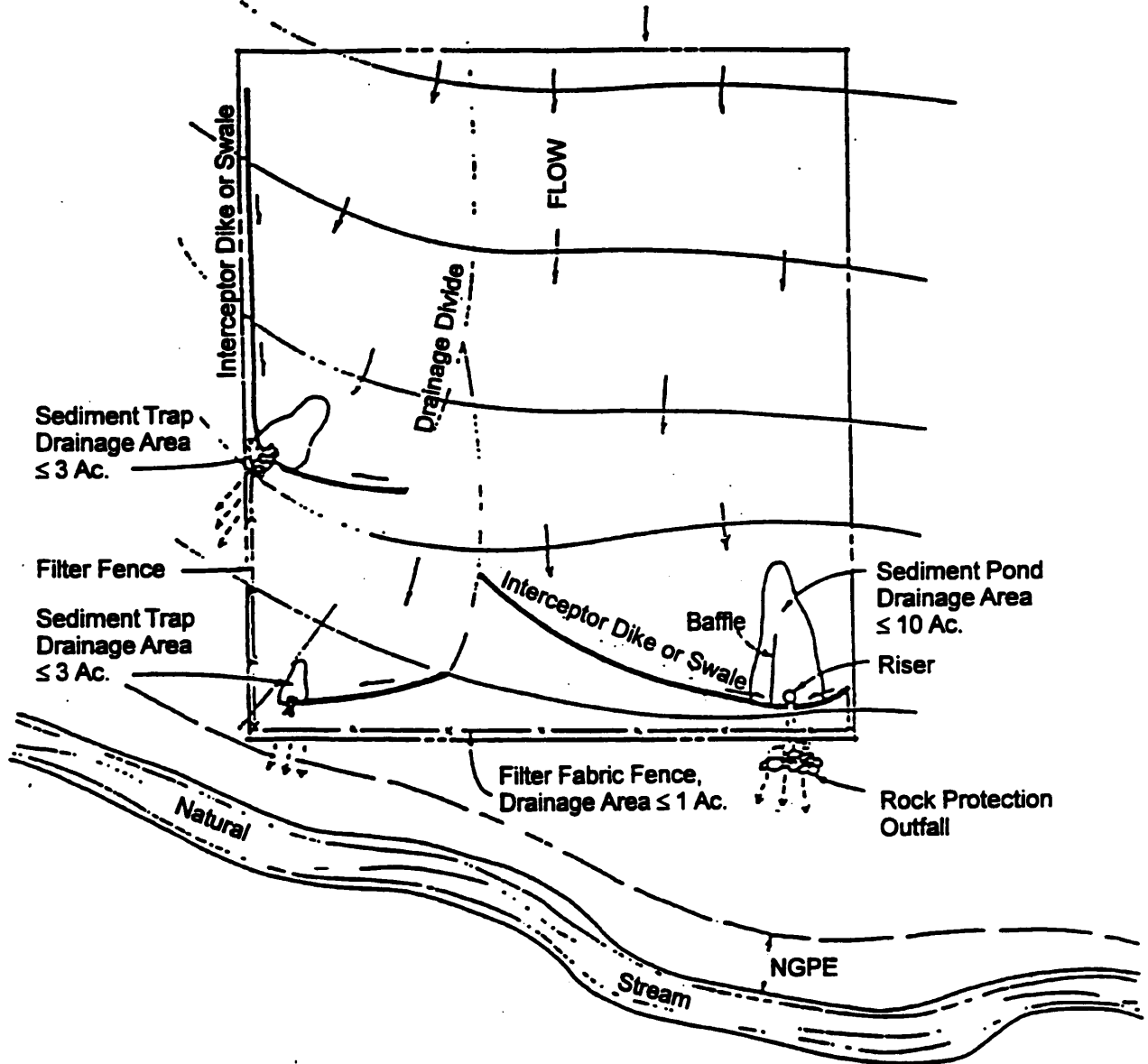


Figure 3-7 SEDIMENT POND

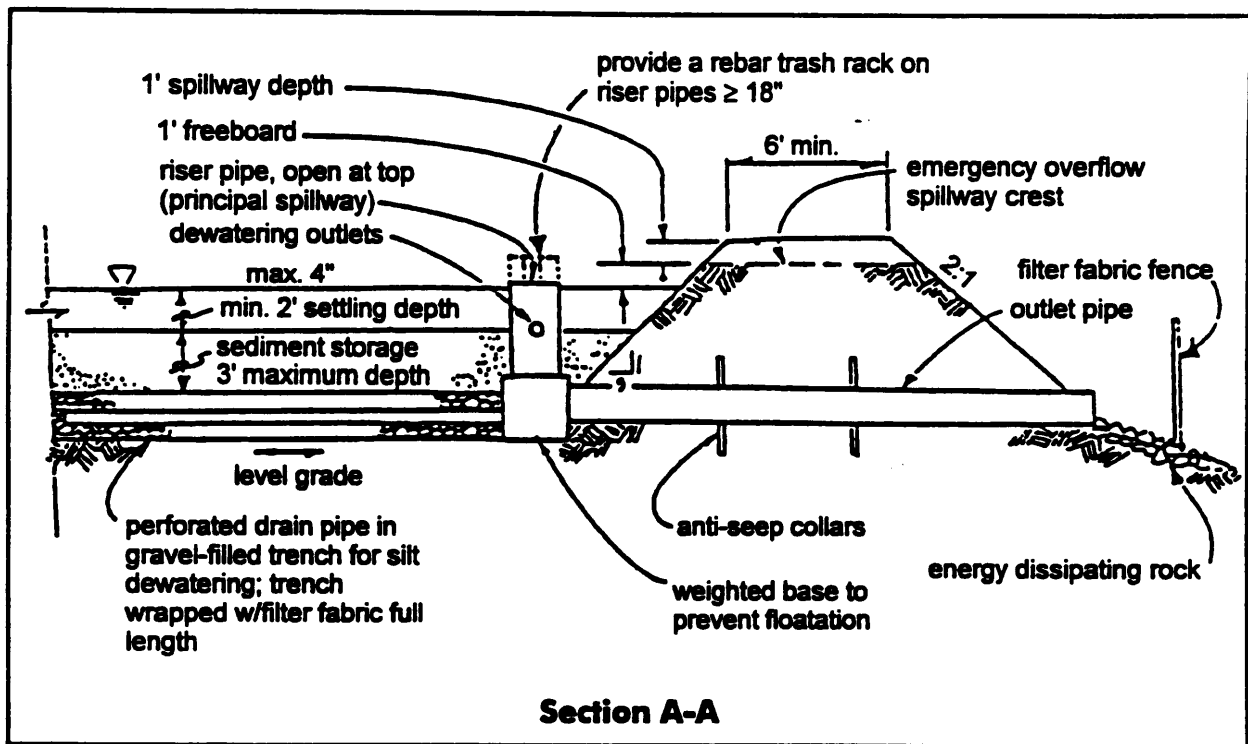
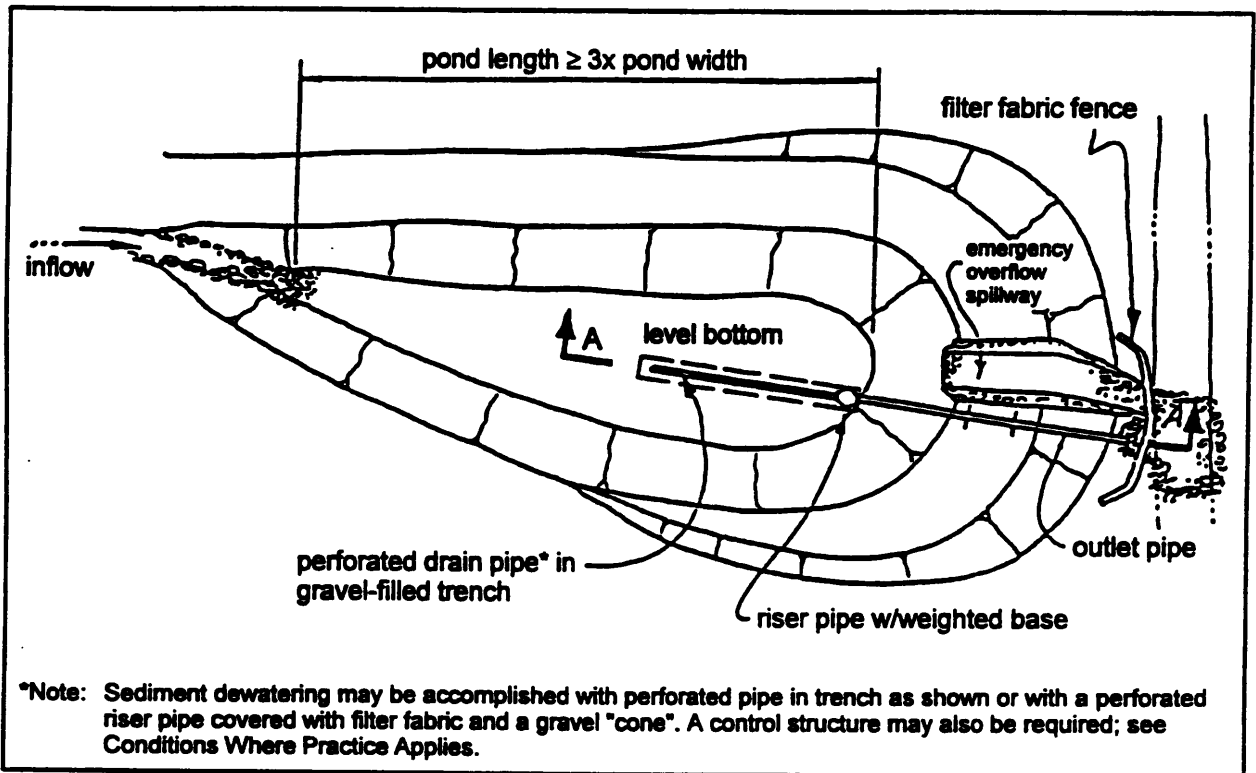
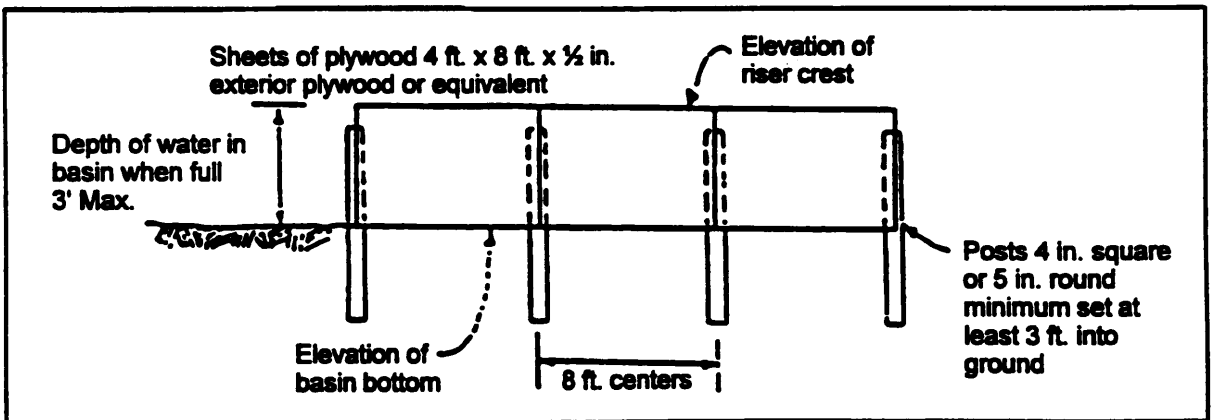
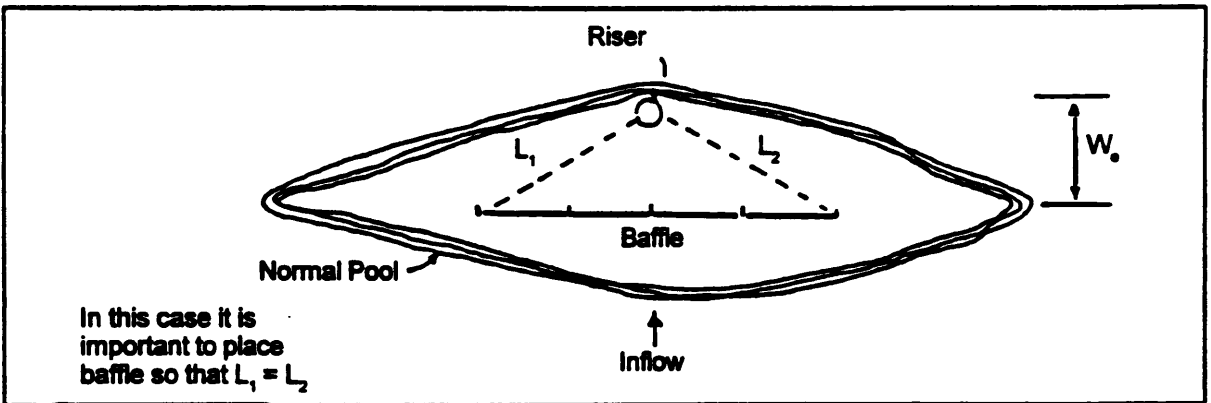
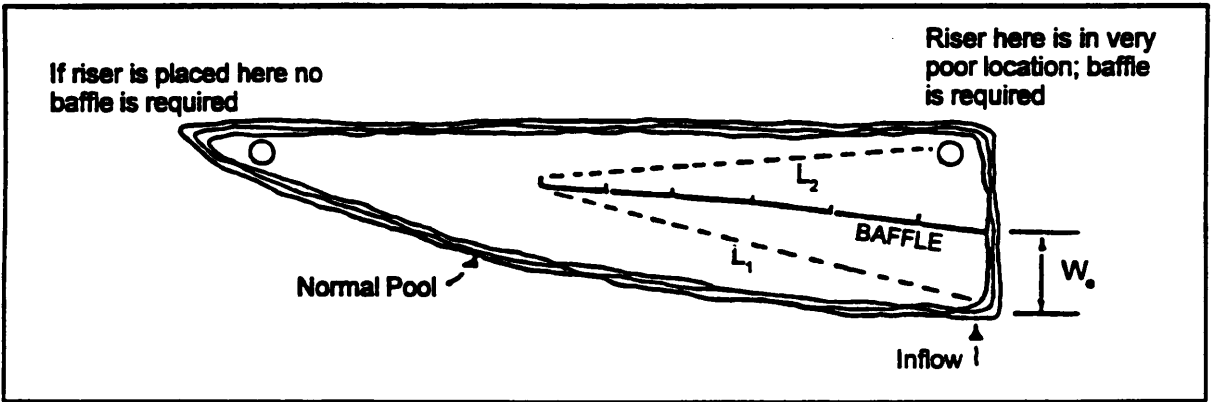
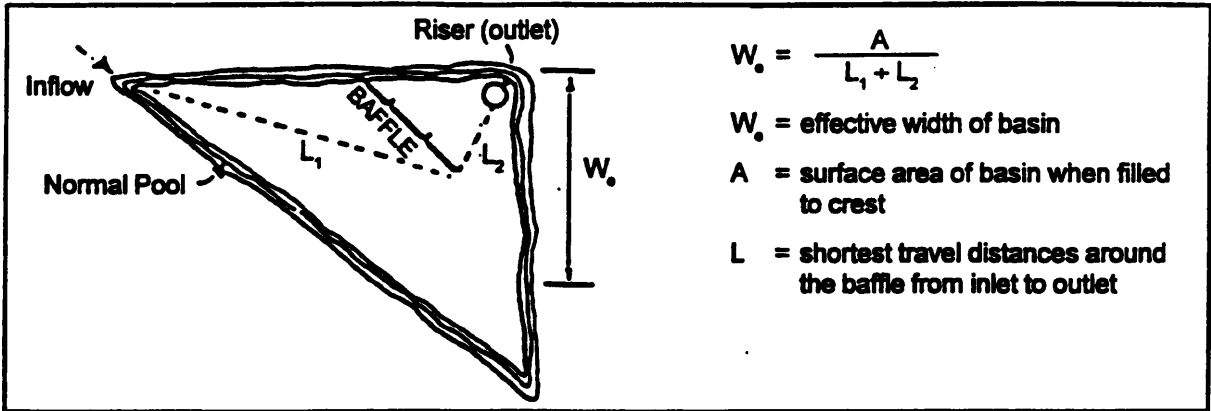




Figure 3-8 SEDIMENTATION POND BAFFLES



---

---

**CONTROL MEASURE: FILTER FABRIC FENCE.** (See also **Sediment Trap, Sediment Pond, Brush Barrier, and Inlet Barrier BMPs**).

**Purpose:** Intercepts and detains small amounts of sediment from disturbed areas during construction operations in order to prevent the sediment from leaving the site. **Filter fabric fences** also decrease the velocity of sheet flows and low to moderate channel flows. A filter fabric fence is a temporary structure of wood or steel fence posts, wire mesh fencing, and a suitable permeable filter fabric. Note: **filter fences** are applicable for sheet or overland flows, and cannot effectively filter large amounts of concentrated flow due to clogging. Therefore, they should be used in conjunction with a **sediment trap or pond** when the flow path length across the tributary basin exceeds 100 feet. Filter fences **shall not** be constructed across streams.

**Design Criteria/Specifications:** (1) Filter fences should be located a) immediately upstream of the runoff discharge point from a site, b) downslope of disturbed areas where runoff may occur in the form of sheet runoff, and c) in minor swales/ditches, prior to or following a **sediment trap/pond**, where concentrated flows do not exceed 0.5 cfs.; (2) See Figure 3-9 for design features; (3) The geotextile used must meet the standards listed below. A copy of the manufacturer's fabric specifications must be available on-site.

AOS (ASTM D-4751)	= 30-100 sieve size (0.60-0.15 mm) for silt film
Water Permittivity (ASTM D-4491)	= 0.02 sec <sup>-1</sup> min.
Grab Tensile Strength (ASTM D-4632)	= 180 lbs. Min. For extra strength fabric 100 lbs. Min. For standard strength fabric
Grab Tensile Elongation (ASTM D-4632)	= 30% max.
Ultraviolet resistance (ASTM D-4355)	= 70% min.

Standard strength fabric requires wire backing to increase the strength of the fence. Wire backing or closer post spacing may be required to extra strength fabric if field performance warrants a stronger fence. Where the fence is installed, the slope shall be no steeper than 2H:1V.

The following standard notes should appear with the Filter Fabric Fence Detail, in addition to any other standard notes:

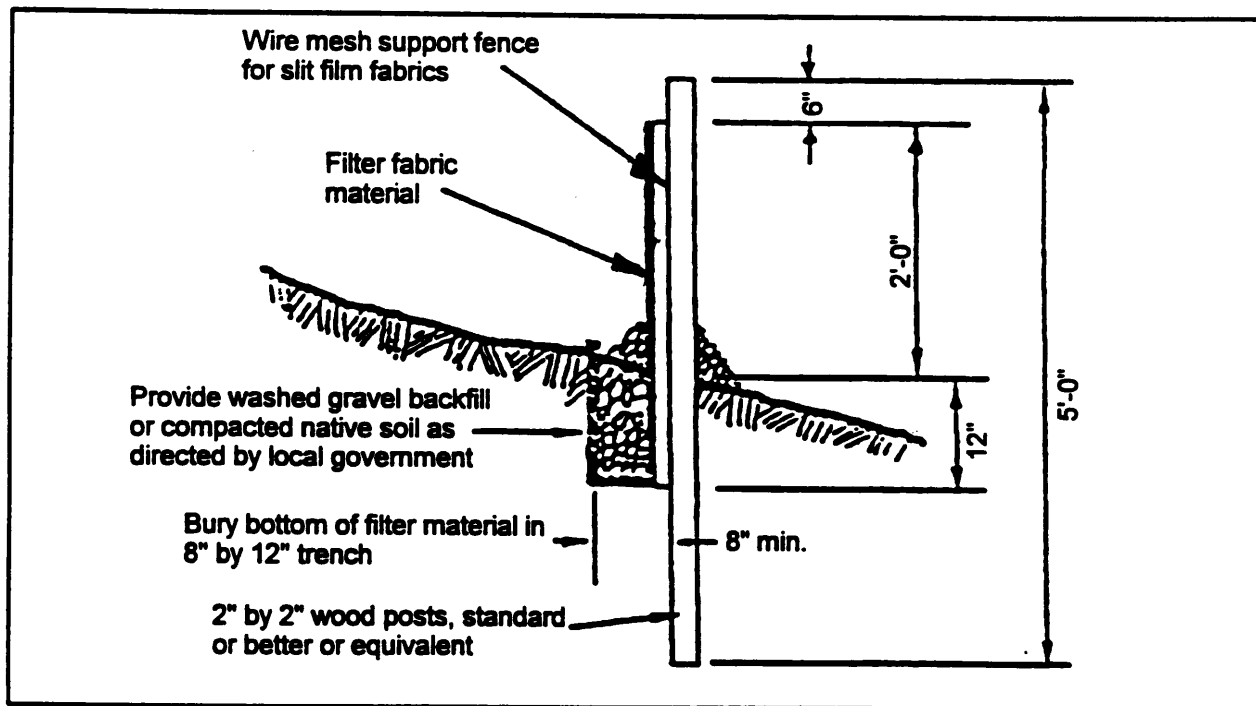
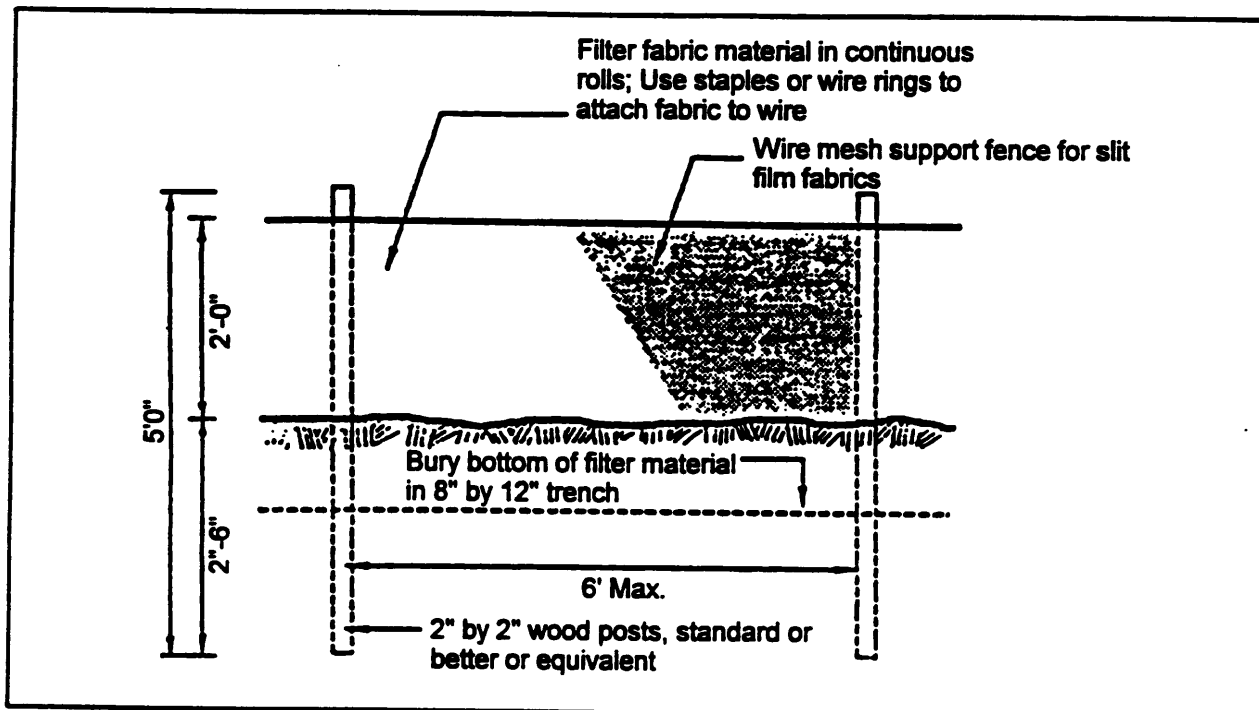
**Standard Notes:**

- a. The filter fabric shall be purchased in a continuous roll cut to the length of the barrier to avoid use of joints. When joints are necessary, filter fabric shall be spliced together only at a support post, with a minimum 6-inch overlap, and both ends securely fastened to the post.

- b. The filter fabric fence shall be installed to follow the contours (where feasible).
- c. When standard strength filter fabric is used, a wire support fence shall be fastened securely to the upslope side of the posts using heavy-duty wire staples at least 1-inch long, tie wires or hog rings. The wire shall extend into the trench a minimum of 4-inches. At least 24-inches or more above ground.
- d. Filter fabric shall not be stapled to existing trees.
- e. The trench shall be backfilled with 3/4-inch minimum diameter washed gravel.
- f. Filter fabric fences shall be inspected immediately after each rainfall and at least daily during prolonged rainfall. Any required repairs shall be made immediately.
- g. Filter fabric fences shall be removed when they have served their useful purpose, but not before the upslope area has been permanently stabilized.

**Maintenance:** (1) Filter fabric fences should be inspected immediately after each runoff-producing rainfall and at least daily during prolonged rainfall. Any required repairs should be made immediately; (2) Sediment should be removed when it reaches approximately one third the height of the fence (8-inch maximum), especially if heavy rains are expected; (3) Any sediment deposits remaining in place after the filter fence is no longer required should be dressed to conform with the existing grade, prepared, and seeded.

Figure 3-9 FILTER FABRIC FENCE



---

---

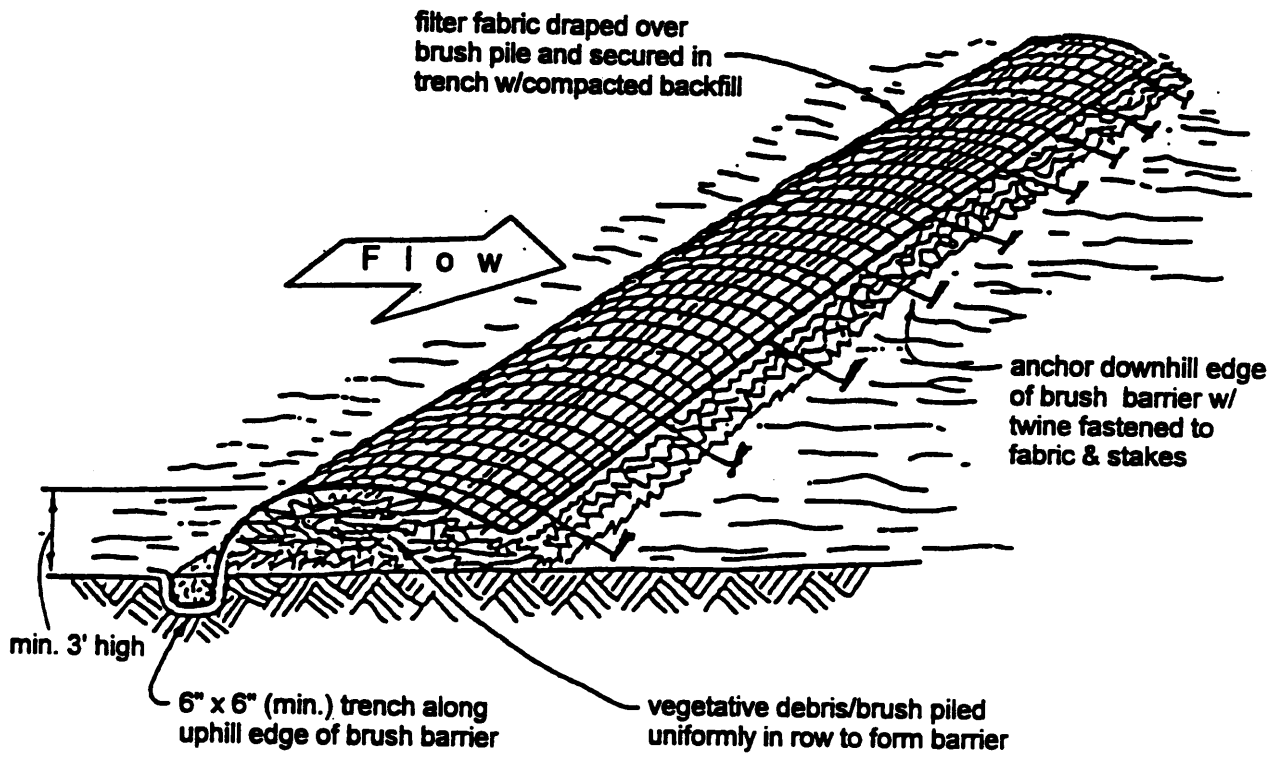
**CONTROL MEASURE: BRUSH BARRIER.** (See also **Filter Fabric Fence BMP**).

**Purpose:** Retains sediment from very small disturbed areas by construction of a temporary barrier made from residue materials available from clearing and grubbing the site.

**Design Criteria/Specifications:** (1) Locate below disturbed areas subject to sheet or rill erosion, where enough residue material is available for the construction of such a barrier, and where the disturbed area is less than 1/4 acre; (2) A **brush barrier** should not be considered a replacement for a **sediment trap** or **sediment pond**; (3) See Figure 3-10 for design features; (4) Minimum height = 3-feet, maximum height = 5-feet; (4) Minimum width, front to back, = 5-feet at base, maximum width = 15-feet; (5) To enhance the **brush barrier's** filtration capacity, the designer should consider specifying **filter fabric** anchored over the brush berm. The fabric shall be secured on the uphill side in the trench with compacted backfill, and staked on the downhill side.

**Maintenance:** (1) Brush barriers generally require little maintenance, unless there are very heavy deposits of sediment. Occasionally, tearing of the fabric may occur; (2) When the barrier is no longer needed the fabric can be removed to allow natural establishment of vegetation. Over time, the barrier will decompose.

Figure 3-10 BRUSH BARRIER



---

---

**CONTROL MEASURE: GRAVEL FILTER BERM.**

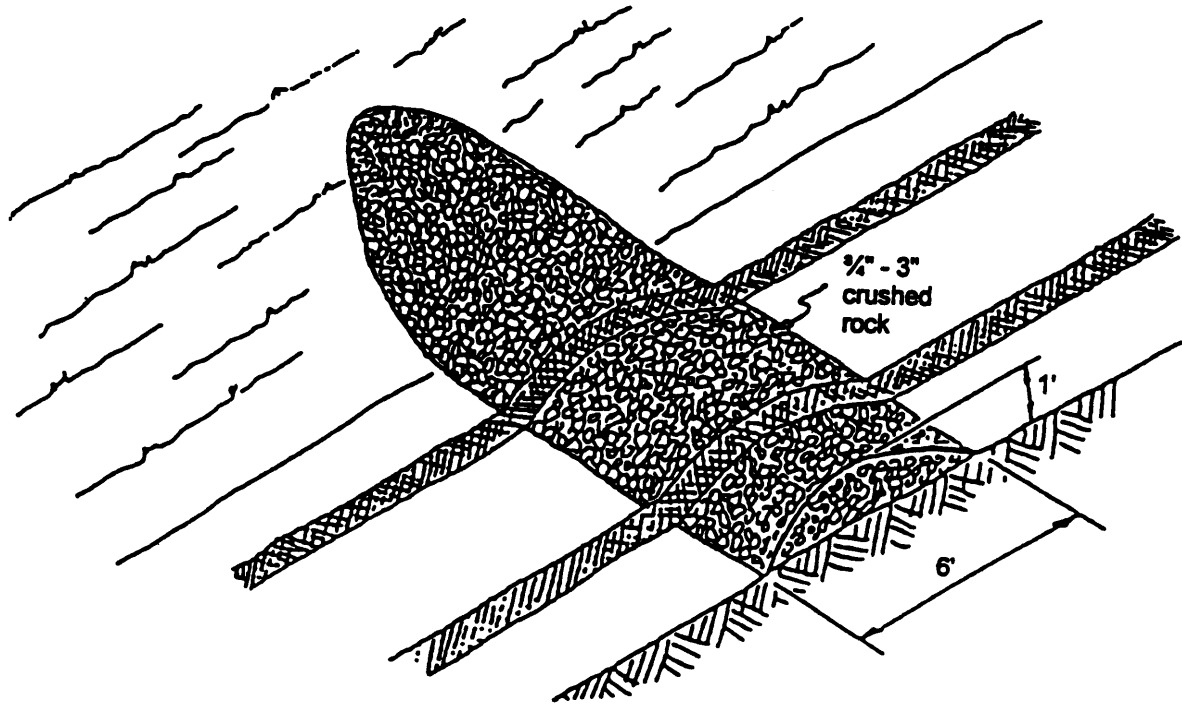
**Purpose:** Intercepts and temporarily retains sediment from rights-of-way or in traffic areas on construction sites where durability and large sediment capacity is required. This is a very efficient method of sediment removal.

**Design Criteria/Specifications:** (1) See Figure 3-11 for design features; (2) Berm material should be 3/4-inch to 3-inch well-graded gravel or crushed rock with less than 5% fines; (3) Berm dimensions should be 1-foot high with 3:1 side slopes; (4) Berms should be spaced as follows:

Distance Between Berms (Feet)	Maximum Slope (%)
300	5
200	10
100	>10

**Maintenance:** Gravel Filter Berms should be inspected regularly, and immediately after each rainfall and at least daily during prolonged rainfall. Sediment should be removed and filter material replaced as needed.

Figure 3-11 GRAVEL FILTER BERM





---

---

**CONTROL MEASURE: STRAW/HAY BALE BARRIER.**

**Purpose:** Intercepts and detains small amounts of sediment from disturbed areas of limited extent, preventing sediment from leaving the project site, and also decreases the velocity of sheet flow from the face of steep slopes.

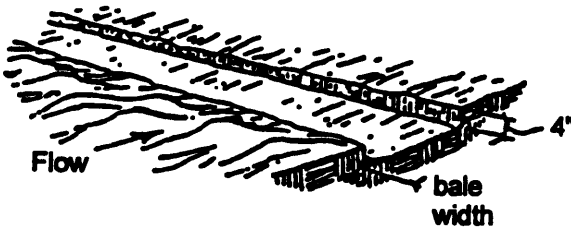
**Design Criteria/Specifications:** (1) See Figure 3-12 and 3-13 for design features; (2) Locate below disturbed areas subject to sheet and rill erosion, where the size of the drainage area is no greater than 1/4 acre per 100 feet of barrier length, where the maximum slope length behind the barrier is 100 feet (50 feet if the slope is steeper than 10%), and where the maximum slope gradient behind the barrier is 50% (2:1); (3) Locate in minor swale or ditch lines where the maximum contributing drainage area is no greater than 2 acres; (4) Straw/hay bale barriers should **not** be used where their effectiveness is required for more than 3 months; (5) For sheetflow applications: a) Bales should be placed in a single row, lengthwise on the contour, with ends of adjacent bales tightly abutting one another; b) All bales should be either wire-bound or string-tied. Straw bales should be installed so that bindings are oriented around the sides rather than along the tops and bottoms of the bales in order to prevent deterioration of the bindings; c) The barrier should be entrenched and backfilled. A trench should be excavated the width of the bale and the length of the proposed barrier to a minimum depth of 4-inches. The trench should be deep enough to remove all grass and other material which might allow underflow. After the bales are staked and chinked (filled by wedging), the excavated soil should be backfilled against the barrier. Backfill soil should conform to the ground level on the downhill side and should be built up to 4-inches against the uphill side of the barrier; d) Each bale should be securely anchored by at least 2 stakes or rebars driven through the bale. The first stake in each bale should be driven toward the previously laid bale to force the bales together. Stakes or rebars should be driven deep enough into the ground to securely anchor the bales. Stakes should not extend above the bales but instead should be driven flush with the top of the bale for safety reasons; e) The gaps between the bales should be chinked (filled by wedging) with straw to prevent water from escaping between the bales. Loose straw scattered over the area immediately uphill from a straw bale barrier tends to increase barrier efficiency. Wedging should be done carefully in order not to separate the bales; (6) In channel flow applications: a) The bales should be placed in a single row, lengthwise, oriented perpendicular to the direction of flow, with ends of adjacent bales tightly abutting one another; b) The remaining steps for installing a straw bale barrier for sheetflow applications apply here, except that the barrier should be extended to such a length that the bottoms of the end bales are higher in elevation than the top of the lowest middle bale to assure that sediment-laden runoff will flow either through or over the barrier but not around it.

**Maintenance:** (1) Straw/Hay bale barriers should be inspected immediately after each runoff-producing rainfall and at least daily during prolonged rainfall; (2) Close attention should be paid to the repair of damaged bales, end runs, and undercutting beneath bales; (3) Necessary repairs to barriers or replacement of bales should be accomplished

promptly; (4) Sediment deposits should be removed after each runoff-producing rainfall. They should be removed when the level of deposition reaches approximately 1/3 the height of the barrier; (5) Any sediment deposits remaining in place after the straw bale barrier is no longer required should be dressed to conform to the existing grade, prepared and seeded; (6) Straw/hay bale barriers are temporary and have a life expectancy of 3 months or less. They should be removed and replaced with new bales until upslope areas have been stabilized.

Figure 3-12 STRAW/HAY BALE BARRIER

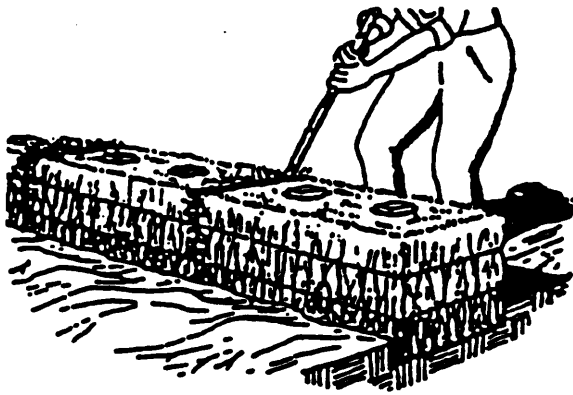
1. Excavate the trench.



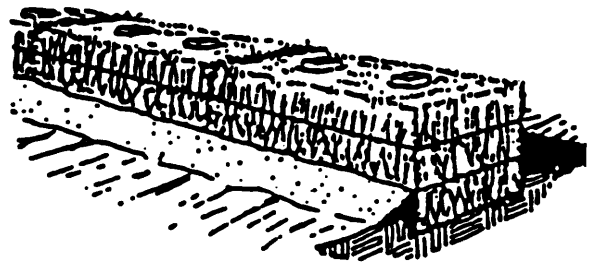
2. Place and stake straw bales.



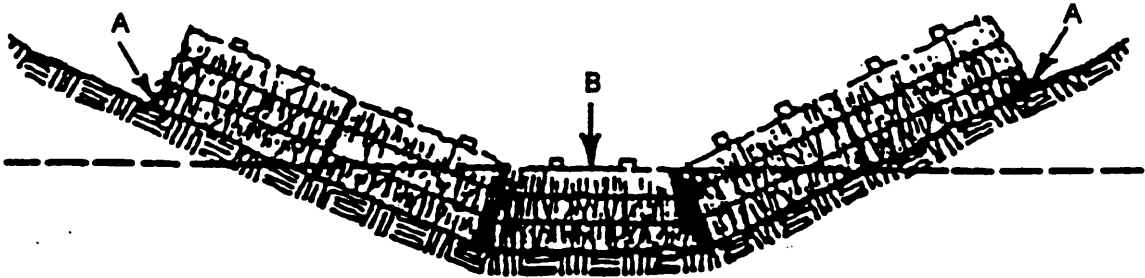
3. Wedge loose straw between bales.



4. Backfill and compact the excavated soil.



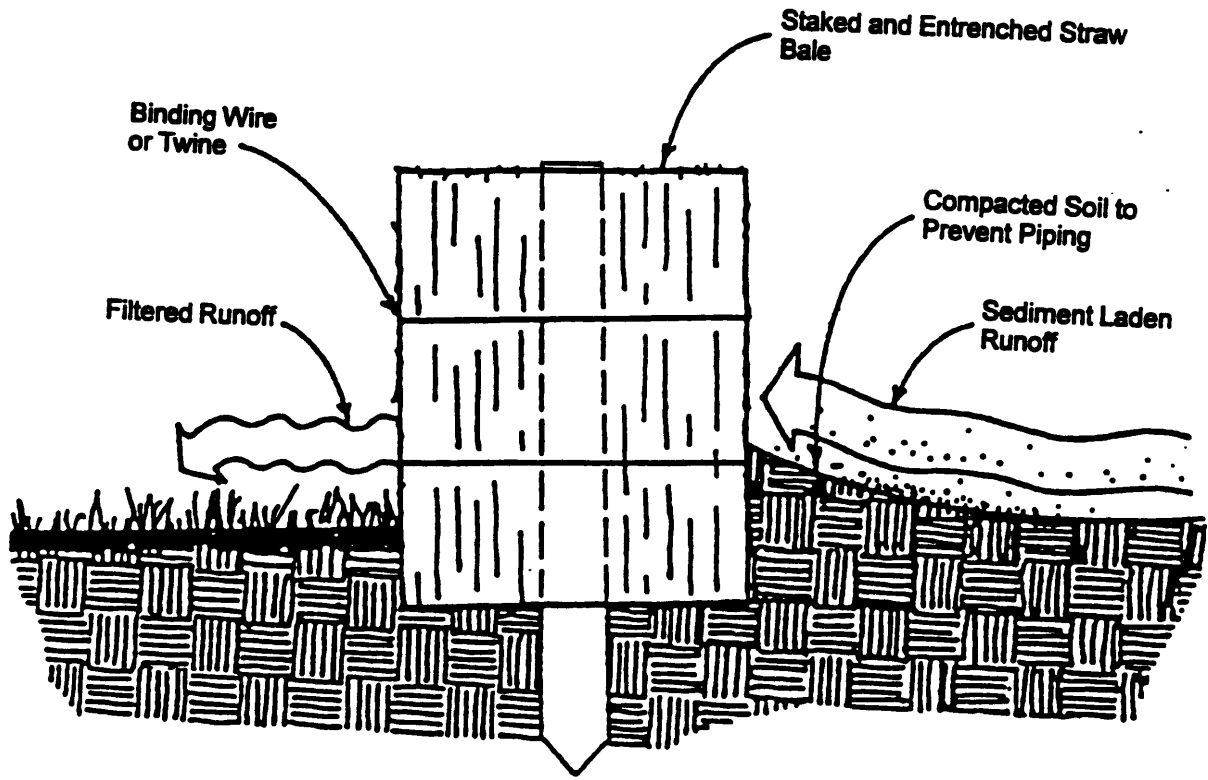
**Construction of A Straw Bale Barrier**



Points A should be higher than point B

**Proper Placement of Straw Bale Barrier in Drainage Way**

Figure 3-13 STRAW BALE CHECK DAM



---

---

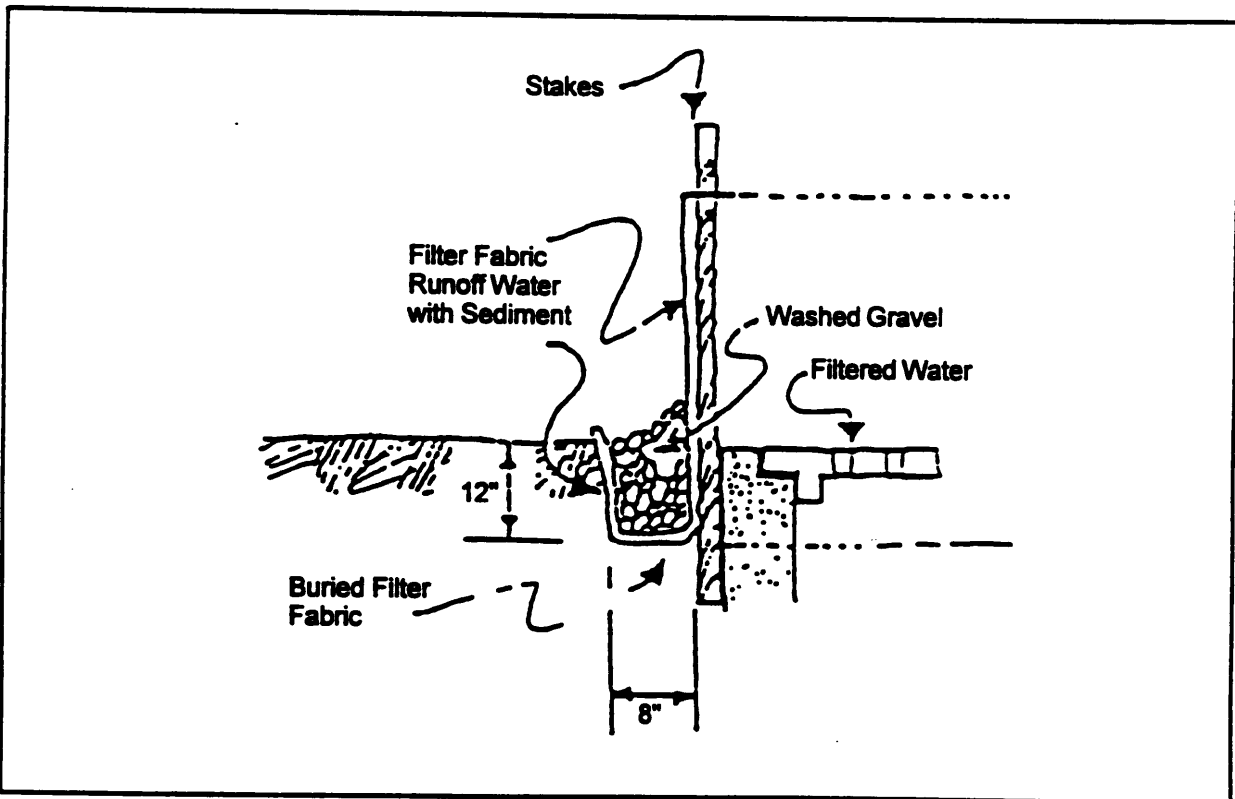
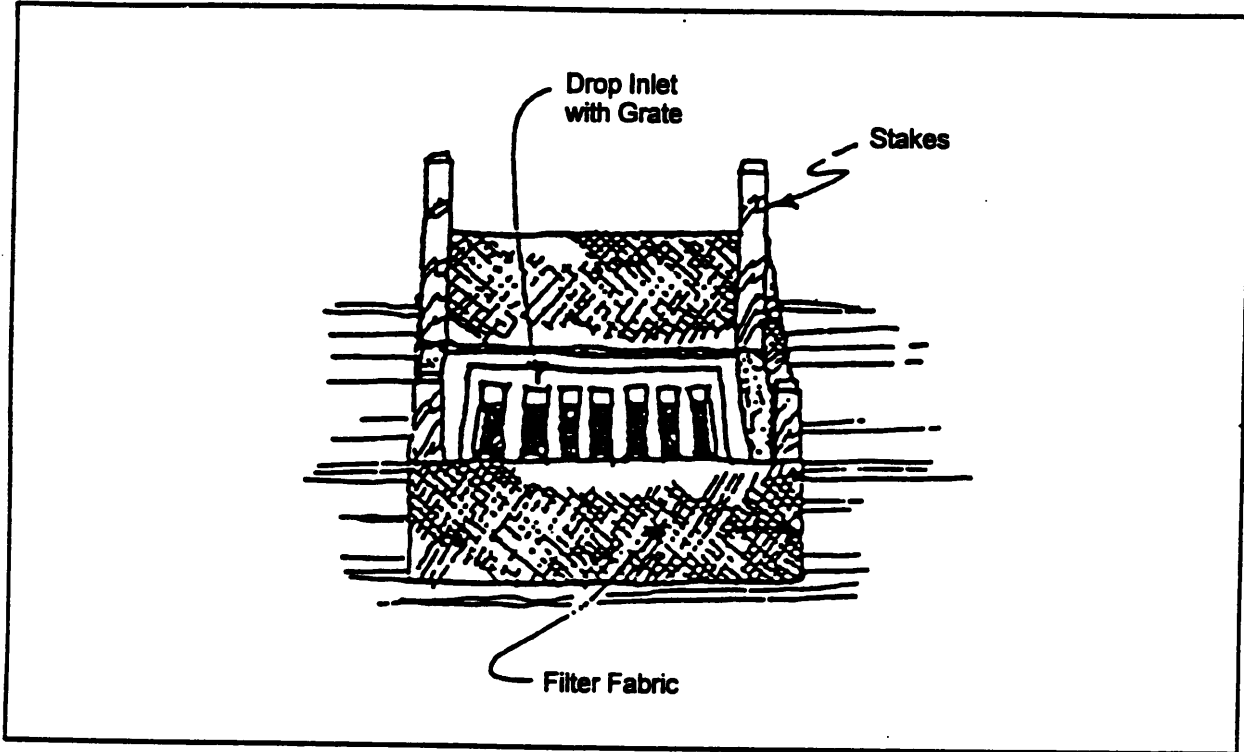
**CONTROL MEASURE: FILTER FABRIC FENCE INLET BARRIER.**

**Purpose:** Prevents sediment from entering storm drainage system prior to permanent stabilization of the disturbed area.

**Design Criteria/Specifications:** (1) This device is applicable where the inlet drains a relatively small (less than 1 acre) flat area (less than 5% slope); (2) See Figure 3-14 for design features; (3) Place 2" x 2" wooden stakes around the perimeter of the inlet a maximum of 3-feet apart and drive them at least 18- inches into the ground. The stakes must be at least 3-feet long; (4) Excavate a trench approximately 8- inches wide and 12-inches deep around the outside perimeter of the stakes; (5) Staple the **filter fabric** (material specifications: see the section on **Filter Fabric Fence**) to the wooden stakes so that 32-inches of the fabric extends and can be formed into the trench. Use heavy-duty wire staples at least ½-inch long; (6) Backfill the trench with ¾-inch minus washed gravel all the way around; (7) Do not place fabric under the grate, as the collected sediment may fall into the drain when the fabric is retrieved.

**Maintenance:** Inspections should be made on a regular basis, especially after large storm events. If the fabric becomes clogged, it should be replaced. Sediment should be removed when it reaches approximately 1/3 the height of the fence. If a sump is used, sediment should be removed when it fills approximately 1/3 the depth of the hole.

Figure 3-14 FILTER FABRIC FENCE INLET BARRIER



---

---

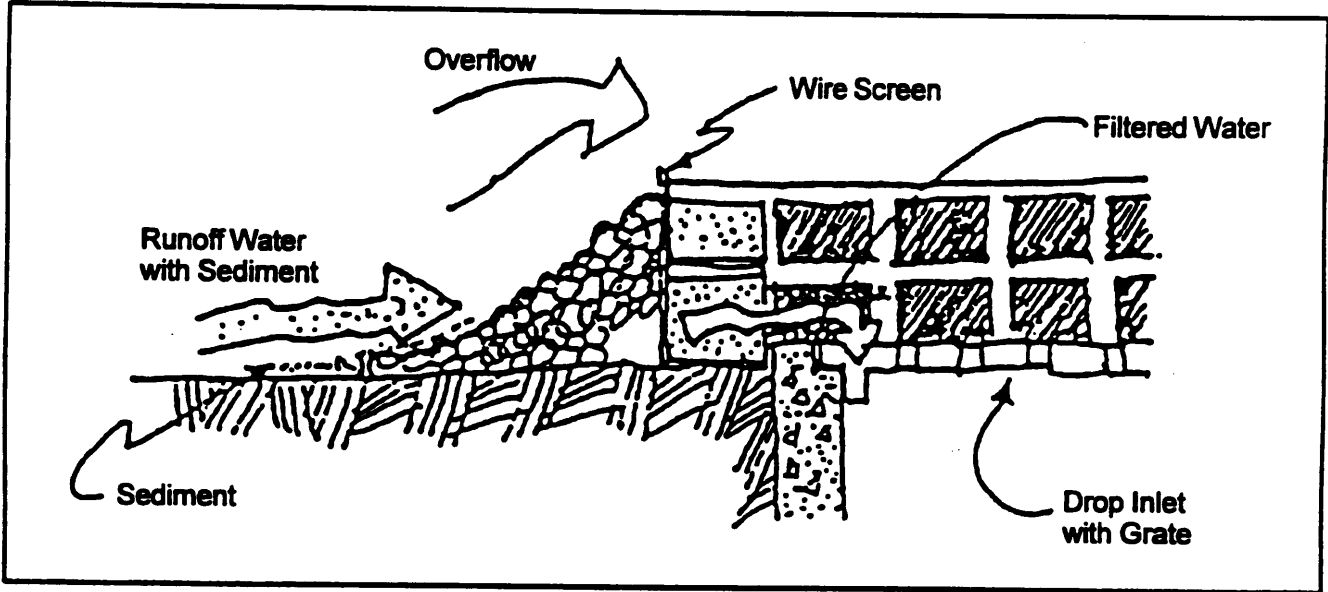
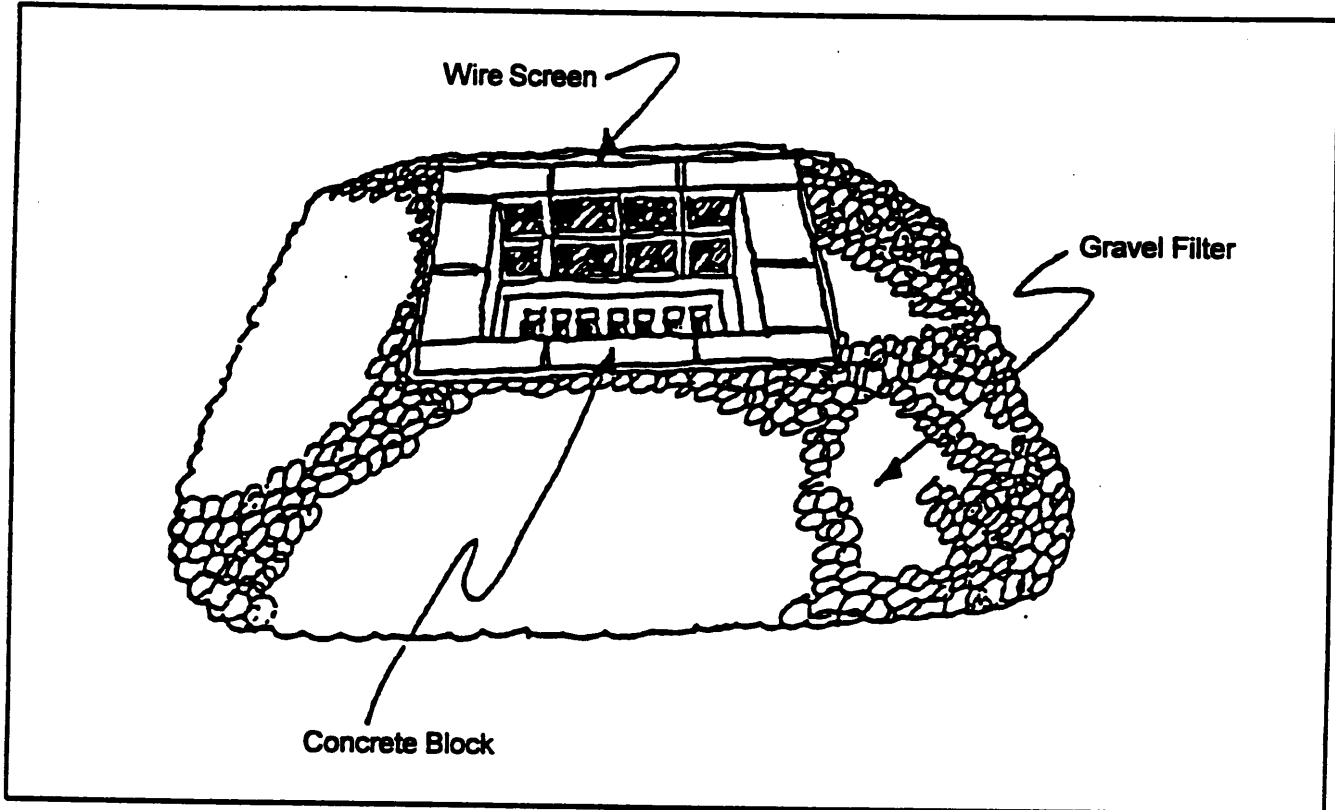
**CONTROL MEASURE: BLOCK AND GRAVEL FILTER INLET BARRIER.**

**Purpose:** Prevents sediment borne in heavy runoff flows from entering a storm drainage system prior to permanent stabilization of the disturbed area.

**Design Criteria/Specifications:** (1) This device is applicable where flows greater than 0.5 cfs are expected, but inlet will not be exposed to traffic; (2) See Figure 3-15 for design features; (3) Place concrete blocks lengthwise on their sides in a single row around the perimeter of the inlet, so that the open ends face outward, not upward. The ends of adjacent blocks should abut. The height of the barrier can be varied, depending on design needs, by stacking combinations of blocks that are 4-inches, 8-inches and 12-inches wide. The row of blocks should be at least 12-inches but not greater than 24-inches high; (4) Place wire mesh over the outside vertical face (open end) of the concrete blocks to prevent stone from being washed through the blocks. Use hardware cloth or comparable wire mesh with ½-inch openings; (5) Pile stone against the wire mesh to top of the blocks. Use ¾- to 3-inch washed gravel.

**Maintenance:** (1) Inspections should be made on a regular basis, especially after large storm events. Sediment should be removed when it reaches approximately 1/3 the height of the barrier. If a sump is used, sediment should be removed when it fills approximately 1/3 the depth of the hole; (2) If the stone filter becomes clogged with sediment, the stones must be pulled away from inlet and cleaned or replaced. Since cleaning of gravel at a construction site may be difficult, an alternative approach would be to use the clogged stone as fill and put fresh stone around the inlet.

Figure 3-15 BLOCK AND GRAVEL FILTER INLET BARRIER





---

---

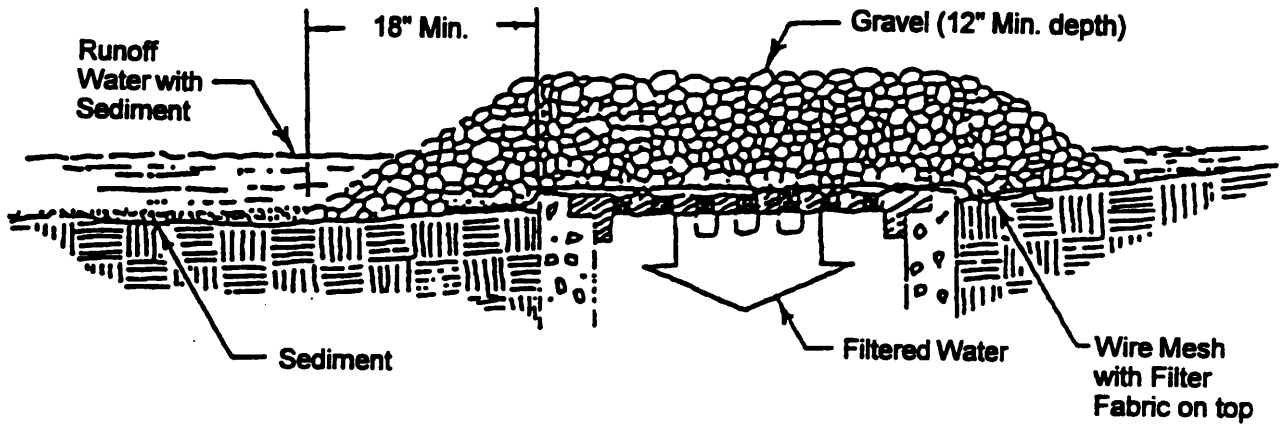
**CONTROL MEASURE: GRAVEL AND WIRE MESH FILTER INLET BARRIER.**

**Purpose:** Prevents sediment from entering a storm drainage system prior to permanent stabilization of the disturbed area, while protecting the temporary inlet barrier from construction traffic.

**Design Criteria/Specifications:** (1) This device is applicable where flows greater than 0.5 cfs are expected and construction traffic may occur over the inlet; (2) See Figure 3-16 for design features; (3) Place wire mesh over the drop inlet so that the wire extends a minimum of 1 foot beyond each side of the inlet structure. Use hardware cloth or comparable wire mesh with ½-inch openings. If more than one strip of mesh is necessary, overlap the strips. Place filter fabric (material specifications: see the section on **Filter Fabric Fence**) over wire mesh; (4) Extend the filter fabric beyond the inlet opening at least 18-inches on all sides. Place ¾- to 3-inch washed gravel over the filter fabric/wire mesh. The depth of the gravel should be at least 12-inches over the entire inlet opening.

**Maintenance:** (1) Inspections should be made on a regular basis, especially after large storm events. Sediment should be removed when it reaches approximately 1/3 the height of the gravel. If a sump is used, sediment should be removed when it fills approximately 1/3 the depth of the hole; (2) If the stone filter becomes clogged with sediment, the stones must be pulled away from the inlet and cleaned or replaced. Since cleaning of gravel at a construction site may be difficult, an alternative approach would be to use the clogged stone as fill and put fresh stone around the inlet; (3) If the **filter fabric** becomes clogged, it should be replaced.

Figure 3-16 GRAVEL AND WIRE MESH FILTER INLET BARRIER



---

---

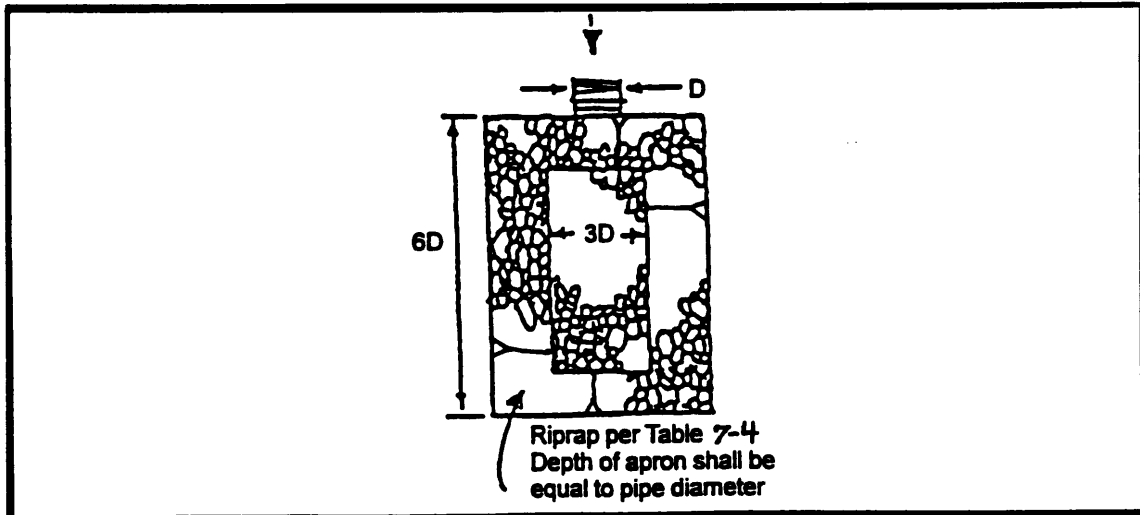
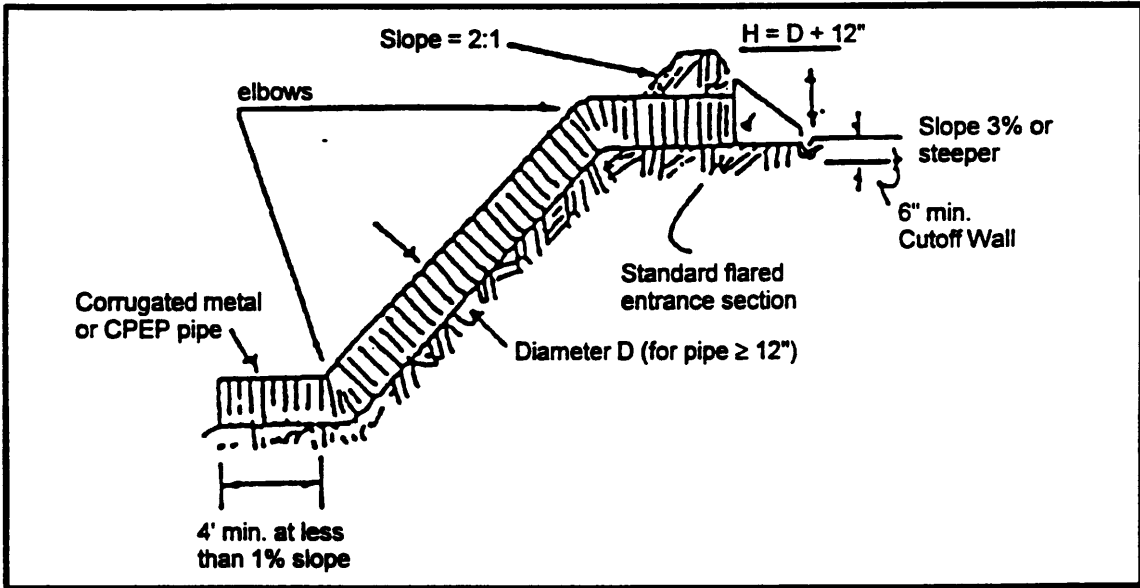
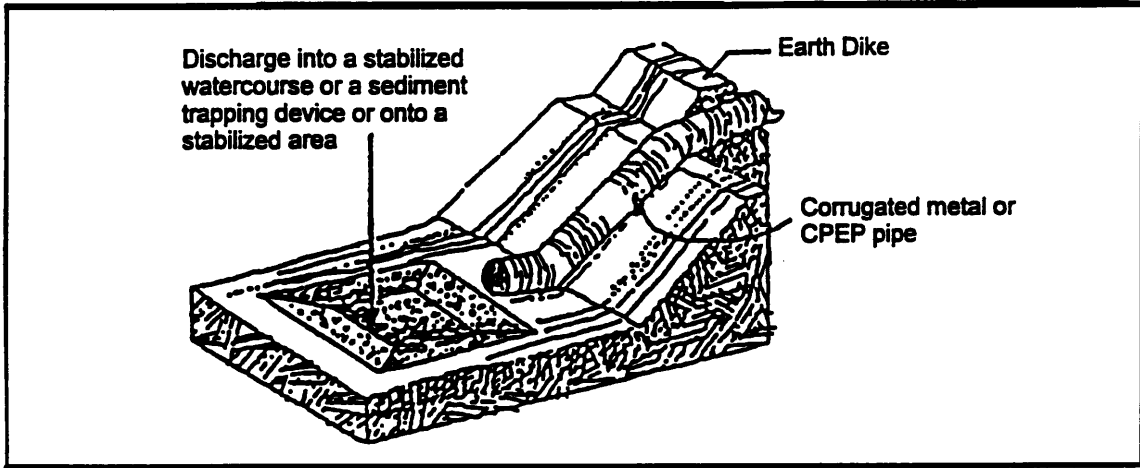
**CONTROL MEASURE: PIPE SLOPE DRAINS.** (See also **Interceptor Dike/Berm and Swale BMP**).

**Purpose:** Carries concentrated runoff down steep slopes without gullies, channel erosion, or saturation of slide-prone soils. Temporary pipe slope drains can provide valuable protection of exposed slopes until permanent drainage structures can be installed.

**Design Criteria/Specifications:** (1) When used in conjunction with **interceptor dikes/berms and swales**, temporary pipe slope drains can be used to convey stormwater from the entire drainage area above a slope to the base of the slope without erosion. It is very important that these temporary structures be installed properly since their failure will often result in severe gully erosion. The entrance section should be securely entrenched, all connections should be watertight, and the conduit should be anchored securely; (2) See Figure 3-17 for design features; (3) The capacity for temporary drains should be sufficient to handle the peak flow from a 10-year, 24-hour design storm (may be computed using the Rational Method); (4) The maximum drainage area per pipe should be 10 acres. For larger areas, a rocklined channel should be installed (see **Rip Rap BMP**), or more than one pipe should be installed; (5) The entrance should consist of a standard flared end section for drain pipes 12-inches and larger with a minimum 6-inch toe plate to prevent runoff from undercutting the pipe inlet. The slope of the entrance should be at least 3 percent; (6) The soil around and under the pipe and entrance section should be thoroughly compacted; (7) The flared inlet section should be securely connected to the slope drain and have gasketed, watertight connecting bands; (8) Slope drain sections should be securely fastened together and have gasketed watertight fittings, and be securely anchored into the soil; (9) Interceptor dikes should be used to direct runoff into a slope drain. The height of the dike should be at least 1-foot higher at all points than the top of the inlet pipe; (10) The area below the outlet should be stabilized with a rip rap apron (see **Rip Rap BMP**). If the pipe slope drain may convey sediment-laden runoff, it should be directed to a **sediment trap/pond**.

**Maintenance:** Inlet and outlet points should be checked regularly, and especially after heavy storms. The inlet should be free of undercutting, and no water should be going around the point of entry. If there are problems, the headwall should be reinforced with compacted earth or sand bags. The outlet point should be free of erosion and installed with appropriate outlet protection.

Figure 3-17 PIPE SLOPE DRAIN



---

---

**CONTROL MEASURE: INTERCEPTOR DIKE/BERM AND SWALE. (See also Pipe Slope Drains).**

**Purpose:** Intercepts storm runoff from drainage areas above unprotected slopes and directs it to a stabilized outlet. When placed above a slope, it reduces the volume of water reaching the disturbed area by intercepting runoff from above. When placed horizontally across a slope following the contours, it reduces the velocity of runoff flowing down the slope by reducing the distance that the runoff can flow directly downhill.

**Design Criteria/Specifications:** (1) See Figure 3-18 for design features; (2) Minimize construction traffic over temporary dikes; (3) Dikes/Berms should meet the following design criteria:

Top Width:	2 feet minimum.
Height:	18-inches minimum. Measured from upslope toe and at a compaction of 90% Modified Proctor.
Side Slopes:	2:1 or flatter.
Grade (along toe of dike or berm):	Topography dependent, except that dikes should be limited to grades not exceeding 5%, with positive drainage to a suitable outlet.
Stabilization:	Use appropriate BMPs for sheet flow based on runoff velocities and dike materials.
Outlet:	The upslope side of the dike should provide positive drainage to the dike outlet. No erosion should occur at the outlet. Provide energy dissipation measures as necessary. Sediment-laden runoff should be released through a <b>sediment trap and/or sediment pond</b> .

(4) Interceptor swales should meet the following design criteria:

Bottom Width:	2 feet minimum; the bottom width should be level.
Depth:	1 foot minimum.
Side Slopes:	2:1 or flatter.
Grade of swale:	Maximum 5%, with positive drainage to a suitable outlet (such as a <b>sediment trap and/or sediment pond</b> ).

**Stabilization:** Apply **erosion control seed** or rock. Rock should be 12-inches thick, pressed into the bank and extending at least 8-inches vertical from the bottom.

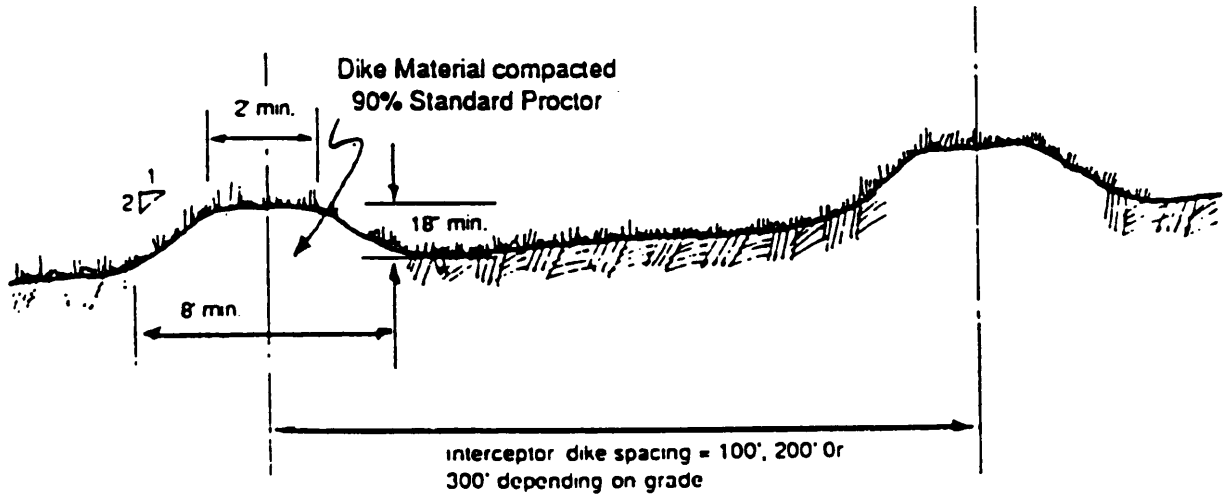
**Outlet:** **Level spreader or rip rap** to stabilized outlet **sediment trap and/or sediment pond.**

(5) Dike/berm and swale spacing should meet the following criteria:

<u>Slope of disturbed area</u>	<u>Spacing</u>
< 5%	300 feet
5% - 10%	200 feet
10% - 25%	100 feet
25% - 50%	50 feet

**Maintenance:** The dike/berm or swale should be inspected after every major storm and repairs made as necessary. Damage caused by construction traffic or other activity should be repaired before the end of each working day.

Figure 3-18 INTERCEPTOR DIKE/BERM AND SWALE



### Interceptor Dike

---

---

**CONTROL MEASURE: SUBSURFACE DRAINS.** (See also **Filter Fabric Fence, Sediment Trap or Sediment Pond BMPs**).

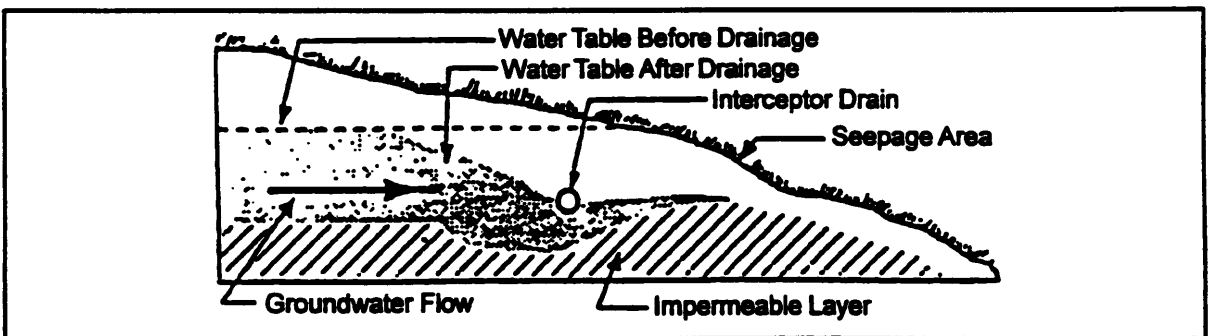
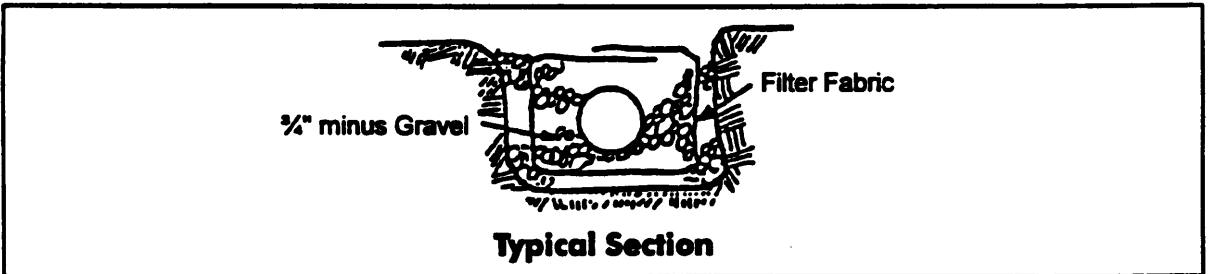
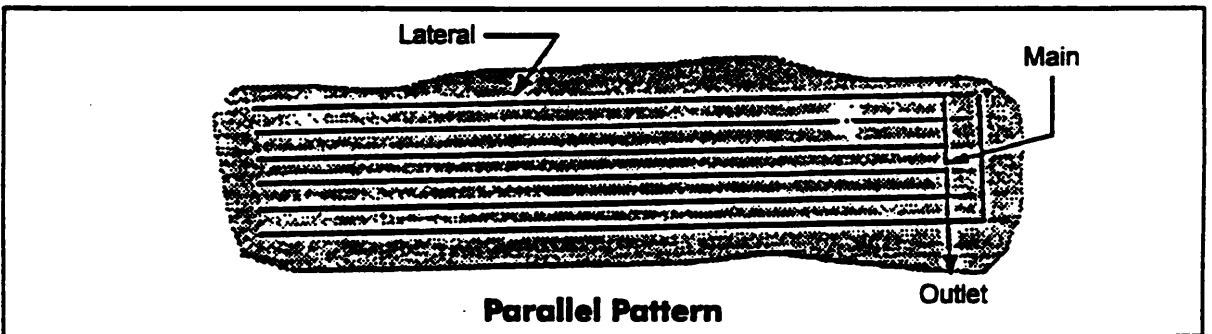
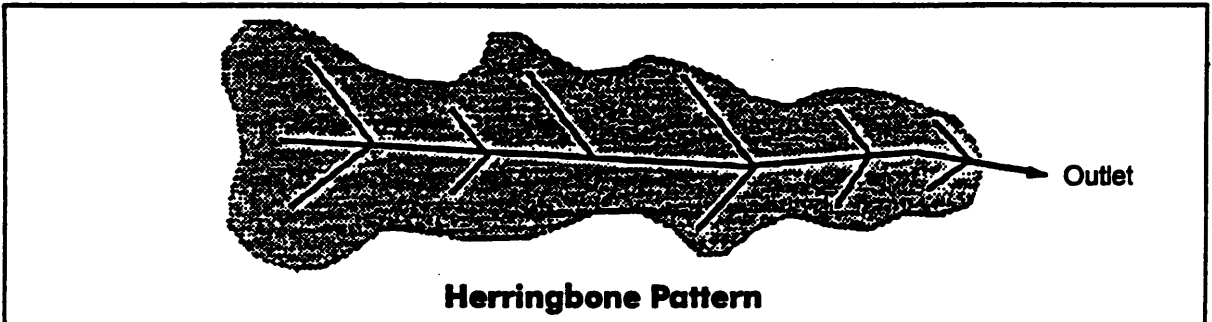
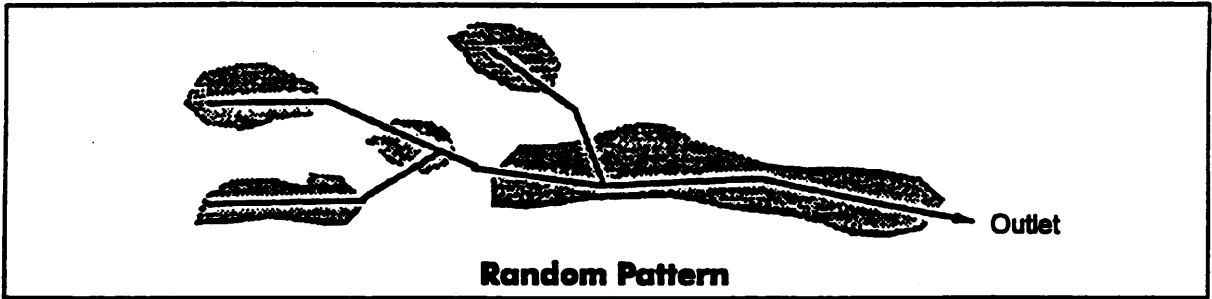
**Purpose:** Provides a dewatering mechanism for draining excessively wet, sloping soils; usually consists of an underground perforated pipe that will intercept and convey groundwater.

**Design Criteria/Specifications:** (1) See Figure 3-19 for design features; (2) Subsurface drains may be relief drains or interceptor drains. Relief drains are used either to lower the water table or to remove surface water. They are installed along a slope and drain in the direction of the slope. They can be installed in a parallel pattern, a herringbone pattern, or a random pattern. Interceptor drains are used to remove water as it seeps down a slope to prevent the soil from becoming saturated and subject to slippage. They are installed across a slope and drain to the side of the slope. They usually consist of a single or a series of single pipes instead of a patterned layout; (3) Subsurface drains should be sized for the required capacity; (4) The minimum effective diameter for a subsurface drain should be 4-inches; (5) The minimum velocity recommended to prevent silting is 1.4 ft/sec. The line should be laid to achieve at least this velocity; (6) Gravel and **filter fabric** should be used around all drains for proper bedding and filtration of fine materials; (7) The outlet of the subsurface drain should empty into a **sediment trap or sediment pond**. If free of sediment, it should empty into a receiving channel, swale or stable vegetated area. The outlet should be adequately protected from erosion and undermining; (8) The strength and durability of the pipe should be adequate for site conditions in accordance with the manufacturer's specifications; (9) The trench should be constructed on a continuous grade with no reverse grades or low spots; (10) Soft or yielding soils under the drain should be stabilized with gravel or other suitable material; (11) Deformed, warped or otherwise unsuitable pipe should not be used; (12) Backfilling should be done immediately after placement of pipe. No sections of pipe should remain uncovered overnight. Backfill material should be placed in the trench in such a manner that the drain pipe is not displaced or damaged.

**Maintenance:** (1) Subsurface drains should be checked periodically to insure that they are free-flowing and not clogged with sediment; (2) The outlet should be kept clean and free of debris; (3) Surface inlets should be kept open and free of sediment and other debris; (4) Trees located too close to a subsurface drain often clog the system with their roots. If a drain becomes clogged, relocate the drain or remove the trees (if tree removal is permitted); (5) Where drains are crossed by heavy vehicles, the line should be checked to insure that it is not crushed.



Figure 3-19 SUBSURFACE DRAIN



---

---

**CONTROL MEASURE: COVER AND PROPERLY LOCATE STOCKPILES.**  
(See also **Filter Fabric Fence, Interceptor Dike/Berm and Swale, Plastic Sheeting, Mulching, Nets and Mats**).

**Purpose:** Covering and properly locating earth stockpiles can reduce or prevent excessive erosion of the stockpiled material.

**Design Criteria/Specifications:** (1) Earth stockpiles should be set back at least 50 feet from downslope drainage features (e.g. channels, catch basins, detention ponds, pavement, stream banks, critical drainage areas); (2) Stockpiles should be located on the uphill side of the excavated area wherever possible so that they can act as diversions; (3) Earth stockpiles should not be placed on pavement without implementation of a procedure to prevent sediment transport; (4) Earth stockpiles should be completely covered or otherwise stabilized with an appropriate BMP on a daily basis during winter months and within 30 days during dry seasons. (5) The bottom of a stockpile should be circled with an interceptor swale and/or **filter fabric fence** to catch sediment-laden runoff from the stockpile.

---

---

**CONTROL MEASURE: RESTRICT PLACEMENT OF CONSTRUCTED SLOPES OR EARTHWORKS. (See also Plastic Sheeting, Nets and Mats BMPs).**

**Purpose:** Prevent the likelihood of earth material sloughing, sliding or eroding into natural water bodies.

**Design Criteria/Specifications:** (1) Do not locate cut or fill slopes near natural bodies of water; (2) Do not dump or otherwise place earth into, or in the proximity of, natural bodies of water; (3) Exposed soil at stream crossings or near other natural bodies of water which could slough into the water should not be left at an angle steeper than 2:1 unless engineered and reinforced to withstand sloughing and erosion; (4) A filter fabric fence (or other sediment trapping device) should be placed at the toe of slopes located near natural bodies of water or streams; (5) exposed soil located in the immediate tributary area of a natural body of water should be stabilized on a daily basis using slope covering such as **plastic sheeting, nets and mats**, or other means which will positively prevent erosion; (6) Roads and approaches over culverts should be stabilized with crushed rock or other appropriate means within 24 hours of reaching grade.

Note that Hydraulic Project Approval permits (State of Washington Department of Fish and Wildlife) are required for work at stream crossings. Also note that work near or in streams or other natural bodies of water may be subject to additional requirements of other ordinances regarding critical areas and wetlands.

---

---

**CONTROL MEASURE: STRUCTURAL STREAMBANK STABILIZATION.**  
(See also **Rip Rap BMP**).

**Purpose:** Protects stream banks from the erosive forces of moving water by construction of permanent structural measures.

**Design Criteria/Specification:** (1) Design should be based on criteria and input/review from a qualified fisheries biologist; (2) Since each reach of a channel requiring protection is unique, measures for streambank protection should be installed according to a plan and adapted to the specific site; (3) See Chapter 7, Collection and Conveyance Facilities, concerning open channels and bank stabilization; (4) Structural streambank stabilization measures should conform to Department of Fish and Wildlife permit requirements.

Note that Hydraulic Project Approval permits (State of Washington Department of Fish and Wildlife) are required for work at stream crossings. Also note that work near or in streams or other natural bodies of water may be subject to additional requirements of other ordinances regarding critical areas and wetlands.

---

---

**CONTROL MEASURE: VEGETATIVE STREAMBANK STABILIZATION.**

**Purpose:** Protects stream banks from erosive forces of moving water through the use of vegetation.

**Design Criteria/Specifications:** Streambank stabilization design should be based on criteria and input/review from a qualified fisheries biologist. See also Chapter 7, Collection and Conveyance Facilities, concerning open channels and streambank stabilization.

Note that Hydraulic Project Approval permits (State of Washington Department of Fish and Wildlife) are required for work at stream crossings. Also note that work near or in streams or other natural bodies of water may be subject to additional requirements of other ordinances regarding critical areas and wetlands.

---

---

**CONTROL MEASURE: OUTLET PROTECTION.** (See also **Rip Rap BMP**).

**Purpose:** Prevents scour at channel or pipe outlets, minimizes potential for downstream erosion or flooding by reducing the velocity of concentrated stormwater flows.

**Design Criteria/Specifications:** (1) All outfalls should be provided with a rock splash pad; (2) Mechanisms which reduce velocity prior to discharge from an outfall are encouraged (e.g. drop manholes or rapid expansion into pipes of larger diameter); (3) See Table 7-4 in Chapter 7, for recommended rock sizes for rock protection at outfalls; (4) Engineered energy dissipators must be used for outfalls with velocity at design flow greater than 20 fps.

**Maintenance:** Inspect regularly and following heavy rainfall events and restore or replace damaged facilities. The outlet should remain free of undercutting.

---

---

**CONTROL MEASURE: LEVEL SPREADER**

**Purpose:** Reduces the velocity of concentrated runoff and converts concentrated runoff to sheetflow for release onto areas stabilized by existing vegetation.

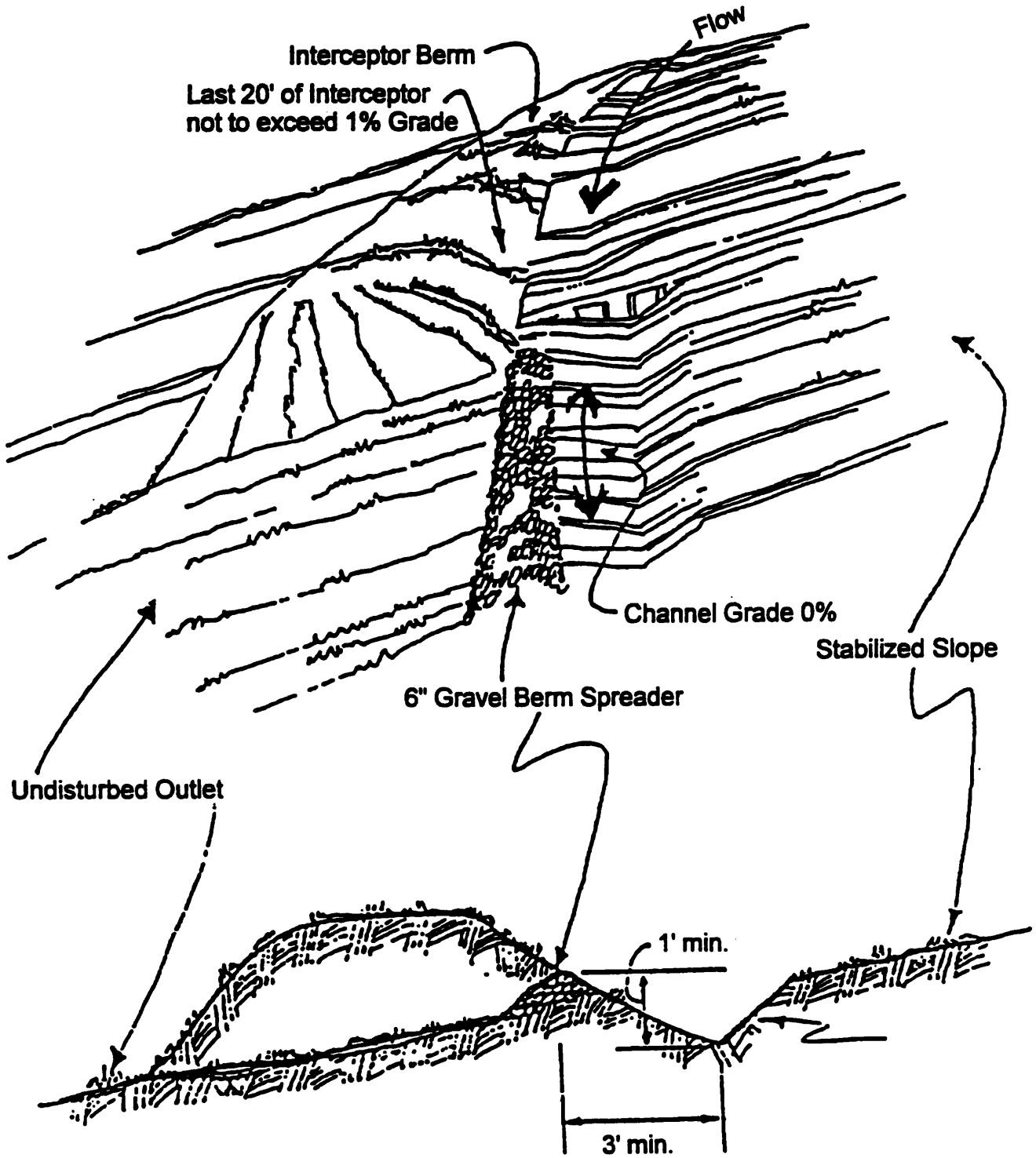
**Design Criteria/Specifications:** (1) See Figure 3-20 for design features; (2) The grade of the channel for the last 20 feet before entering the level spreader should be less than or equal to 1 percent. The grade of the level spreader should be 0 percent to insure uniform spreading of storm runoff; (3) A 6-inch high gravel berm spreader should be placed across the level lip and should consist of washed crushed rock, 2 to 4-inch or 3/4-inch to 1 1/2-inch size; (4) The spreader length should be determined by estimating the flow expected from the 10-year, 24-hour storm, and selecting the appropriate length from the following table:

<u>Q. in CFS</u>	<u>Min. Length. in FEET</u>
0 - 0.10	15
0.10 - 0.20	20
0.20 - 0.30	30
0.30 - 0.40	40

(5) the depth of the spreader as measured from the lip should be at least 6-inches and it should be uniform across the entire length; (6) The slope of the undisturbed outlet should not exceed 20 percent.

**Maintenance:** The spreader should be inspected after every runoff event to insure that it is functioning correctly. The contractor should avoid the placement of any material on or prevent construction traffic across the structure. If the spreader is damaged by construction traffic, it should be immediately repaired.

Figure 3-20 LEVEL SPREADER





---

---

**CONTROL MEASURE: DIVERSION CHANNELS AND DITCHES.**

**Purpose:** Collects and conveys upslope contributing runoff prior to entering exposed soil areas and routes it around the construction site.

**Design Criteria/Specifications:** (1) Concentrated drainage flow entering the construction site should, whenever possible, either be conveyed around the areas of the site that are to be disturbed, or the existing drainage channel through the site should be left undisturbed. Off-site drainage flowing through a construction site **must** be discharged at its natural discharge location; (2) See Chapter 7, Collection and Conveyance Facilities, concerning open channel design. See also **Outlet Protection BMPs**; (3) Temporary on-site conveyance channels and ditches should be designed and constructed to accommodate the peak flow from a 10-year, 24-hour design storm event for the post-development condition without erosion, with 0.5 feet of freeboard; (4) Stabilization measures to prevent erosion of **outlets, adjacent stream banks, slopes, and downstream reaches** should be provided at the **outlets** of all pipes and channels.

---

---

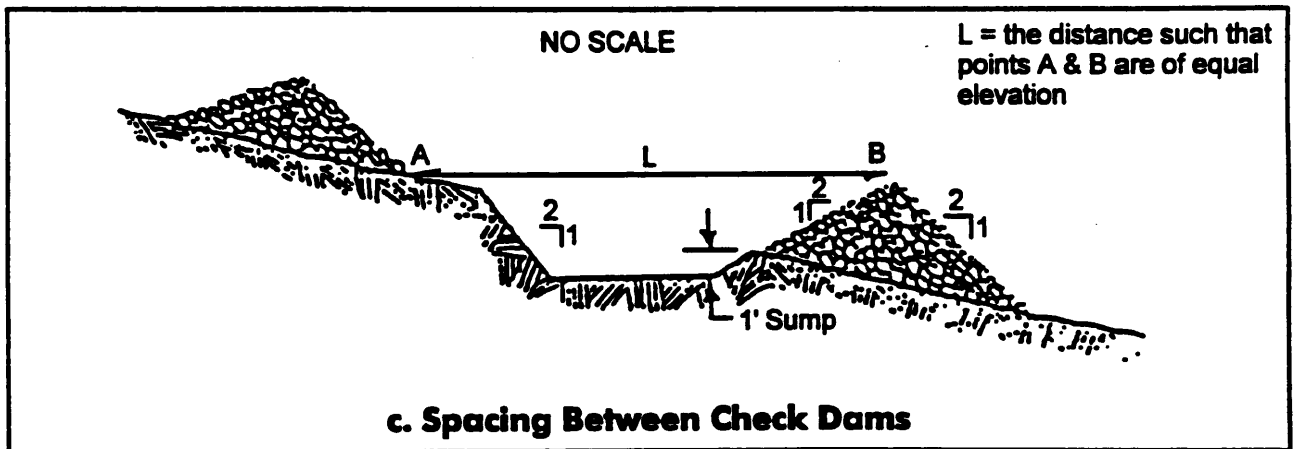
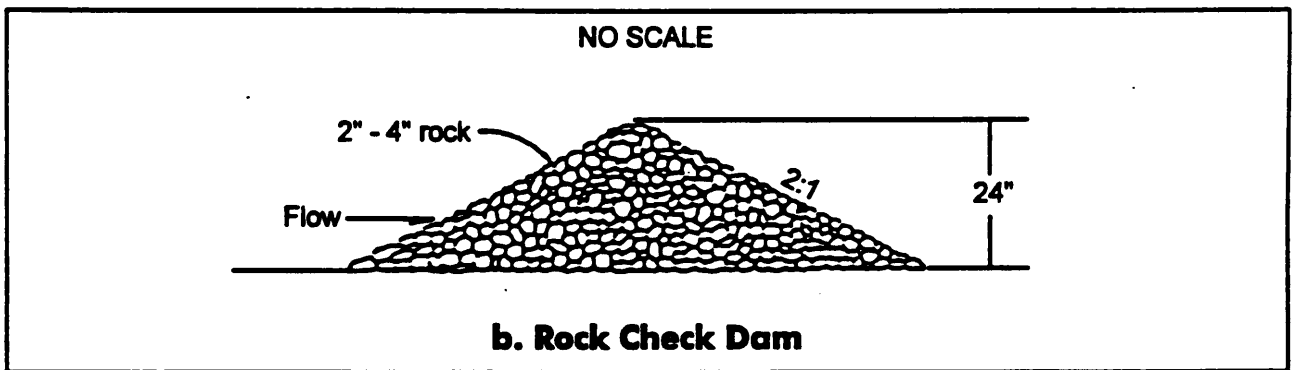
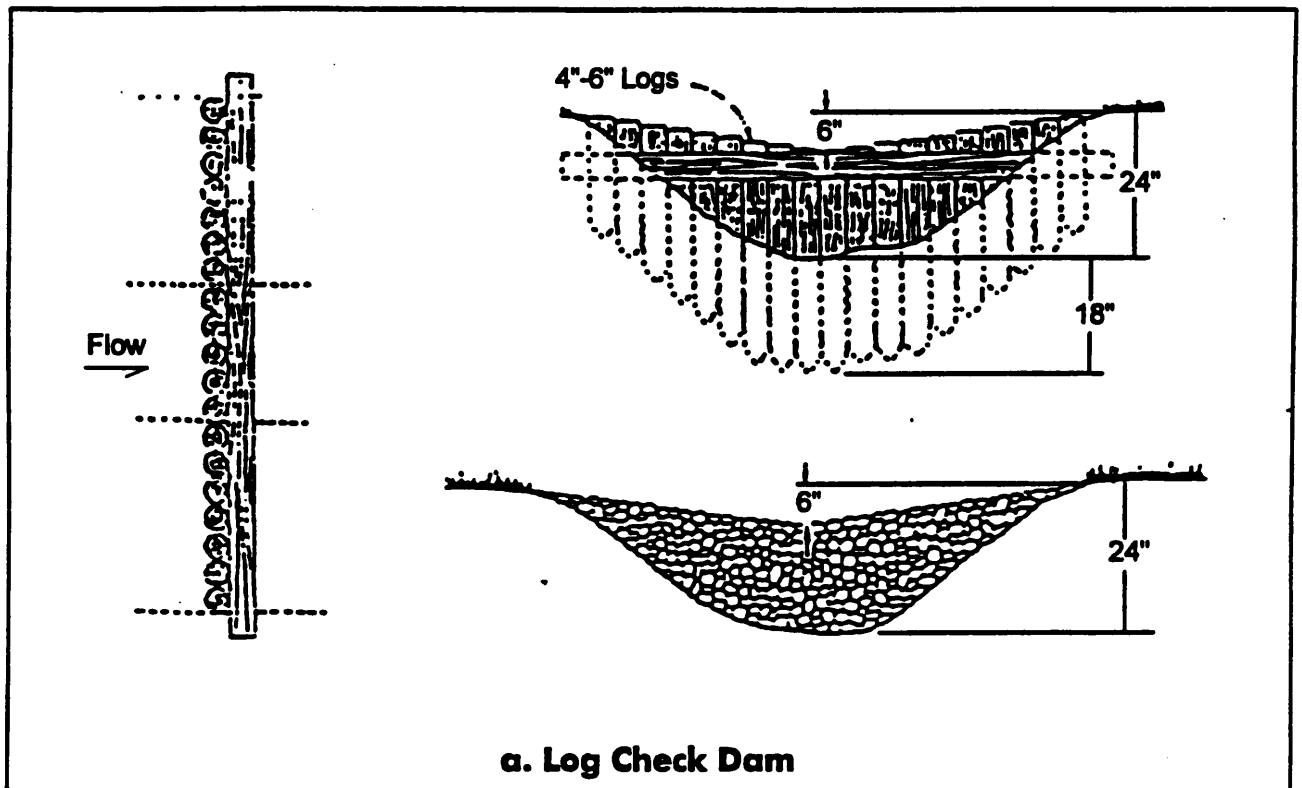
**CONTROL MEASURE: CHECK DAMS.**

**Purpose:** Reduces the velocity of concentrated flows, reducing erosion of the swale or ditch and slows water velocity to allow retention of sediments. Check dams are not permitted in streams unless approved by the Department of Fish and Wildlife.

**Design Criteria/Specifications:** (1) See Figure 3-21 for design features; (2) Check dams in association with sumps work more effectively at slowing flow and retaining sediment; (3) Check dams can be constructed of rock, logs or pea-gravel filled **sandbags**. A 1-foot deep sump should be provided immediately upstream of each check dam; (4) The maximum spacing between the dams should be such that the toe of the upstream dam is at the same elevation as the top of the downstream dam; (5) Rock check dams should be constructed of appropriately sized rock, such as rock spalls, 4-inch minus. The rock should be hand or machine placed (no dumping allowed) to achieve complete coverage of the ditch or swale and to ensure that the center of the dam crest is lower than the crest ends. The rock used should be large enough to stay in place given the expected design flow through the channel; (6) Log check dams should be constructed of 4 to 6-inch diameter logs. The logs should be embedded into the soil at least 18-inches. Removal of log check dams will result in more disturbance of the soil than will the removal of rock check dams. Consequently, extra care should be taken to stabilize the area when log dams are used in permanent ditches or swales; (7) In the case of grass-lined ditches and swales, check dams should be removed when the grass has matured sufficiently to protect the ditch or swale unless the slope of the swale is greater than 4%. The area beneath the check dams should be **seeded and mulched** immediately after dam removal.

**Maintenance:** Check dams should be monitored for performance and sediment accumulation during and after each runoff-producing storm event. Sediment should be removed when it reaches 1/3 the sump depth.

Figure 3-21 CHECK DAM



---

---

**CONTROL MEASURE: RESTRICT THE LENGTH OF TRENCH OPENED AT ANY ONE TIME.**

**Purpose:** Control the erosion of open trench bottoms by limiting the length of run, thus limiting the velocity of water flowing through the trench.

**Design Criteria/Specifications:** For trenches on a downslope of more than 5%, no more than 500-feet of trench should be opened at one time.

---

---

**CONTROL MEASURE: DIVERT SURFACE RUNOFF FROM ENTERING TRENCHES.** (See also **Interceptor Dike/Berm and Swale BMP**).

**Purpose:** Diverting surface runoff from entering open trenches will reduce the flow of water into the trenches and reduce the degree of erosion of trench bottoms.

**Design Criteria/Specifications:** Place excavated material from trenches on the uphill side of the trench when safety and space constraints allow. A note to this effect should be included on the ESC plan.

---

---

**CONTROL MEASURE: DISCHARGE DEWATERING DEVICES PROPERLY.**  
(See also Sediment Trap and Sediment Pond BMP).

**Design Criteria/Specifications:** Direct the discharge of dewatering devices from trenches or other areas so as not to adversely impact flowing streams, drainage systems or off-site property. Dewatering devices shall not discharge to sanitary sewers.

---

**CONTROL MEASURE: COMPOST FILTER BERM**

**Purpose:** Intercepts and detains sediment from disturbed areas during construction operations in order to prevent the sediment from leaving the site.

**Design Criteria/Specifications:** (1) Compost berms should be located down slope of disturbed areas where runoff may occur in the form of sheet runoff (2) Compost berms shall not be used in any channels or ditches. (3) Compost berms should not be used on slopes greater than 10%.

Compost shall conform to the following:

- a. Compost shall be stable, mature, decomposed organic solid waste that is the result of accelerated, aerobic biodegradation, and stabilization under controlled conditions. The result is a uniform dark, soil-like appearance.
- b. Compost maturity or stability is the point at which the aerobic biodegradation of the compost has slowed and oxygen consumption and carbon dioxide generation has dropped. Subsequent testing provides consistent results.
- c. 100 percent shall pass through a 1-inch sieve when tested in accordance with AASHTO Test Method T87 and T88 and not more than 30% passing through the 3/8-inch sieve by weight.
- d. The pH range shall be between 5.5 and 8.5 when tested in accordance with WSDOT test method 417
- e. Manufactured inert material (Plastic, concrete, ceramics, metal, etc.) shall be less than 1 percent on a dry weight or volume basis, whichever provides for the least amount of foreign material.
- f. Minimum organic matter shall be 30 percent on a dry weight basis as determined by loss on ignition. (LOI test)
- g. Compost shall score a number 5 or above on the Solvita Compost Maturity Test"

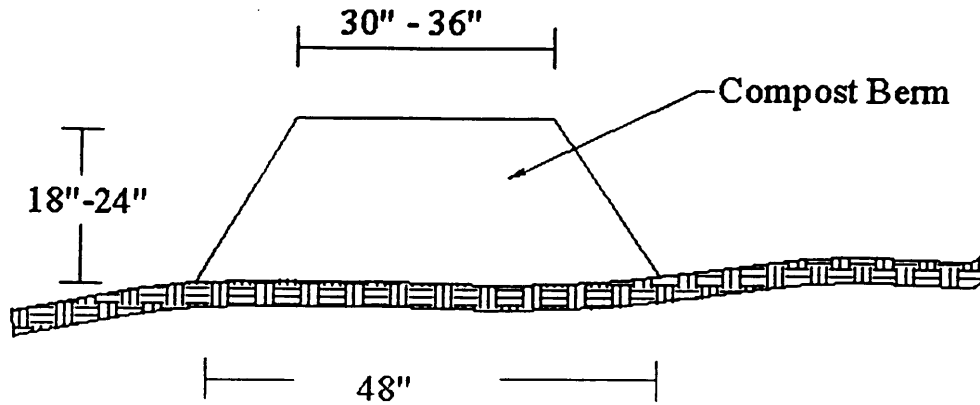
Construction shall conform to the following:

- a. Place berm parallel to the base of the slope, or around the perimeter of affected areas.
- b. Construct a 1 to 1.5 ft high by 2.5 to 3.0 ft wide berm as shown in figure 3-22 (bottom)
- c. For maximum water filtration or for steeper slopes (>5%), construct a 1.5 ft to 2 ft high trapezoidal berm that is 2.5 to 3.0 ft wide at the top and not less than 4 ft wide at the base. (Top of Figure 3-22)

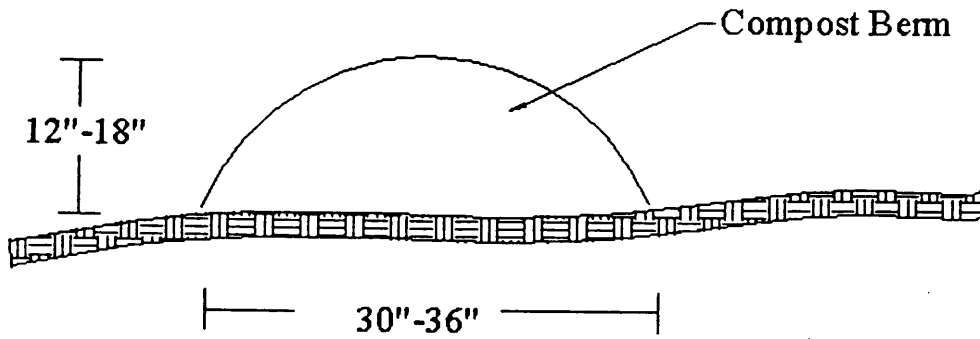
**Maintenance:** (1) Compost berms should be inspected immediately after each runoff-producing rainfall and at least daily during prolonged rainfall. Any required repairs should be made immediately; (2) Sediment should be removed when it reaches approximately one third the height of the berm (6 inch maximum), especially if heavy rains are expected; (3) Any sediment deposits remaining in place after the berm is no longer required should be dressed to conform with the existing grade, prepared, and seeded.



Figure 3B-22 Compost Berm



Compost Berm Steep Slope (5-10%) Applications (Not to Scale)



Compost Berm Shallow Slope (<5%) Applications (Not to Scale)



# CHAPTER 4

## GRADING



# CHAPTER 4

## GRADING

### CONTENTS

4.1	INTRODUCTION	4-1
4.2	APPLICABILITY	4-1
	4.2.1 PERMIT EXEMPTIONS	4-2
	4.2.2 ENGINEERED GRADING	4-3
4.3	SEPA REQUIREMENTS	4-3
4.4	REVIEW COORDINATION	4-4
4.5	FEES	4-5
4.6	PERMIT REQUIREMENTS	4-5
	4.6.1 CONSTRUCTION LIMITS	4-5
	4.6.2 CHANGED CONDITIONS, STOP WORK ORDER AND PERMIT REVOCATION	4-5
	4.6.3 ENGINEERS' NOTIFICATION OF NONCOMPLIANCE	4-6
	4.6.4 PERMIT TIME LIMIT	4-6
	4.6.5 INSPECTIONS	4-6
	4.6.6 COMPLETION OF WORK AND FINAL APPROVAL	4-6
4.7	GRADING STANDARDS	4-7
	4.7.1 SOILS ENGINEERING INVESTIGATION REPORT	4-7
	4.7.2 GEOTECHNICAL ENGINEERING INVESTIGATION REPORT	4-7
	4.7.3 EXCAVATIONS	4-8
	GENERAL	4-8
	SLOPE STEEPNESS	4-8
	4.7.4 FILLS AND EMBANKMENTS	4-8
	GENERAL	4-8
	PREPARATION OF GROUND	4-8
	FILL MATERIAL	4-8
	COMPACTION	4-9
	SLOPE	4-9
	STRUCTURES	4-9



4.7.5	SETBACKS	4-10
	GENERAL	4-10
	TOP OF CUT SLOPES	4-10
	TOE OF FILL SLOPES	4-10
	MODIFICATION OF SLOPE LOCATION	4-10
4.7.6	DRAINAGE AND TERRACING	4-11
	GENERAL	4-11
	TERRACE	4-11
	SUBSURFACE DRAINAGE	4-11
	DISPOSAL	4-11
	INTERCEPTOR DRAINS	4-11
4.7.7	IMPERVIOUS SURFACES	4-12
4.7.8	EROSION CONTROL	4-12
	APPLICANT'S RESPONSIBILITY	4-12
	EMERGENCY CONTACT PERSON	4-12
	SEALING THE SURFACE	4-13
	REVEGETATION	4-13
	<b><u>NOTICE OF GRADING OR FILLING</u></b>	4-14





# **GRADING**

## **4.1 INTRODUCTION**

These regulations establish minimum requirements for grading and earthwork construction including excavating and filling. They are intended to promote the general health, safety and welfare of the public and require the Applicant to follow sound land use and development procedures.

The purpose of this chapter is to mitigate, minimize or eliminate the impacts caused by grading activities on public or private property.

It is not the intent of these policies to make Kitsap County a guarantor or protector of public or private property in regard to land development activity.

## **4.2 APPLICABILITY**

A Site Development Activity Permit shall be required prior to the commencement of the following grading activities:

1. When grading activities exceed 150 cubic yards of earth, OR;
2. When grading activities will result in a temporary or permanent slope having a steepness exceeding 3 to 1 (3 feet horizontal to 1 foot vertical) and having a total slope height, measured vertically from toe of slope to top of slope, exceeding 5 feet, OR;
3. When grading activities include the construction of embankment berms which have the potential to impound water to a depth exceeding 2 feet and/or have a maximum volume exceeding 2500 cubic feet at maximum water surface depth, OR;
4. When grading activities will result in the diversion of existing drainage courses, both natural and man-made, from their natural point of entry or exit from the grading site, OR;
5. When grading activities will result in the creation of impervious or nearly impervious surfaces that are 5000 square feet or more in area, OR;
6. When grading activities involve the clearing or disturbance of 1 acre or more of land.

#### **4.2.1 PERMIT EXEMPTIONS**

The following grading activities shall not require the issuance of a Site Development Activity Permit:

1. Excavation for utilities, or for wells or tunnels allowed under separate permit by other agencies.
2. An excavation below finished grade for basements and footings of a building, retaining wall or other structure authorized by a valid building permit. This shall not exempt the placement of any fill material removed from such an excavation, and shall not exempt any excavation beyond the limits of the basement or footing excavations having an unsupported height greater than 5 feet after the completion of such a structure.
3. Agricultural crop management outside of critical drainage areas, limited to the preparation of soil by turning, discing, or other means endorsed by the Kitsap Conservation District.
4. Excavation for cemetery graves.
5. Disturbance of topsoil to a maximum depth of 12" confined to less than 1 acre of land clearing activity.
6. Solid waste disposal sites, wood waste fills, problem waste and demolition waste sites authorized pursuant to R.C.W. 70.95, and regulations presently enacted or as may be amended or as specifically approved by the Bremerton Kitsap County Health Department. Grading activities associated with said disposal activities shall not be exempt from the provisions of the Stormwater Management Ordinance.
7. Mining, quarrying, excavating, processing and/or stockpiling of rock, sand, gravel, aggregate or clay where established and provided by law, and a permit for said activity has been issued by the State of Washington or the Federal Government, provided such operations do not affect the lateral support or increase the stresses in or pressure upon any adjacent or contiguous land and the activities meet the minimum requirements of this ordinance.
8. Exploratory excavations under the direction of a qualified professional engineer.
9. Grading activities already approved by separate permit granted by any governing authority, provided that the activities meet the minimum requirements of this Ordinance.
10. Emergency sandbagging, diking, ditching, filling or similar work during or after periods of extreme weather conditions when done to protect life or property.

11. Maintenance work on public roads performed under the direction of Kitsap County or Washington State Department of Transportation personnel.

#### **4.2.2 ENGINEERED GRADING**

Grading activities, as well as all other site development-related activities, must comply with the requirements of this Manual regarding land clearing, the conveyance of surface runoff, and the quantity and quality control of surface runoff.

A grading plan and an erosion and sedimentation control plan, prepared by a professional engineer, shall be submitted to the Department of Public Works for review and approval of the following grading activities:

- o The displacement of 5000 or more cubic yards of material within the project site, OR;
- o The creation and/or displacement of less than 5000 cubic yards of material when the Director deems that engineering is appropriate.

In addition, a soils report and/or a geotechnical report may be required for certain site conditions or grading activities as described in this chapter.

A Performance Covenant or a performance bond and commercial liability insurance shall be provided as a minimum requirement prior to the issuance of a Site Development Activity Permit for engineered grading activities.

#### **4.3 SEPA REQUIREMENTS**

Unless the proposed grading has already been addressed in a SEPA (State Environmental Protection Act) Environmental Checklist submitted as part of a Land Use Application, a SEPA Environmental Checklist must be submitted at the time of application for a Site Development Activity Permit for grading, for the following proposed activities:

- o The displacement of 500 or more cubic yards of material.
- o Clearing or grading within or near streams, bodies of water, or other critical areas, as determined by the Kitsap County Department of Community Development (K.C.D.C.D.).

A SEPA Environmental Checklist will not be required when other ordinances specifically exempt the proposed activity from meeting SEPA requirements.

A final determination of whether or not a SEPA Environmental Checklist is required for a project will be made by the SEPA Coordinator for the Kitsap County Department of Community Development.

A Determination of Non-Significance (D.N.S.) or a final Environmental Impact Statement (F.E.I.S.) must be issued before the Site Development Activity Permit is issued. Provisions contained in the Determination of Non-Significance or the final Environmental Impact Statement shall be considered when approving the Site Development Activity Permit for grading, and the conditions of issuance of the permit shall not be less restrictive than the D.N.S. or the F.E.I.S.

The SEPA Environmental Checklist review may run concurrently with the application for the Site Development Activity Permit. Any questions or comments concerning the SEPA Environmental Checklist review should be addressed to the Kitsap County Department of Community Development.

#### **4.4 REVIEW COORDINATION**

When grading activities are proposed for a site and such activities are related to a project requiring land use approval from the Kitsap County Department of Community Development, a Site Development Activity Permit for the proposed grading activity will not be issued by Kitsap County until all land use permits and/or approvals are granted.

Conditions imposed by the Board of Commissioners, the Kitsap County Department of Community Development, or other governmental agencies affecting the Site Development Activity Permit for grading must be incorporated into the project's design and must be implemented prior to final approval of the project.

When development is intended or proposed on a site affected by issuance of a Site Development Activity Permit for grading, work allowed by issuance of that permit shall be subordinate to future site development conditions or requirements.

When grading on a parcel of land is proposed which is intended to facilitate the future development of a site, or which may limit the future use of the site, the County may at its own discretion require that a notice be recorded as a public record containing provisions which will include the nature and extent of the grading which has occurred on the parcel. The latest version of the form entitled "Notice of Grading or Filling" shall be used.

## **4.5 FEES**

Site Development Activity Permit fees are included in the Site Development Activity Fee Ordinance.

## **4.6 PERMIT REQUIREMENTS**

### **4.6.1 CONSTRUCTION LIMITS**

Prior to the commencement of permitted clearing and grading activities, clearing and grading limits must be clearly and visibly identified using staking and/or flagging. Under no circumstances may areas beyond the property boundaries be disturbed without the prior approval of the owners of those properties and without the issuance by Kitsap County of all necessary permits to work within these areas. Clearing limits may require inspection by the Department of Community Development and/or the Department of Public Works prior to commencement of site work activities.

### **4.6.2 CHANGED CONDITIONS, STOP WORK ORDER AND PERMIT REVOCATION**

Should the County become aware of conditions that invalidate the original design data used to obtain the Site Development Activity Permit or determine that the Applicant is not complying with the conditions of the Permit or approved plans, the County may revoke the original permit and/or order work stopped on the project. The County may require the Applicant to resubmit information or plans for review and approval and apply for a new Site Development Activity Permit.

The County may order all or part of a permitted work stopped for any period of time for any of the following reasons:

1. The Applicant fails to comply with the conditions of the permit.
2. The permit was granted on the basis of erroneous information submitted to the County by the Engineer or Applicant.
3. The weather or weather-created conditions cause off-site or downstream drainage, water quantity or water quality problems.
4. The work has become a hazard to life, endangers property or adversely affects the use or stability of a public way or drainage course.

#### **4.6.3 ENGINEERS' NOTIFICATION OF NONCOMPLIANCE**

If, in the course of fulfilling his/her responsibility under this chapter, the project engineer or any associated engineer finds the work is not being done in conformance with this chapter or with the conditions of permit approval or the approved Grading Plan, the discrepancies shall be reported immediately in writing to the person in charge of the grading work and to the Director. Recommendations for corrective measures, if necessary, shall be submitted.

#### **4.6.4 PERMIT TIME LIMIT**

A Site Development Activity Permit, for grading only, shall expire upon approved completion of all work, or 6 months from the date the permit was issued, whichever comes first. If the Applicant requests a time extension for the Site Development Activity Permit, the Director has the authority to grant or to deny such an extension request. In the event that work is not completed at the time of expiration of the permit, and the permit expiration date has not been extended by the Director, all work must cease and a new Site Development Activity Permit application must be submitted and approved prior to the resumption of work. Work not completed pursuant to the earlier permit will be reviewed in accordance with the most recent version of this Manual.

#### **4.6.5 INSPECTIONS**

The Kitsap County Department of Public Works, Construction Division, shall be called for inspection as follows:

- o After erosion and sedimentation control facilities are in place and prior to the commencement of grading operations.
- o After rough grading is completed.
- o For final inspection, following site stabilization.

#### **4.6.6 COMPLETION OF WORK AND FINAL APPROVAL**

Final approval of work and the release of performance bonds shall not take place until the following has been completed:

- o All work, including installation of all drainage facilities and their protective devices, and all erosion control measures, including permanent stabilization, have been completed in accordance with the final approved Grading Plan and the approved Erosion and Sedimentation Control Plan.
- o Final inspection and approval of work by the County.

- o Any required final reports and statements of approval from the project engineer have been submitted to and approved by the County.
- o Any required easements related to operation and maintenance of drainage facilities have been recorded.

## **4.7 GRADING STANDARDS**

The following grading standards are intended as MINIMUM requirements for grading in Kitsap County. If circumstances create a hazard to life, endanger or adversely affect the use or stability of a public way, adjacent property, critical area, or drainage course, the County may impose additional or more stringent requirements to fulfill the intent of the Stormwater Management Ordinance.

### **4.7.1 SOILS ENGINEERING INVESTIGATION REPORT**

When the proposed work involves soils which may be excessively erodible or which may have limited compaction capability, due to the moisture content or the potential unsuitable nature of the material itself, or the Kitsap County Building Official requires a soils investigation report prepared by a qualified professional engineer for a proposed structure to be placed on fill material, the County shall require a soils engineering investigation report prepared by a soils engineer. This report shall include, as a minimum, 1) data regarding the nature, distribution and strength of existing soils, 2) conclusions and recommendations for grading procedures and/or erosion control measures, 3) design criteria for corrective measures when necessary, 4) opinions and recommendations covering a site's adequacy for further development, and 5) allowable bearing pressure, if applicable. Recommendations in the report shall be incorporated in the proposed plans or specifications.

### **4.7.2 GEOTECHNICAL ENGINEERING INVESTIGATION REPORT**

When on-site conditions or the proposed work involves slide prone or unstable soils, or when proposed slopes do not meet the minimum design standards described in this Manual, or when existing slopes steeper than 30% are to be cleared, graded or otherwise disturbed, the County shall require a geotechnical engineering investigation report prepared by a qualified professional engineer. This report shall include, as a minimum, 1) data regarding the effects of groundwater interception and infiltration, seepage, potential slip planes, and changes in soil bearing strength of existing soils, 2) conclusions and recommendations for grading procedures and design criteria for corrective measures when necessary, 3) recommendations regarding erosion control procedures, and 4) opinions and recommendations covering a site's adequacy for further development, and 5) allowable bearing pressure, if applicable. Recommendations in the report shall be incorporated in the proposed plans or specifications

#### **4.7.3 EXCAVATIONS**

##### **GENERAL**

Unless otherwise recommended in an approved soils engineering investigation report and/or geotechnical engineering investigation report, all excavations must comply with the following minimum requirements.

##### **SLOPE STEEPNESS**

Excavated slope faces shall be no steeper than is safe for the intended use and shall not be steeper than 2 horizontal to 1 vertical (2:1).

#### **4.7.4 FILLS AND EMBANKMENTS**

##### **GENERAL**

Unless otherwise recommended in an approved soils engineering investigation report or geotechnical engineering investigation report, all fills and embankments must comply with the following minimum requirements.

##### **PREPARATION OF GROUND**

Fill slopes shall not be constructed on natural slopes steeper than 2 horizontal to 1 vertical (2:1). The ground surface shall be prepared to receive fill by removing vegetation, noncomplying fill, topsoil and other unsuitable materials, scarifying the surface to provide a bond with the new fill and, where natural slopes are steeper than 3 horizontal to 1 vertical (3:1) and the height is greater than 5 feet, by benching into sound bedrock, glacial till or other competent material as determined by a soils engineer. The bench under the toe of fill on a slope steeper than 3 horizontal to 1 vertical (3:1) shall be at least 10 feet wide. The area beyond the toe of fill shall be sloped for sheet overflow or a paved drain shall be provided. When fill steeper than 3:1 and higher than 5' is to be placed over an excavation, the soils engineer and/or geotechnical engineer shall certify that the foundation is suitable for the fill.

##### **FILL MATERIAL**

Detrimental amounts of organic material shall not be permitted in fills. Except as permitted by the Director, no rock or similar irreducible material with a maximum dimension greater than 12 inches shall be buried or placed in fills.

**EXCEPTION:** The Director may permit placement of larger rock or similar irreducible material i.e. concrete, etc. when a soils engineer properly devises a method of placement



and continuously inspects its placement and approves the fill stability. The following conditions shall also apply:

- A. Prior to issuance of a Site Development Activity Permit for grading, potential rock disposal areas shall be delineated on the grading plan.
- B. Rock sizes greater than 12 inches in maximum dimension shall be 10 feet or more below grade, measured vertically.
- C. Rocks shall be placed so as to assure filling of all voids with well-graded soil.

### COMPACTION

All fills and embankments shall be compacted to a minimum of 90 percent of maximum dry density, as determined by the tests described in the WSDOT/APWA Standard Specifications for Road, Bridge and Municipal Construction. Embankments constructed as berms for the holding back of water shall be compacted to a minimum of 95 percent of maximum dry density. Soil density shall be determined utilizing the Modified Proctor method. Fills on sites of proposed structures shall be compacted as directed by the Kitsap County Building Official in accordance with the Uniform Building Code. Where the Director requires testing of the compaction of soils outside public right-of-way, compaction shall be tested by an independent soils testing lab at the owner's expense.

### SLOPE

The slope of fill surfaces shall be no steeper than is safe for the intended use and shall be no steeper than 2 horizontal to 1 vertical (2:1).

### STRUCTURES

Fills which are intended to support structures shall be constructed in conformance with the requirements of the latest edition of the Uniform Building Code, as adopted by Kitsap County, and an assignment of allowable soil-bearing pressures will be under the jurisdiction of the Kitsap County Building Official in accordance with the U.B.C. When fill is proposed over an area that the County deems to be a potential building site, and the Applicant does not state an intent to construct buildings on the fill area, the County may at its own discretion require that a notice be recorded as a public record containing provisions which will include the nature and extent of the grading which has occurred on the parcel. The latest version of the form entitled "Notice of Grading or Filling" shall be used.

## **4.7.5 SETBACKS**

### **GENERAL**

Excavation and fill slopes shall be set back from site boundaries in accordance with this section. Setback dimensions shall be horizontal distances measured perpendicular to the site boundary.

### **TOP OF CUT SLOPES**

The top of cut slopes shall not be made nearer to a site boundary line than one fifth (1/5) of the vertical height of cut with a minimum of 2 feet and a maximum of 10 feet. The setback may need to be increased for any required interceptor drains.

### **TOE OF FILL SLOPES**

The toe of fill slopes shall be made not nearer to the site boundary line than one half (1/2) the height of the slope with a minimum of 5 feet and a maximum of 20 feet. Where a fill slope is to be located near the site boundary and the adjacent off-site property is developed, special precautions shall be incorporated in the work as the Director deems necessary to protect the adjoining property from damage as a result of such grading. These precautions may include but are not limited to:

1. Additional setbacks.
2. Provision for retaining or slough walls.
3. Mechanical or chemical treatment of the fill slope surface to minimize erosion.
4. Provisions for the control of surface waters.

### **MODIFICATION OF SLOPE LOCATION**

The Director may approve or require alternate setbacks and may require an investigation and recommendation by a qualified engineer to demonstrate that the intent of this section has been satisfied.

## **4.7.6 DRAINAGE AND TERRACING**

### **GENERAL**

Unless otherwise indicated on the approved grading plan, drainage facilities and terracing shall conform to the provisions of this chapter for cut or fill slopes steeper than 3 horizontal to 1 vertical (3:1).

### **TERRACE**

Terraces at least 6 feet in width shall be established at not more than 30-foot vertical intervals on all cut or fill slopes to control surface drainage and sloughing except that where only one terrace is required, it shall be at mid-height. For 3:1 or steeper cut or fill slopes greater than 60 feet and up to 120 feet in vertical height, one terrace approximately mid-height shall be 12 feet in width. Terrace widths and spacing for cut and fill slopes greater than 120 feet in height shall be designed by a qualified geotechnical engineer and approved by the Director. Suitable access shall be provided to permit proper cleaning and maintenance of the terraces.

A single run of swale or ditch shall not collect runoff from a tributary area exceeding 13,500 square feet (projected) without discharging into a down drain.

### **SUBSURFACE DRAINAGE**

Cut and fill slopes shall be provided with subsurface drainage as necessary for stability.

### **DISPOSAL**

All drainage facilities shall be designed to carry waters to the nearest practicable drainage way approved by the Director or other appropriate jurisdiction as a safe place to deposit such waters. Erosion of ground in the area of discharge shall be prevented by installation of non-erosive downdrains or other devices.

Building pads shall have a drainage gradient of 2 percent (2%) toward approved drainage facilities, unless waived by the Director.

### **INTERCEPTOR DRAINS**

Paved interceptor drains shall be installed along the top of all graded slopes where the contributing drainage area uphill from the slope has a drainage path greater than 40 feet measured horizontally. Interceptor drains shall be paved with a minimum of 3 inches of concrete or gunite and reinforced. They shall have a minimum depth of 12 inches and a

minimum paved with of 30 inches measured horizontally across the drain. The slope of drain shall be approved by the Director.

#### **4.7.7 IMPERVIOUS SURFACES**

In the event that impervious or nearly impervious surfaces are proposed that equal 5000 square feet or more, or 1 acre or more of land area is to be disturbed, the Site Development Activity Permit application shall include an engineered drainage plan and drainage report, as described in Chapter 2, Submittal Requirements, and shall comply with the quantity control requirements of Chapter 5, Stormwater Quantity Control Facilities, as well as the runoff quality control requirements of Chapter 6, Stormwater Quality Control Facilities. Compacted gravel, such as crushed rock compacted to 95 percent maximum dry density, shall be considered a nearly impervious surface.

#### **4.7.8 EROSION CONTROL**

An application for a Site Development Activity Permit for grading shall include an Erosion and Sedimentation Control Plan. This plan shall meet the requirements of Chapter 2, Submittal Requirements, and shall conform to the standards for erosion and sedimentation control included in Chapter 3, Erosion and Sedimentation Control.

#### **APPLICANT'S RESPONSIBILITY**

Temporary erosion and sedimentation control facilities shall be installed prior to any clearing and/or grading taking place. The Applicant is responsible at all times for the installation and maintenance of erosion and sedimentation control facilities.

#### **EMERGENCY CONTACT PERSON**

An emergency contact person having the means and the authority to institute emergency erosion and sedimentation control measures shall be available at all times until construction is completed, on a 24 hour per day basis. The name, address and 24 hour telephone number(s) for the emergency contact person shall be listed with the Kitsap County Department of Public Works, Construction Division. In the event that the County becomes aware of an emergency condition on the project site and is unable to contact the designated emergency contact person, or deems that the response to the emergency situation is inadequate, the County may enter the project site and perform any emergency work deemed necessary to protect life and limb, property, or adjacent public ways, critical areas or drainage courses. The project owner will be required to reimburse the County for all related costs incurred by the County for such emergency work.

### **SEALING THE SURFACE**

At the end of each day's work, the contractor must grade all areas to drain, and seal the surface using an acceptable means of compaction.

### **REVEGETATION**

Unless the approved plan provides otherwise, all cleared areas shall be seeded as soon as possible, or receive some other acceptable surface stabilization treatment in accordance with Chapter 3, Erosion and Sedimentation Control.

NOTICE OF GRADING OR FILLING

THIS NOTICE made this \_\_\_\_ day of \_\_\_\_\_, 19 \_\_\_, by KITSAP COUNTY, by and through the Kitsap County Department of Public Works;

WHEREAS, \_\_\_\_\_, is the owner or contract purchaser of certain piece of property located in Kitsap County, State of Washington, and described as follows:

AND,

WHEREAS, KITSAP COUNTY, by and through the Department of Public Works, has issued a Site Development Activity Permit for grading or filling for a project on the above-noted parcel of property; and whereas the approved plans are on file in the office of the Kitsap County Department of Public Works, at 614 Division Street, Port Orchard, Washington;

NOW, THEREFORE, the public is hereby notified that grading or filling may occur on the above-described property and said activity may limit the use of the property for development purposes. Prospective purchasers may wish to consult County records and requirements before purchasing said property.

OWNER OR OWNER'S AGENT	Address
City, State, Zip	

**STATE OF WASHINGTON**

} ss

County of Kitsap

On this day personally appeared before me \_\_\_\_\_, to me known to be the individual or individuals, described in and who executed the within and foregoing instrument and acknowledged that he (she or they) signed the same in a free and voluntary act, for the uses and purposes therein mentioned.

GIVEN under my hand an official seal this \_\_\_ day of \_\_\_\_\_, 19\_\_\_.

\_\_\_\_\_  
**NOTARY PUBLIC in and for the State**  
of Washington, residing at  
\_\_\_\_\_

Note: This notice may be recorded as a courtesy only; no guarantee of recording is made or implied nor is this notice intended to substitute for actual physical inspection of any real property.

## CHAPTER 5

# STORMWATER QUANTITY CONTROL FACILITIES





# CHAPTER 5

## STORMWATER QUANTITY CONTROL FACILITIES

### TABLE OF CONTENTS

5.1	GENERAL REQUIREMENTS	5-1
5.1.1	PURPOSE AND SCOPE	5-1
5.1.2	RUNOFF CONTROL	5-1
	PEAK RATE CONTROL	5-1
	STREAMBANK EROSION CONTROL	5-1
	VOLUME CONTROL	5-2
5.1.3	CLOSED DEPRESSIONS	5-2
	MINIMUM REQUIREMENTS	5-2
5.1.4	EXEMPTIONS FROM RUNOFF CONTROL REQUIREMENTS	5-3
5.2	HYDROLOGY AND DESIGN STRATEGIES	5-4
5.2.1	COMPUTATION METHODS	5-4
	HYDROGRAPH ANALYSIS	5-4
	LEVEL-POOL ROUTING	5-5
5.2.2	BASIC RUNOFF PARAMETERS	5-5
	PRECIPITATION	5-5
	CURVE NUMBERS	5-13
	TIME OF CONCENTRATION	5-16
5.2.3	DESIGN STRATEGIES	5-18
	DRAINAGE BASIN DELINEATION	5-19
	OFF-SITE CONTRIBUTING RUNOFF	5-19
	BYPASS AREAS	5-19
	CORRECTION FACTORS	5-20
5.3	FACILITY DESIGN REQUIREMENTS	5-20
5.3.1	PONDS	5-20
	SITE CONSTRAINTS	5-22
	POND GEOMETRICS	5-22
	SETBACKS	5-25
	OVERFLOW	5-25
	FENCING	5-27
	SIGNING	5-27
	BERM EMBANKMENT/SLOPE STABILIZATION	5-30
	ACCESS	5-30



5.3.2	PARKING LOT PONDS	5-32
5.3.3	DETENTION TANKS AND VAULTS	5-34
	GENERAL DESIGN CRITERIA	5-37
	MATERIALS & STRUCTURAL STABILITY	5-37
	ACCESS	5-38
5.3.4	CONTROL STRUCTURES	5-41
	CONTROL STRUCTURE DESIGN CRITERIA	5-41
	RECTANGULAR NOTCHED, SHARP CRESTED WEIR	5-45
	V-NOTCH, SHARP CRESTED WEIR	5-45
5.3.5	RETENTION FACILITIES	5-46
	SOILS IDENTIFICATION AND DETERMINATION OF	
	INFILTRATION RATE	5-46
	DESIGN CRITERIA FOR INFILTRATION TRENCHES AND PONDS	5-47
	RETENTION PONDS	5-48
	INFILTRATION TRENCHES	5-48
5.3.6	INDIVIDUAL DOWNSPOUT INFILTRATION SYSTEMS	5-49



## FIGURES & TABLES

<u>FIGURE</u>	<u>TITLE</u>	<u>PAGE</u>
FIGURE 5-1	ISOPLUVIAL MAP - 2 YR., 24 HR	5-6
FIGURE 5-2	" " - 5 YR., 24 HR.	5-7
FIGURE 5-3	" " - 10 YR., 24 HR.	5-8
FIGURE 5-4	" " - 25 YR., 24 HR.	5-9
FIGURE 5-5	" " - 50 YR., 24 HR.	5-10
FIGURE 5-6	" " - 100 YR., 24 HR.	5-11
FIGURE 5-7	" " - 100 YR., 7 DAY	5-12
FIGURE 5-8	VOLUME CORRECTION FACTOR	5-21
FIGURE 5-9	DEBRIS BARRIER DETAIL	5-23
FIGURE 5-10	GRAVEL FILTER WINDOW DETAIL	5-24
FIGURE 5-11	SECONDARY RISER STACK	5-26
FIGURE 5-12	EMERGENCY OVERFLOW SPILLWAY WEIR SECTION	5-28
FIGURE 5-13	POND SIGN DESIGN	5-29
FIGURE 5-14	TEXTURAL TRIANGLE (USDA)	5-31
FIGURE 5-15	BOLLARDS	5-33
FIGURE 5-16	DETENTION TANK DETAIL	5-35
FIGURE 5-17	DETENTION VAULT DETAIL	5-36
FIGURE 5-18	DETENTION TANK ACCESS RISER	5-39
FIGURE 5-19	SOLID LOCKING LID	5-40
FIGURE 5-20	ORIFICE LOCATION - TEE RISER	5-42
FIGURE 5-21	ORIFICE LOCATION - BAFFLE RISER	5-43
FIGURE 5-22	TEE SECTION WITH NOTCH WEIR & BAFFLE	5-44
FIGURE 5-23	TYPE 2 CATCH BASIN SUMP - INFILTRATION TRENCH	5-50
FIGURE 5-24	OBSERVATION WELL	5-51
FIGURE 5-25	INDIVIDUAL DOWNSPOUT INFILTRATION SYSTEM STANDARD DESIGN	5-52
FIGURE 5-26	OVERFLOW DEVICES	5-55

---

<u>TABLE</u>	<u>TITLE</u>	<u>PAGE</u>
TABLE 5-1	HYDROLOGIC SOIL GROUP	5-14
TABLE 5-2	MODIFIED CURVE NUMBERS	5-15
TABLE 5-3	MANNING'S COEFFICIENTS/"K" FACTORS	5-17
TABLE 5-4	SOIL INFILTRATION RATES BASED ON TEXTURAL ANALYSIS	5-48
TABLE 5-5	INDIVIDUAL DOWNSPOUT INFILTRATION SIZING CHART	5-53



# **STORMWATER QUANTITY CONTROL FACILITIES**

## **5.1 GENERAL REQUIREMENTS**

### **5.1.1 PURPOSE AND SCOPE**

This chapter presents Kitsap County policy concerning the control of runoff from development sites. The scope of this chapter includes the following:

1. Methods for estimating the peak flow rates and volumes of surface water runoff and input data required.
2. Strategies to follow in completing a hydrologic analysis and the design of runoff quantity control facilities.
3. Design criteria and specifications for the construction of runoff quantity control facilities.

### **5.1.2 RUNOFF CONTROL**

When land development activity takes place in Kitsap County, any increases in surface runoff resulting from development activity must be controlled so that the peak rates and volumes of runoff leaving the post-development site do not exceed the capacity of receiving drainage conveyance facilities; do not increase the potential for streambank erosion; and do not add significant volume to an off-site closed depression. On-site runoff quantity control facilities must be provided to limit such peak runoff rates and volumes as outlined below.

#### **PEAK RATE CONTROL**

The post-development peak stormwater discharge rates from the development site for the 2, 10 and 100-year, 24-hour duration storm events shall at no time exceed the pre-development peak stormwater runoff rates for the same design storm event, except as expressly permitted by the Stormwater Management Ordinance. Additionally, the Director may require that runoff from a development site be controlled for additional design storm events.

#### **STREAMBANK EROSION CONTROL**

One primary objective in controlling the peak rate of runoff from a project site is to assure that, for a specific storm event, stormwater flowing downstream does not exceed the capacity of existing drainage conveyance structures. However, runoff quantity control is also necessary in order to prevent erosion of channels and adverse impact to habitats downstream.

Downstream open channels tend to be most impacted by an increase in the frequency and duration of "bank full" flow conditions during less intense but more frequent storm events. Stormwater detention facilities have the potential to create just such a condition. These facilities increase the frequency that flows will be discharged at design peak flow rates during lesser storm events and prolong the period during which flows are being released at the peak rate (due to the increased volume of runoff). As a result, downstream channels will experience "bank full" conditions more frequently and for significantly longer periods of time than before development. Since nothing can be done (aside from on-site stormwater retention) to reduce the volume of runoff and the resulting increase in the duration of peak downstream flow, detention systems must be designed so that, during lesser storm events, the release rate is lowered to less than "bank full" flow rates. Current available research indicates that the pre-development peak runoff rate from a 2-year, 24-hour storm represents "bank full" downstream conditions.

Where stormwater directly or indirectly discharges to open channels or streams, streambank erosion protection is required. The post-development peak stormwater discharge rate from a development site for the 2-year, 24-hour duration storm event shall not exceed fifty percent (50%) of the pre-development peak runoff rate for the same design storm event. The Director may require that runoff from a development site be controlled for additional design storm events.

## VOLUME CONTROL

In some cases, the project engineer and/or the Director may determine that rate control from the developed site will not adequately protect downstream properties due to inadequate capacity in the receiving drainage course or due to the existence of a receiving closed depression. In such cases, developed runoff may be retained on-site in an infiltration facility so as to avoid discharge to downstream properties. Where retention facilities are required, the design storms shall be the 100-year, 24-hour duration and the 100-year, 7-day duration storm events. Specific design criteria for retention facilities is given in this chapter.

### **5.1.3 CLOSED DEPRESSIONS**

Closed depressions are low lying areas which have no, or such a limited, surface outlet that in most storm events the area acts as a retention basin, holding water for infiltration into the ground or evaporation into the air. By their nature, closed depressions may contain wetlands which will require projects to meet the requirements of applicable sensitive areas rules and ordinances.

## MINIMUM REQUIREMENTS

Closed depressions shall be analyzed using hydrograph routing methods. Infiltration shall be addressed where appropriate. If a proposed project will discharge runoff to an existing closed depression that has greater than 5,000 square feet of water surface area at overflow elevation, the following requirements must be met:



**CASE 1:**

The pre-development 100-year, 7-day and 24-hour duration design storms from the drainage basin tributary to the closed depression are routed into the closed depression using only infiltration as outflow. If the design storms do not overflow the closed depression, no runoff may leave the site for the same storm events following development of a proposed project. This may be accomplished by excavating additional volume in the closed depression subject to all applicable requirements. If a portion of the depression is located off of the project site, impacts to adjacent properties shall be evaluated.

**CASE 2:**

The pre-development 100-year, 7-day and 24-hour duration design storm events from the drainage basin tributary to the closed depression are routed to the closed depression using only infiltration as outflow, and overflow occurs. The closed depression shall then be analyzed as a detention/infiltration pond. The required performance, therefore, shall not exceed the pre-development runoff rates for 50% of the 2-year and 100% of the 10-year; 100-year, 24-hour duration; and 100-year, 7-day duration design storms. This will require that a control structure, emergency overflow spillway, access road, and other applicable design criteria be met. If the facility will be maintained by Kitsap County, the closed depression shall be placed in a dedicated tract. If the facility will be privately maintained, the tract shall be located within a drainage easement. If a portion of the depression is located off of the project site, impacts to adjacent properties shall be evaluated.

**CASE 3:**

When a proposed project is contributory to a closed depression located off-site, the volume of runoff discharged may not be increased for the 2, 10 and 100-year, 24-hour duration, and the 100-year, 7-day duration storm events. The exception to this requirement is in the case where discharge would not result in an increase in water surface elevation of greater than 0.01-foot for the 100-year storm events.

**5.1.4 EXEMPTIONS FROM RUNOFF CONTROL REQUIREMENTS**

1. Residential lots 2.5 acres or larger are exempt from the provisions of this chapter unless otherwise determined by the Director. Cases where the exemption does not apply includes, but is not limited to, sites within or adjacent to critical areas or watersheds, steep or unstable slopes, or where the cumulative impacts of development warrant. Site development activities taking place on individual lots of 2.5 acres or larger, which meet the definition of a Major Development, are not exempt from the requirements of this chapter. Proposed access roadways serving residential lots larger than 2.5 acres which meet the definition of a Major Development are not exempt from the requirements of this chapter.
2. On-site peak rate runoff control will generally NOT be required for projects that propose to construct less than 5000 square feet of new impervious surface on an

individual parcel. However, proposed projects located in proximity to critical drainage areas shall not qualify for this exemption if it is determined by the Director that more strict peak runoff rate or runoff volume controls are warranted. Also, if there is a recorded condition of a plat, short plat or large lot subdivision approval that requires peak rate runoff control for an individual lot, such as an individual downspout infiltration system, that parcel will not qualify for this exemption.

3. Land developments shall provide stormwater quantity control facilities designed to meet, as a minimum performance standard, the requirements of this Section, except in the following circumstances:
  - a. The development site discharges directly into Puget Sound, or directly into the tidally influenced areas of rivers and streams discharging into Puget Sound, where runoff quantity control is not required by other governmental agencies and streambank or shoreline erosion will not occur.
  - b. The development site discharges to a regional stormwater facility approved by the Director to receive the developed site runoff.
  - c. The development site discharges to a receiving body of water (lake, wetland, etc.) where it can be demonstrated by the Applicant, to the satisfaction of the Director, that stormwater quantity control is not warranted.

Projects qualifying for direct discharge will be required to provide water quality facilities, as described in Chapter 6.

## **5.2 HYDROLOGY AND DESIGN STRATEGIES**

### **5.2.1 COMPUTATION METHODS**

#### **HYDROGRAPH ANALYSIS**

All runoff quantity control facilities must be designed using hydrograph analysis methods for estimating storm runoff rates. Runoff control storage facilities must be designed using appropriate storage routing methods.

In the Puget Sound area, the two most commonly accepted hydrograph methods for estimating storm runoff are the Soil Conservation Service (SCS) TR-55 Hydrograph Method and the Santa Barbara Urban Hydrograph Method.

The SCS TR-20 Hydrograph Method has been in common use in this region for a number of years and is familiar to most engineers. However, it is limited to larger basins and is not permitted for the design of runoff control facilities in Kitsap County for basins smaller than 100 acres.

The Santa Barbara Urban Hydrograph Method is permitted for the design of runoff control facilities in Kitsap County for any size basin. A detailed explanation of this method is covered in the D.O.E. Stormwater Manual or King County Surface Water Design Manual.

Commercial software is presently available for use by engineers for using either of these methods. However, it should be understood that when a computer program is used in a design, the County is limited to only reviewing the appropriateness of the computation procedure and the input parameters used. When submitting computations, the engineer must thoroughly document all data input. It will be expected that the design engineer have a complete understanding of the processes being performed by any software routine.

### LEVEL-POOL ROUTING

The storage capacity of detention, retention and infiltration systems must be designed using a level pool routing technique.

SCS Technical Release 55 is appropriate for generating stormwater runoff hydrographs. However, the methods followed in Release 55 for estimating detention storage volumes are NOT acceptable to Kitsap County in the design of detention facilities.

The Washington State Department of Ecology's Stormwater Management Manual for the Puget Sound Basin ("Technical Manual") includes a description of a level pool routing technique which is widely accepted by various municipalities in the Puget Sound area. Although it tends to be more difficult to compute manually than the SCS storage volume method, it tends to result in a much more accurate estimation of storage requirements.

### **5.2.2 BASIC RUNOFF PARAMETERS**

This manual does not attempt to provide a detailed description of the SCS TR-20 Hydrograph Method, Santa Barbara Urban Hydrograph Method or level pool routing Methods, as detailed descriptions of these methods are readily available to the design engineer from the Department of Ecology or the Soil Conservation Service. Instead, the following comments are offered to assist the design engineer in implementing these methods.

### PRECIPITATION

The isopluvial maps for Kitsap County for the 2, 5, 10, 25, 50 and 100-year recurrence interval, 24-hour duration storm events are shown in Figures 5-1 to 5-6. They were taken

from NOAA Atlas 2, "Precipitation - Frequency Atlas of the Western United States, Volume IX-Washington." The 100-year, 7-day isopluvial map shown on Figure 5-7 was taken from the U.S. Weather Bureau Technical Paper No. 49, "Two-to-Ten Day Precipitation for Return Periods 2 to 100 years in the Contiguous United States".

Figure 5-1 ISOPLUVIAL MAP - 2 YEAR

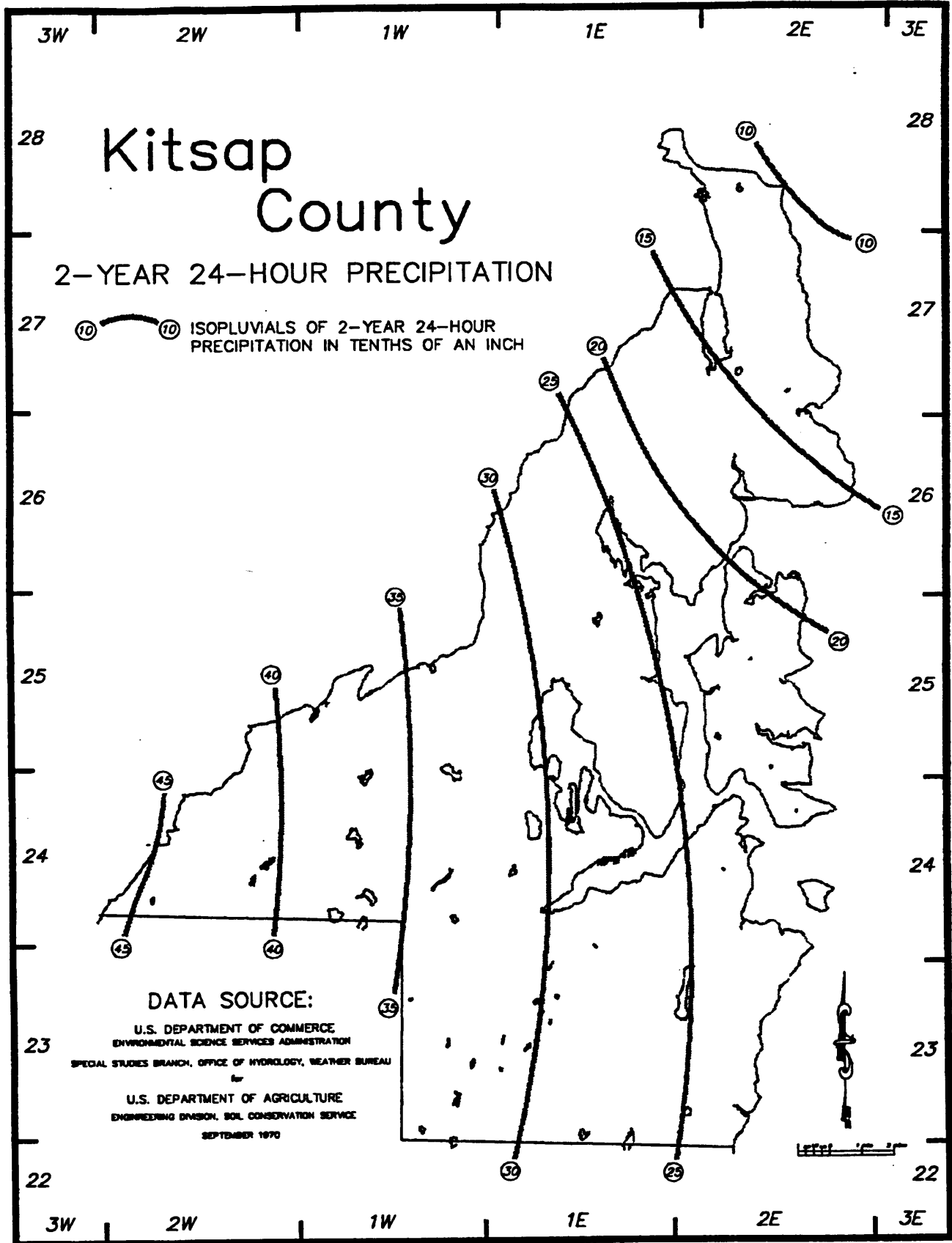


Figure 5-2 ISOPLUVIAL MAP - 5 YEAR

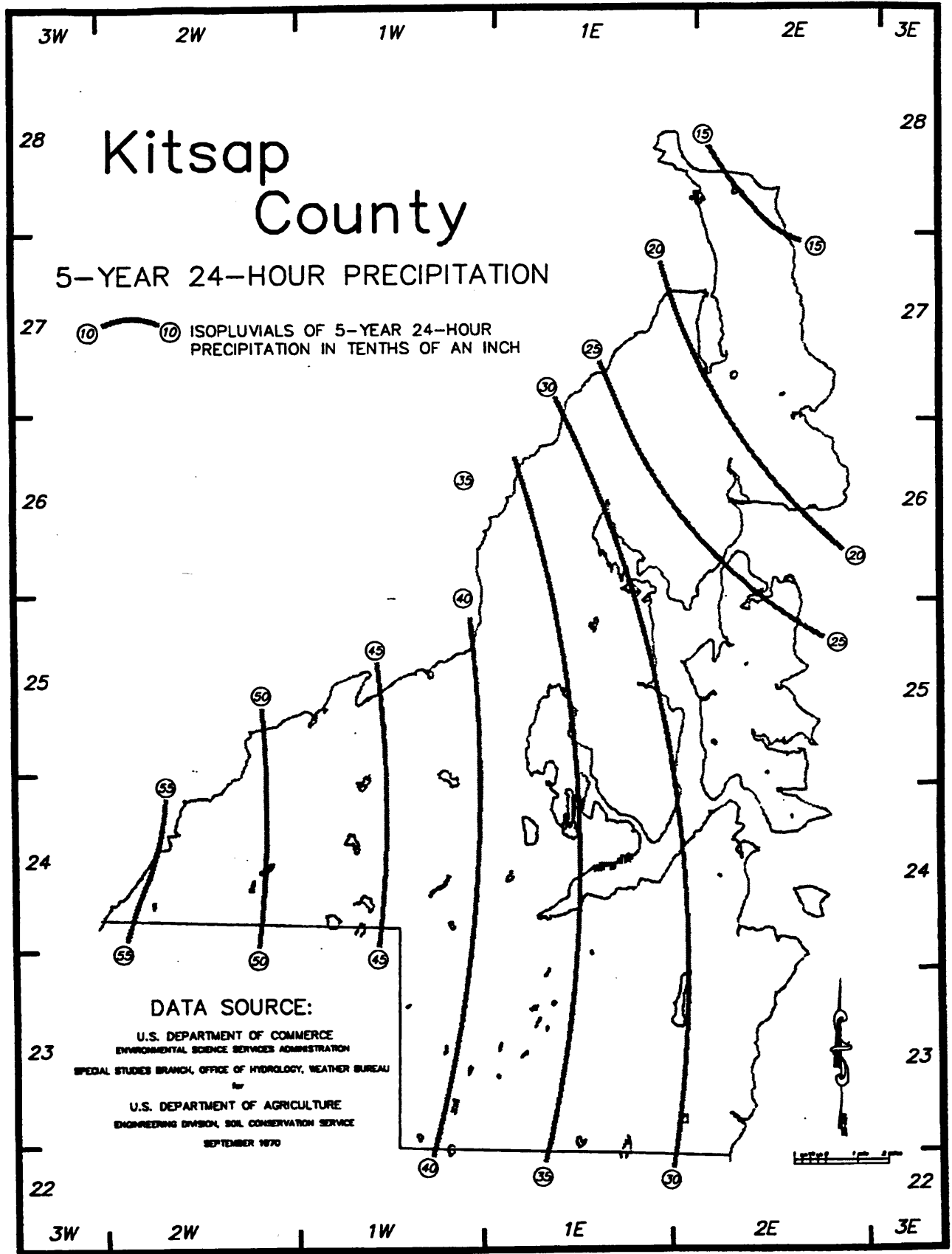


FIGURE 5-3 ISOPLUVIAL MAP - 10 YEAR

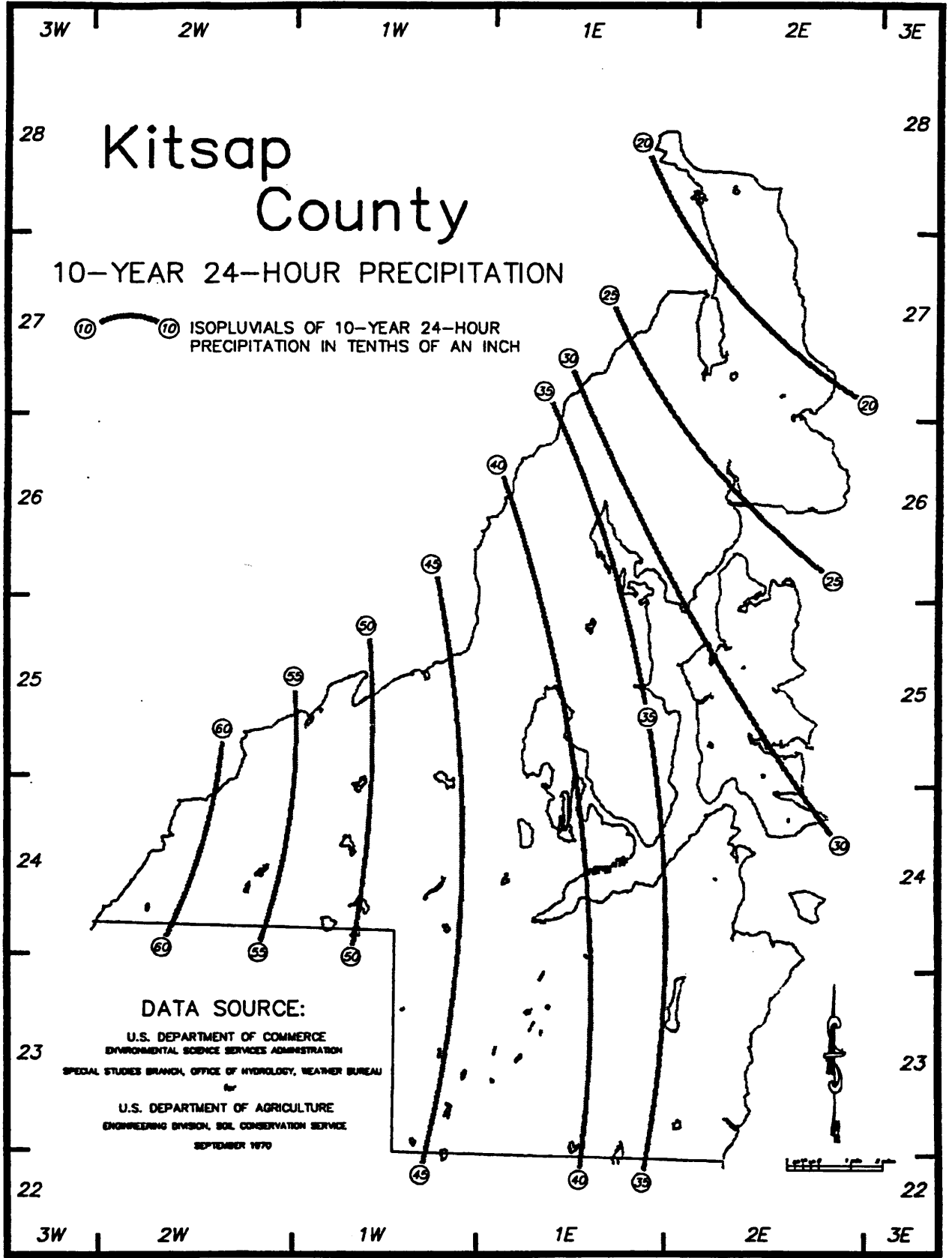


Figure 5-4 ISOPLUVIAL MAP - 25 YEAR

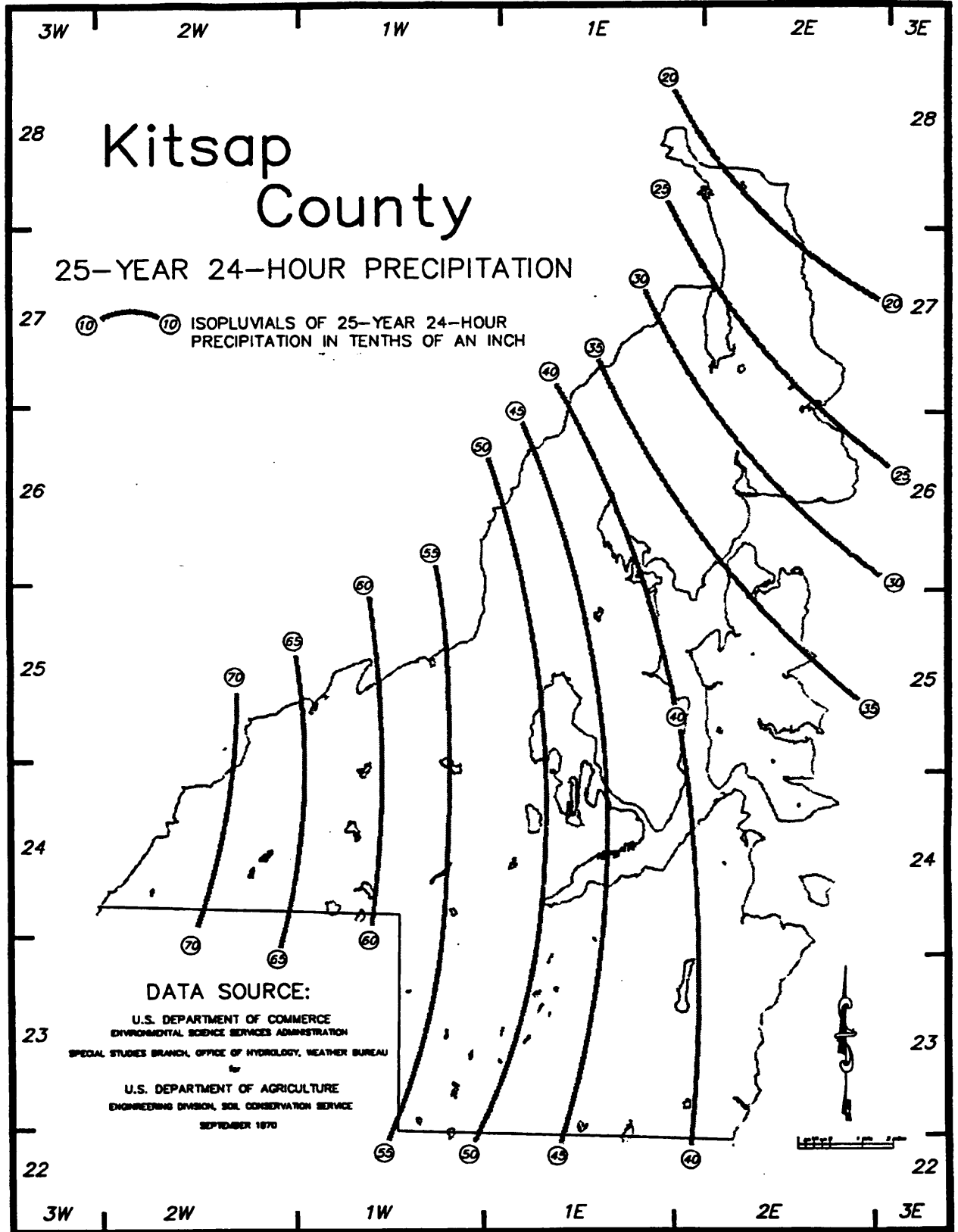


Figure 5-5 ISOPLUVIAL MAP - 50 YEAR

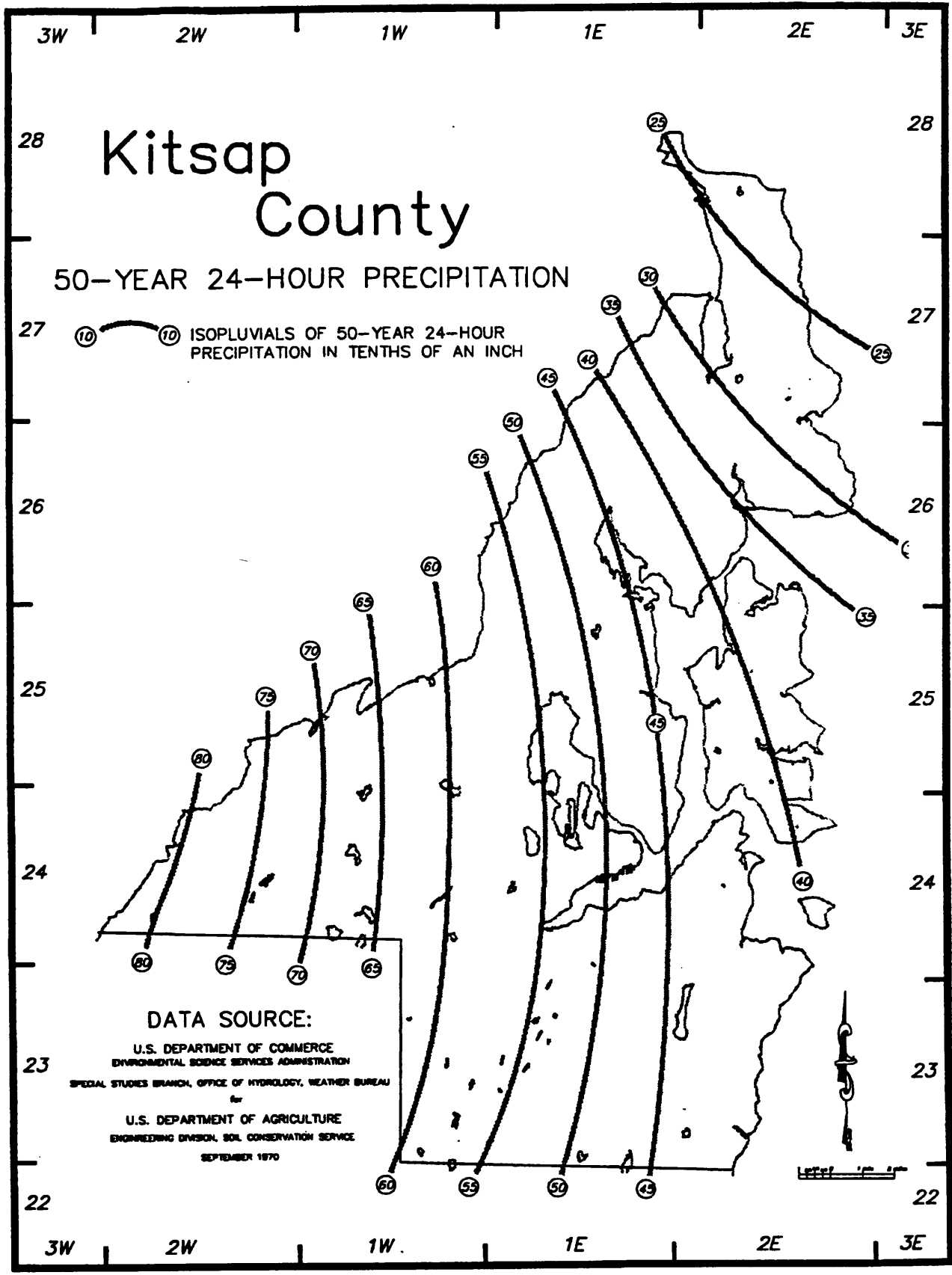




Figure 5-6 ISOPLUVIAL MAP - 100 YEAR

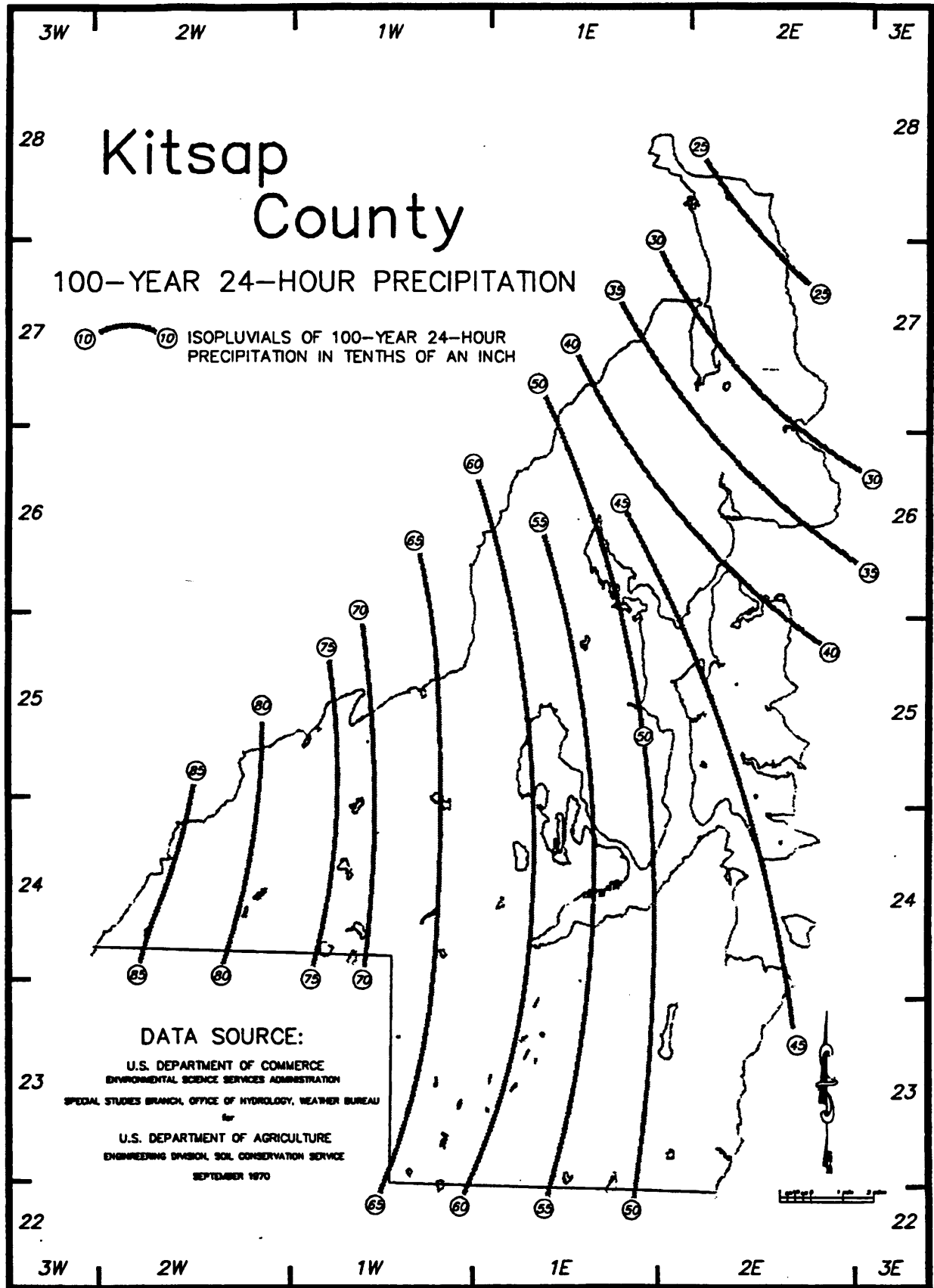
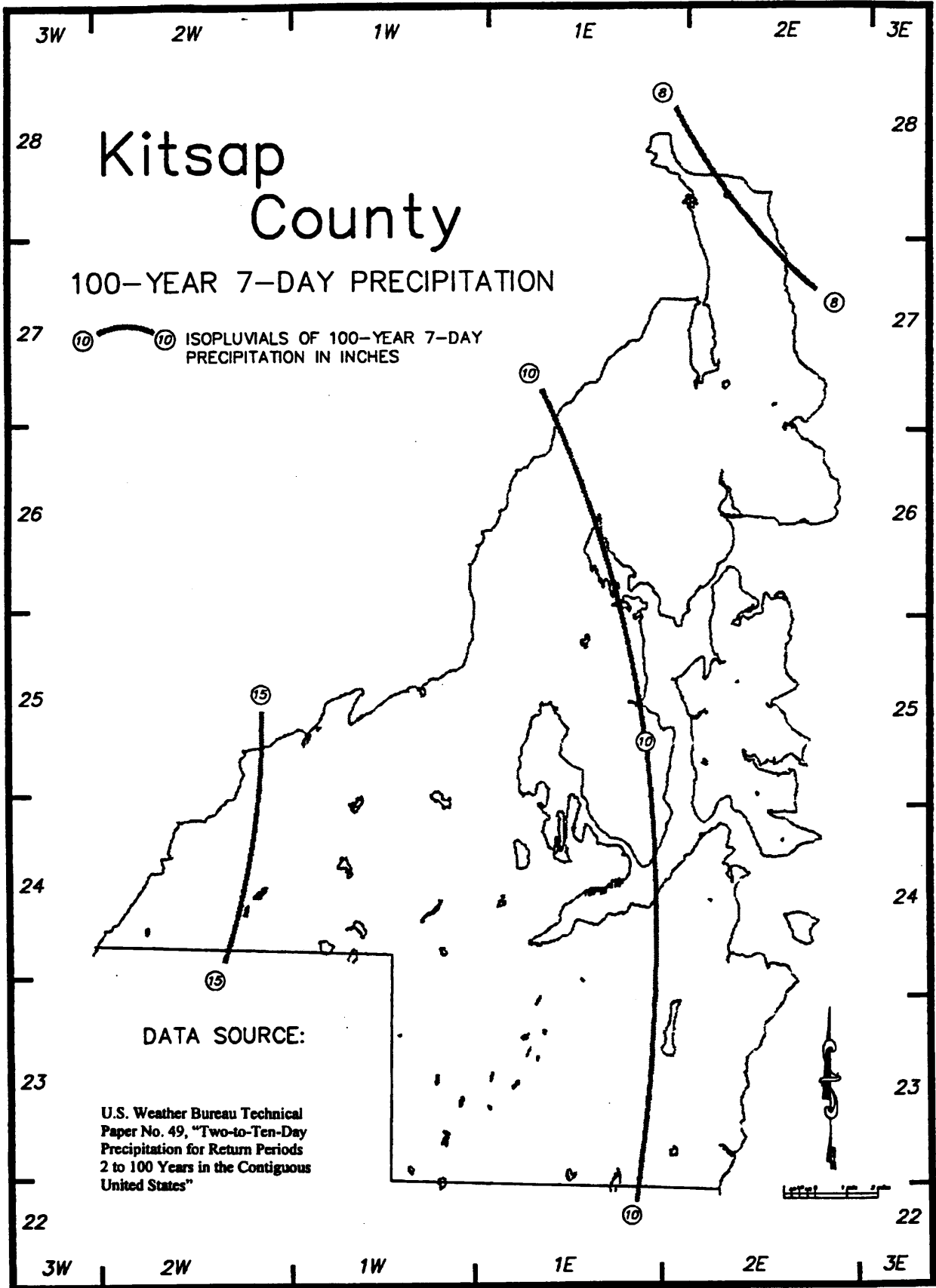


Figure 5-7 ISOPLUVIAL MAP - 100 YEAR, 7 DAY



## CURVE NUMBERS

SCS has post-development "curve number" (CN) values based on soil type and land use. These curve numbers have been assigned to one of four hydrologic soil groups according to their runoff characteristics. Table 5-1 identifies the hydrologic soil groups for the most common soils in Kitsap County. This list is derived from the soils listed in the SCS Soil Survey for Kitsap County together with the comprehensive hydrologic soil group listing found in the SCS TR-55 literature.

The curve numbers included in the D.O.E. Technical Manual have been modified by SCS to more accurately reflect conditions common to the Puget Sound area. Generally, the curve numbers appearing in the D.O.E. Technical Manual tend to be higher than those found in the SCS TR-55 literature. Kitsap County requires that these modified curve numbers, as listed in Table 5-2, be used in any hydrological analysis. More conservative curve number values are acceptable.

For storm durations other than 24 hours, an adjustment must be made to the CN values given in Table 5-2. Based on information obtained from SCS, the following equation shall be used for adjusting these CN's for the 7-day design storm:

$$CN_{7\text{-day}} = 0.1549 CN + 0.8451 ((CN^{2.365}/631.8) + 15)$$

Note that some commercially available software performs this adjustment automatically.

Individual curve numbers for a basin must be merged into a "composite" curve number for use as input in either the SCS method or the SBUH method. The SBUH method further requires that a separate composite curve number be computed for the pervious portion and the impervious portion of the site.

To compute composite curve numbers, the following steps should be followed:

1. Break a basin down into areas of differing ground cover or land use.
2. Break down each of these areas based on the homogeneous characteristics on an area (soil groups, pervious versus impervious, etc.).
3. Determine the land area, in acres, for each of these sub-areas and note the curve number for that sub-area.
4. Compute the total acreage and the composite pervious curve number. The composite curve number should be derived by taking the area times the curve number of each of the pervious sub-areas and then dividing this sum by the total area:

$$\text{Composite CN} = \frac{(CN \times A)_1 + (CN \times A)_2 + \dots + (CN \times A)_N}{A_{\text{total}}}$$

Table 5-1 HYDROLOGIC SOIL GROUP OF THE SOILS OF KITSAP COUNTY\*

SOIL GROUP	HYDROLOGIC GROUP	SOIL GROUP	HYDROLOGIC GROUP
Alderwood	C	Mukilteo	C/D
Beaches	Variable	Neilton	A
Belfast	B	Norma	C/D
Bellingham	C/D	Pits	Variable
Cathcart	B	Poulsbo	C
Dystric Xerorthents	Variable	Ragnar	B
Grove	A	Schneider	B
Harstine	C	Semiahmoo	C/D
Indianola	A	Shalcar	C/D
Kapowsin	D	Shelton	C
Kilchis	C	Sinclair	C
Kitsap	C	Tacoma	D
McKenna	C/D	Urban	Variable

#### HYDROLOGIC SOIL GROUP CLASSIFICATIONS

A. (Low Runoff Potential). Soils having high infiltration rate, even when thoroughly wetted, and consisting chiefly of deep, well-to-excessively drained sands or gravels. These soils have high rate of water transmission.

B. (Moderately low runoff potential). Soils having moderate infiltration rates when thoroughly wetted, and consisting chiefly of moderately fine to moderately coarse textures. These soils have a moderate rate of water transmission.

C. (Moderately high runoff potential) Soils having slow infiltration rates when thoroughly wetted, and consisting chiefly of soils with a layer that impedes downward movement of water, or soils with moderately fine to fine textures. These soils have a low rate of water transmission.

D. (High runoff potential). Soils having very slow infiltration rates when thoroughly wetted and consisting chiefly of clay soils with a high swelling potential, soils with a permanent high water table, soils with a hardpan or clay layer at or near the surface, and shallow soils over nearly impervious material. These soils have very slow rate of water transmission.

Note: Two Hydrologic soils groups such as C/D indicates the Drained/Undrained situation

\*From SCS, TR-55, Second Edition, June 1986, Exhibit A-1.  
SDS Soil Survey of Kitsap County Area Table 16

Table 5-2 MODIFIED CURVE NUMBERS

LAND USE DESCRIPTION		Curve Numbers by Soil Group				
		A	B	C	D	
Cultivated land <sup>1</sup> :	Winter condition	86	91	94	95	
Mountain Open Areas:	Low growing brush and grassland	74	82	89	92	
Meadow or pasture:		65	78	85	89	
Wood or forest:	Undisturbed	42	64	76	81	
	Established second growth <sup>4</sup>	48	68	78	83	
	Young second growth or brush	55	72	81	86	
Orchard:	With cover crop	81	88	92	94	
Open Spaces:	Good condition <sup>6</sup> :	Grass cover on >= 75% of area	68	80	86	90
	Fair condition					
Gravel roads and parking lots		76	85	89	91	
Dirt roads and parking lots <sup>5</sup> :		72	82	87	89	
Impervious surfaces		98	98	98	98	
Open water bodies	Wetlands, lakes, ponds, etc	100	100	100	100	
Single Family Residential <sup>2</sup> :		Separate curve numbers shall be selected for pervious and impervious portions of the site or basin				
Dwelling Units/Gross Acre	% Impervious <sup>3</sup>					
1.0 DU/GA	15					
1.5 DU/GA	20					
2.0 DU/GA	25					
2.5 DU/GA	30					
3.0 DU/GA	34					
3.5 DU/GA	38					
4.0 DU/GA	42					
4.5 DU/GA	46					
5.0 DU/GA	48					
5.5 DU/GA	50					
6.0 DU/GA	52					
6.5 DU/GA	54					
7.0 DU/GA	56					
All other uses must compute % impervious based on actual ground cover						

**Foot notes:**

- 1: For a more detailed description of agricultural land use curve numbers, refer to National Engineering Handbook, Sec 4, Hydrology, Chapter 9, August 1972.
- 2: Assumes roof and driveway runoff is directed into street/storm system
- 3: The remaining pervious areas (lawn) are considered to be in good condition for these curve numbers
- 4: Modified by KCPW, 1995.
- 5: Pervious pavers and pervious pavement used for single family residences or other similar very low traffic situations may be modeled as dirt road/parking.
- 6: Lawn and landscaped areas that contain composted amendments per table 5-6 may be modeled as pasture.

## TIME OF CONCENTRATION

The time of concentration ( $T_c$ ) is the length of time for runoff to travel from the hydraulically most distant point of a watershed to the point of discharge from the watershed. For computation purposes, it is assumed that water moves through the watershed as sheetflow (having a maximum depth of 0.1-foot), as shallow concentrated flow (having a maximum depth exceeding 0.1-foot), and as open channel flow.

It is assumed that runoff in a watershed begins as sheetflow. It is also assumed that regardless of site conditions, the maximum distance that runoff will travel in the form of sheetflow will not exceed 300-feet. Where there are no topographic features suggesting channel flow within the first 300-feet of flow, it may be assumed that the first 300-feet of flow is sheetflow and the remaining flow distance until water reaches a channel is shallow concentrated flow.

For further discussion of methods of computing time of concentration, the designer is referred to the Washington State Department of Ecology "Stormwater Manual".

For computing the travel time of sheetflow, the following formula should be used:

$$T = \frac{0.42 (n_s L)^{0.8}}{(P_2)^{0.5} (s_o)^{0.4}}$$

where	T	=	travel time, in minutes
	$n_s$	=	Manning's roughness coeff.-sheetflow (Table 5-3)
	L	=	flow length, in feet
	$P_2$	=	2-year, 24-hour rainfall, in inches (Figure 5-1)
	$s_o$	=	slope of land, in feet per foot

Note that when the SCS TR-55 Hydrograph Method is used, the travel time, "T", must be converted from minutes to hours.

Travel time for shallow concentrated flow and open channel flow is computed using the following formula:

$$T = \frac{L}{V \times 60}$$

where	T	=	travel time, in minutes
	L	=	flow length, in feet
	V	=	average velocity, in feet per second
	60	=	conversion factor from seconds to minutes

Table 5-3 MANNING'S COEFFICIENTS/"K" FACTORS

"n" AND "k" Values Used in Time Calculations for Hydrographs

"n <sub>s</sub> " Sheet Flow Equation Manning's Values (for the initial 300 ft. of travel)	n <sub>s</sub>
Smooth surfaces (concrete, asphalt, gravel, or bare hand packed soil)	0.011
Fallow fields or loose soil surface (no residue)	0.05
Cultivated soil with residue cover (s ≤ 0.20 ft/ft)	0.06
Cultivated soil with residue cover (s > 0.20 ft/ft)	0.17
Short prairie grass and lawns	0.15
Dense grasses	0.24
Bermuda grass	0.41
Range (natural)	0.13
Woods or forest with light underbrush	0.40
Woods or forest with dense underbrush	0.80

\*Manning values for sheet flow only, from Overton and Meadows 1976 (See TR-55, 1986)

"k" Values Used in Travel Time/Time of Concentration Calculations

Shallow Concentrated Flow (After the initial 300 ft. of sheet flow, R = 0.1)	k <sub>s</sub>
1. Forest with heavy ground litter and meadows (n = 0.10)	3
2. Brushy ground with some trees (n = 0.060)	5
3. Fallow or minimum tillage cultivation (n = 0.040)	8
4. High grass (n = 0.035)	9
5. Short grass, pasture, and lawns (n = 0.030)	11
6. Nearly bare ground (n = 0.025)	13
7. Paved and gravel areas (n = 0.012)	27

**Channel flow (intermittent) (At beginning of visible channels R = 0.2)	k <sub>c</sub>
1. Forested swale with heavy ground litter (n = 0.10)	5
2. Forested drainage course/ravine with defined channel bed (n = 0.050)	10
3. Rock-lined waterway (n = 0.035)	15
4. Grassed waterway (n = 0.030)	17
5. Earth-lined waterway (n = 0.025)	20
6. CMP pipe (n = 0.024)	21
7. Concrete pipe (0.012)	42
8. Other waterways and pipe 0.508/n	

Channel Flow (Continuous stream, R = 0.4)	k <sub>c</sub>
9. Meandering stream with some pools (n = 0.040)	20
10. Rock-lined stream (n = 0.035)	23
11. Grass-lined stream (n = 0.030)	27
12. Other streams, man-made channels and pipe 0.807/n**	

\*\*See Table 7-3 for additional Mannings "n" values for open channels.

Average velocity is computed using the following formula:

$$V = k\sqrt{s_o}$$

where: V = velocity, in feet per second  
k = velocity factor, in feet per second (Table 5-3)  
s<sub>o</sub> = slope of flow path, in feet per foot

Table 5-3 lists Manning's roughness coefficient, "n<sub>s</sub>", for sheetflow and also velocity factor "k" for shallow concentrated flow and open channel flow. The factors in Table 5-3 should be used for both the SCS or SBUH methods. Note that the "n<sub>s</sub>" values given in Table 5-3 are only appropriate for sheetflow conditions.

Time of concentration, for input in either the SCS method or the SBUH method, is the sum of the travel times for sheetflow, shallow concentrated flow and channel (intermittent) flow.

In computing the time of concentration, it is important to note that, except for very large basins, the largest and most significant component in the total time of concentration is that portion of the time devoted to sheetflow. For this reason, extreme care should be given to realistically determining the true travel time for the sheetflow component of the time of concentration. In reviewing the hydrological analysis, county staff will pay close attention to this factor.

In calculating total time of concentration, the following limitations will apply:

1. The flow segment used for the sheetflow component of the total time of concentration should not extend for more than 300'.
2. For segments of the Tc route flowing through closed conveyance facilities, such as pipes and culverts, standard hydraulics formulas should be used for establishing velocity and travel time.
3. For segments of the Tc route flowing through lakes or submerged wetlands, travel time is normally very short. The travel time can be determined using an appropriate storage routing technique, or it can be assumed to be "zero".

### **5.2.3 DESIGN STRATEGIES**

In order to aid the engineer in designing a runoff quantity control facility, the following comments are offered. Kitsap County encourages innovative design to stormwater management; therefore, consideration will be given to other reasonable design strategies.



## DRAINAGE BASIN DELINEATION

Within an overall drainage basin which is contributing stormwater to a runoff control facility, it may be necessary to delineate separate sub-basins and to then generate separate hydrographs for each sub-basin. Sub-basins must be delineated when there are areas within a larger basin that are hydraulically self-contained, or that have similar land use and/or runoff characteristics. When several sub-basins are contributing runoff to a single runoff control facility, the individual hydrographs from each sub-basin should be added together to produce a single hydrograph representing runoff flows to the facility. When adding hydrographs, it is important that the travel time be taken into consideration, from the discharge point of a given sub-basin to the runoff control facility.

## OFF-SITE CONTRIBUTING RUNOFF

In general, off-site contributing runoff may only be routed through the runoff control facility if the pre-development peak 2-year and 100-year flow rates from the off-site contributing area do not exceed the pre-development on-site peak flow rates for the same storm events. Otherwise, off-site flows should be routed through the project site separate from the on-site flows.

If off-site flows are to be routed through the runoff control facility, orifice sizes should generally not be increased to accommodate off-site flows. Instead, additional freeboard should be provided so that offsite flows can be discharged through the control structure without overtopping the emergency overflow spillway .

## BYPASS AREAS

Runoff from small portions of a development site may be permitted to be released at post-development rates (uncontrolled) provided that: (1) the "bypass" area rejoins the pre-development downstream drainage course within a relatively short distance downstream of the runoff control facility; (2) the design engineer has demonstrated in the downstream analysis and in capacity calculations that the downstream drainage course conveying the uncontrolled flows from the "bypass" area will not be adversely impacted by the increased runoff rate; (3) easements are obtained from all downstream property owners through whose property the undetained runoff flows prior to rejoining the detained runoff from the site; and (4) the total release rate from the project site, including the "bypass" area, shall not exceed the total allowable release rates from the project site. In the event that the downstream drainage course will be adversely impacted by increased runoff from the "bypass" area, downstream improvements will be required, along with an easement from the affected downstream property owner(s).

## CORRECTION FACTORS

When designing streambank erosion control BMPs by the SBUH Method, it will be necessary to increase the facility size by applying a correction factor to the calculated storage volume. The correction factor shall be applied to the volume without changing the depth or the design of the outlet structure. The required correction factor, which is based on the site impervious cover, is shown on Figure 5-8. Note that the factor does not apply to infiltration facilities or those designed by a continuous simulation model such as HSPF.

### **5.3 FACILITY DESIGN REQUIREMENTS**

The term "detention facility" commonly refers to the temporary storage of water for eventual gradual release to a downstream surface drainage course. "Retention", on the other hand, commonly refers to the permanent storage of stormwater. Actually, a retention facility also temporarily stores water for eventual gradual release through evaporation as well as infiltration to the groundwater system.

Detention facilities usually take the form of open ponds, underground tanks, and vaults. Retention facilities are most often open ponds or other open depressions, or they are underground infiltration systems. The Director may allow a retention system to be designed with some controlled release where it has been demonstrated that downstream conditions will not be adversely impacted by such a controlled release of stormwater.

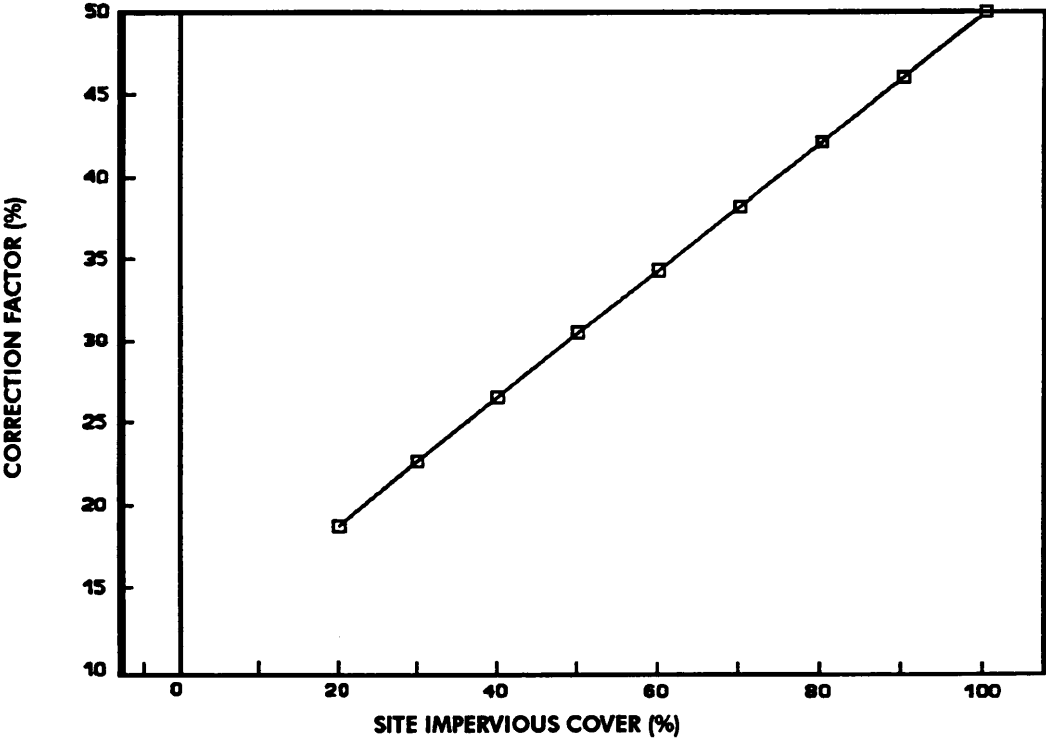
All runoff quantity control facility designs must address overflow caused both as a result of plugging of the normal outlet and also as a result of stormwater conditions that exceed the design capacity of the facility. The engineering design of all runoff quantity control facilities must identify the route of overflow from a storage facility, following the corridor of least resistance, to the point where this overflow enters the existing downstream drainage system.

#### **5.3.1 PONDS**

Open ponds for runoff quantity control are encouraged by Kitsap County when site constraints allow.

Also, Kitsap County encourages the design of runoff quantity control ponds to function as multi-purpose facilities (such as parks, recreation or sports facilities, or parking lots), provided that any alternative uses are compatible with their primary stormwater functions and with maintenance standards. Every effort will be made by Department of Public Works staff to cooperate in the development of such a facility.

Figure 5-8 VOLUME CORRECTION FACTOR



Finally, Kitsap County encourages the use of regional ponds serving more than one development. Regional facilities can be more effective in improving water quality, can be more cost effective not only to construct but also to maintain, and can be more easily designed to serve as a multi-purpose facility.

The following design criteria apply to open ponds:

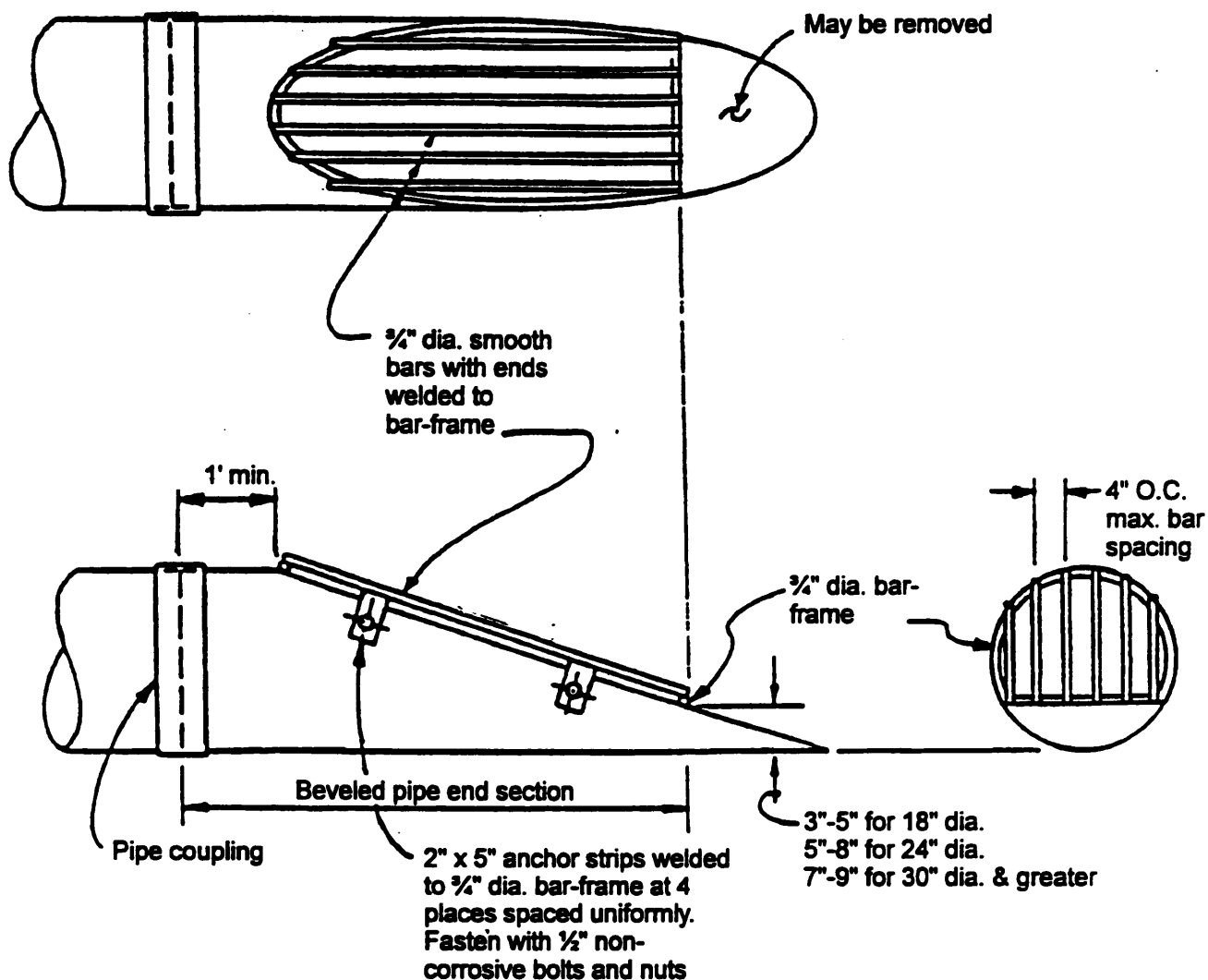
### SITE CONSTRAINTS

1. All open ponds to be maintained by Kitsap County shall be located in a separate tract dedicated to Kitsap County. Open ponds shall not be located in dedicated public road right-of-way areas.
2. Open ponds that are designed to function as multi-use recreational facilities shall be located in a separate tract or in designated open space and shall be privately maintained.

### POND GEOMETRICS

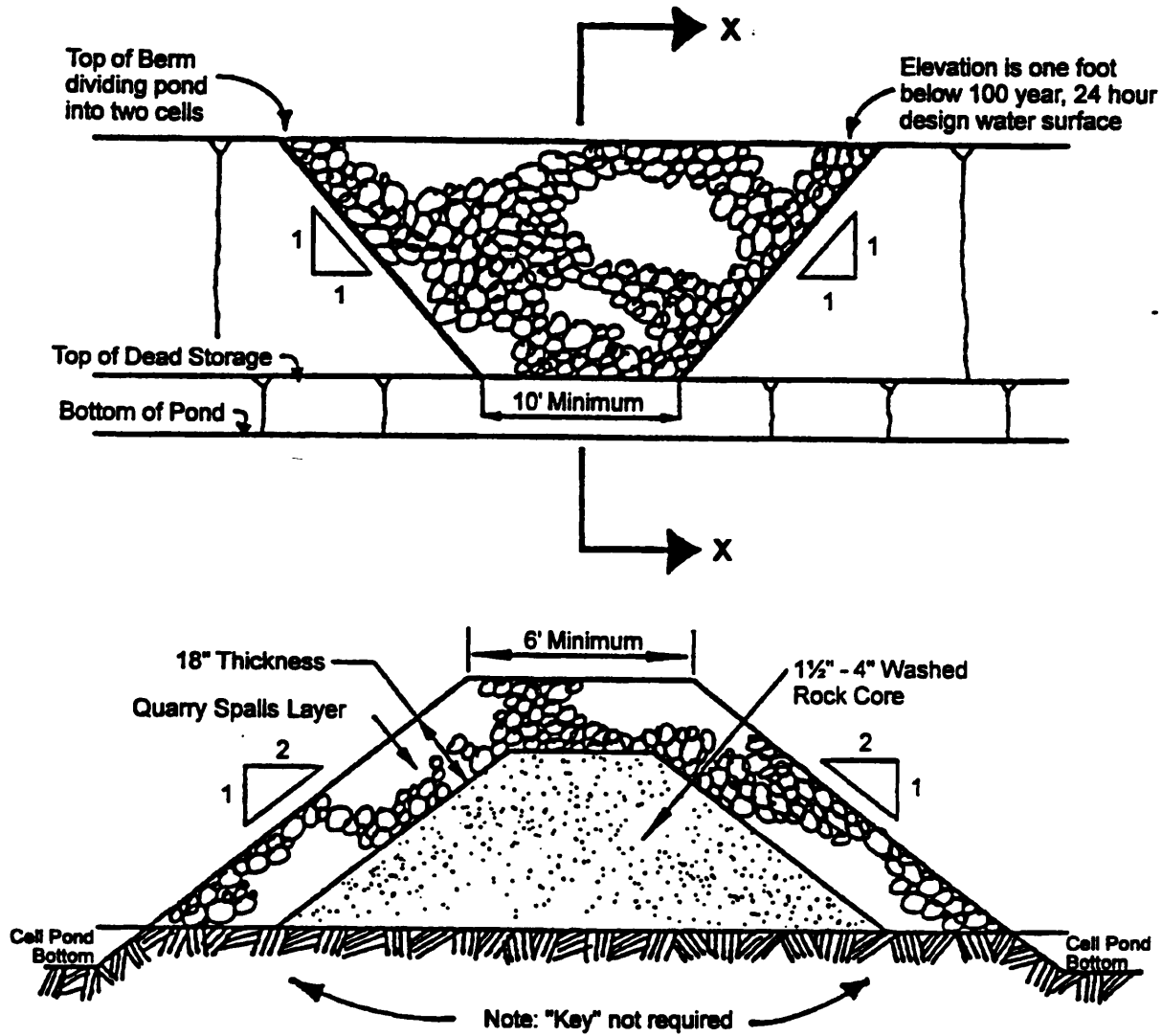
1. Open ponds shall be designed to have a minimum of 1-foot of freeboard above the maximum design water surface elevation.
2. Ponds shall have a minimum length to width ratio, at the maximum water surface, of 2:1 in order to enhance water quality benefits. Higher length to width ratios may be required (for example, see Chapter 6, Stormwater Quality Control Facilities, for wetpond design criteria).
3. All pond outlet pipes shall be provided with a Debris Barrier (see Figure 5-9).
4. Ponds shall be designed as "flow-through" facilities with two or more sequential "cells" divided by a gravel filter window (see Figure 5-10). The top of the gravel filter window should be set 1-foot below the maximum design water surface elevation.
5. For multi-cell detention ponds, the upstream cell ("forebay") shall be designed for the entrapment and containment of sediment. The bottom of this "forebay" shall be flat and designed to provide a minimum of 0.5-feet of dead storage for sediment. This dead storage may not be included in the calculation of total available detention storage for the pond. The 0.5 feet of available sediment storage assumes that both cells of the pond are approximately equal in size. In the event that the "forebay" is less than one half of the total pond volume, the depth of available sediment storage shall be proportionately increased to provide the equivalent volume of sediment storage. See Chapter 6, Stormwater Quality Control Facilities, for additional forebay sizing criteria that may be required on some ponds for water quality purposes.

Figure 5-9 DEBRIS BARRIER DETAIL



**Note:**  
1. CMP end-section shown.

Figure 5-10 GRAVEL FILTER WINDOW



6. All ponds with a permanent pool depth exceeding 18-inches, or side slopes steeper than 4H:1V, shall be fenced. Interior side slopes above the freeboard elevation of unfenced ponds may be as steep as 2H:1V provided that a 10' wide safety bench is provided at the point of slope transition. For safety reasons, all ponds with a permanent pool depth exceeding 18-inches shall have maximum side slopes of 3H:1V in addition to perimeter fencing. Exterior pond side slopes shall be no steeper than 2H:1V.
7. Pond walls may be designed as retaining walls, provided that: (1) the design is prepared and stamped by a qualified engineer registered in the State of Washington, (2) at least 25% of the pond perimeter will be a vegetated soil slope of not greater than 3H:1V, (3) maintenance access is provided to the bottom of the pond, and (4) a fence is provided around the entire perimeter of the pond.

### SETBACKS

1. Ponds shall maintain minimum setback distances as follows:
  - 10 feet - maximum water surface to property lines and structures
  - ½ berm height, 5 feet minimum, 20 feet maximum - from toe of pond berm embankment to nearest tract property boundary lines
  - 10 feet - maximum water surface to septic tank or distribution box\*
  - 30 feet - maximum water surface to septic drainfields\*
  - 200 feet - maximum water surface to top of slopes steeper than 30%\*\*
  - 100 feet - wells

\*The Bremerton Kitsap County Health District (BKCHD) may require greater setbacks

\*\*A deviation from these setbacks may be granted by the Director with recommendations from a qualified geotechnical engineer.

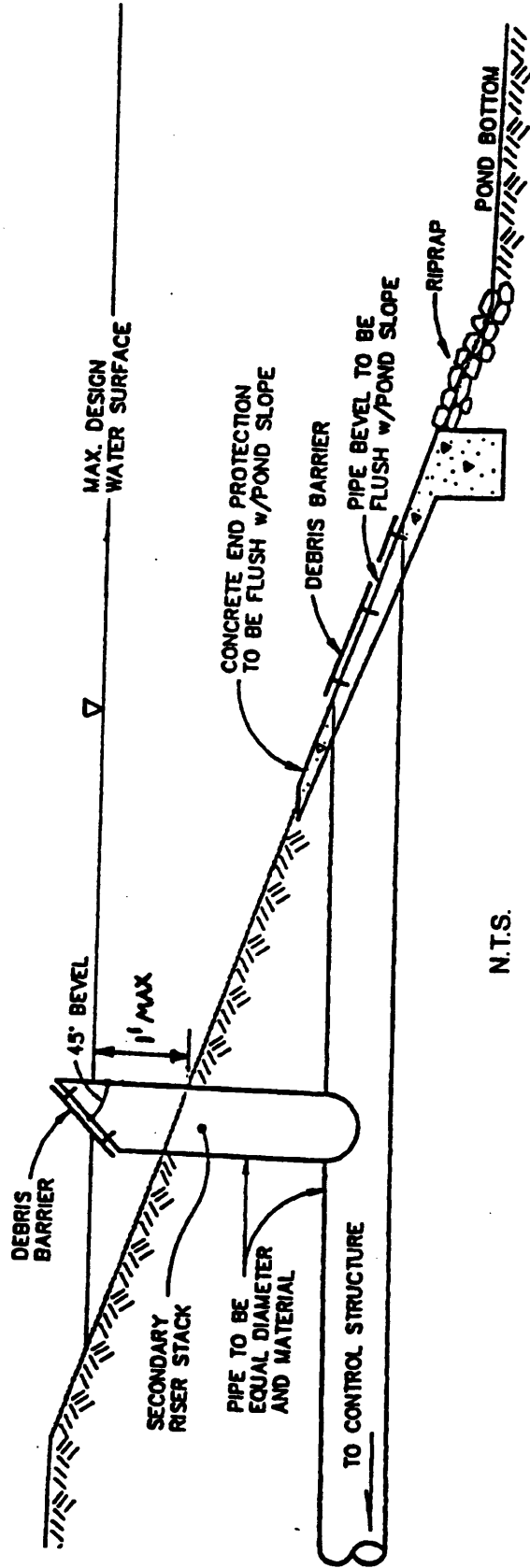
Where pond setbacks cross property lines, siting of such facilities will not be allowed without written authorization from the affected property owner.

2. Manholes and catch basins shall maintain a minimum separation of 5 feet from the face of the structure to any adjacent tract or property boundary.

### OVERFLOW

1. The detention pond outlet pipe shall be fitted with a secondary riser stack to convey runoff to the control structure in the event that the entrance to the outlet pipe becomes plugged. Figure 5-11 is a standard detail for the secondary riser stack.

Figure 5-11 SECONDARY RISER STACK





2. All ponds shall be provided with an emergency overflow spillway designed to safely pass the 100-year, 24 hour design storm event for post-development site conditions assuming the pond is full to the crest of the spillway. The emergency overflow spillway is intended to provide safe overflow over the pond embankment in the event of control structure failure or for storm/runoff events exceeding design. The subgrade of the spillway should be set at or above the 100-year, 24-hour overflow elevation of the control structure. The spillway shall be located to direct overflows safely towards the downstream conveyance system and shall be located in existing soil wherever feasible. The emergency overflow spillway shall be armored with 6" median diameter rip rap in conformance with Section 9-13 of the WSDOT/APWA Standard Specifications and shall extend to the toe of each face of the berm embankment.

The emergency overflow spillway weir section (see Figure 5-12) shall be designed for the maximum design storm event for post-development conditions, using the following formula:

$$L = \frac{Q_{100}}{3.21 H^{\frac{3}{2}}} - 2.4 H^2$$

where

L	=	Length of bottom of weir, in feet (6-foot min.)
Q <sub>100</sub>	=	100-year, 24-hour post-development flow rate, in cfs
H	=	Height of emergency overflow water surface, in feet (0.2-foot minimum)

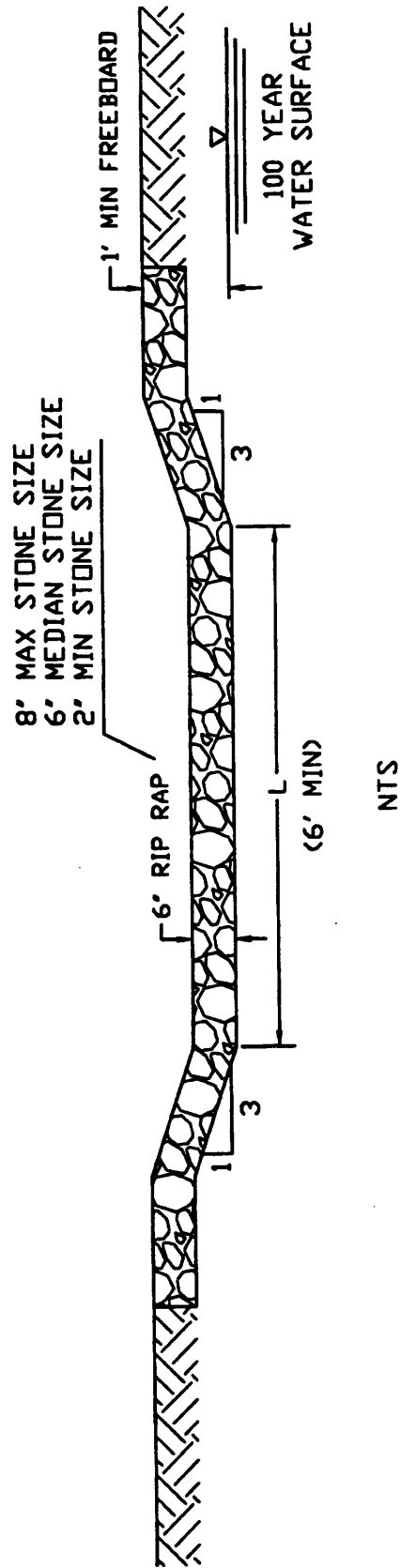
### FENCING

- o Fencing, where required around a pond, shall consist of a minimum 6' high chain link fence. A minimum of one locking access road gate shall be provided that is 16' wide consisting of two swinging sections 8' in width. Any proposed pedestrian-only access gates shall be a minimum of 4' in width. Fence material shall be No. 11 gauge galvanized steel fabric with bonded vinyl coating. Vinyl coating shall be green in open areas and black in wooded areas. Fence posts shall be galvanized steel, with top caps, and set a minimum of 3-feet deep in concrete. Cross bars shall connect adjacent fence posts, with diagonal braces at corners and ends. All posts, cross bars and gates shall be painted or coated the same color as the vinyl clad fence.

### SIGNING

- o All ponds shall have signs placed so that at least one is clearly visible and legible from all adjacent streets, sidewalks or paths. Signs shall meet the design and installation requirements illustrated in Figure 5- 13.

Figure 5-12 EMERGENCY OVERFLOW SPILLWAY WEIR SECTION





**Kitsap County  
Storm Water  
Management Facility**



**DO NOT  
ENTER**



**For more information call 876-7121**

**Specifications**

- |                      |   |
|----------------------|---|
| <b>Size:</b>         | 30" x 24"   |
| <b>Material:</b>     | Aluminum with white reflective sheeting<br>Silk screen lettering  |
| <b>Installation:</b> | Secured to chain link fence if available,<br>otherwise installed on 8' x 4" x 4" post<br>buried 30" into the ground |

## BERM EMBANKMENT/SLOPE STABILIZATION

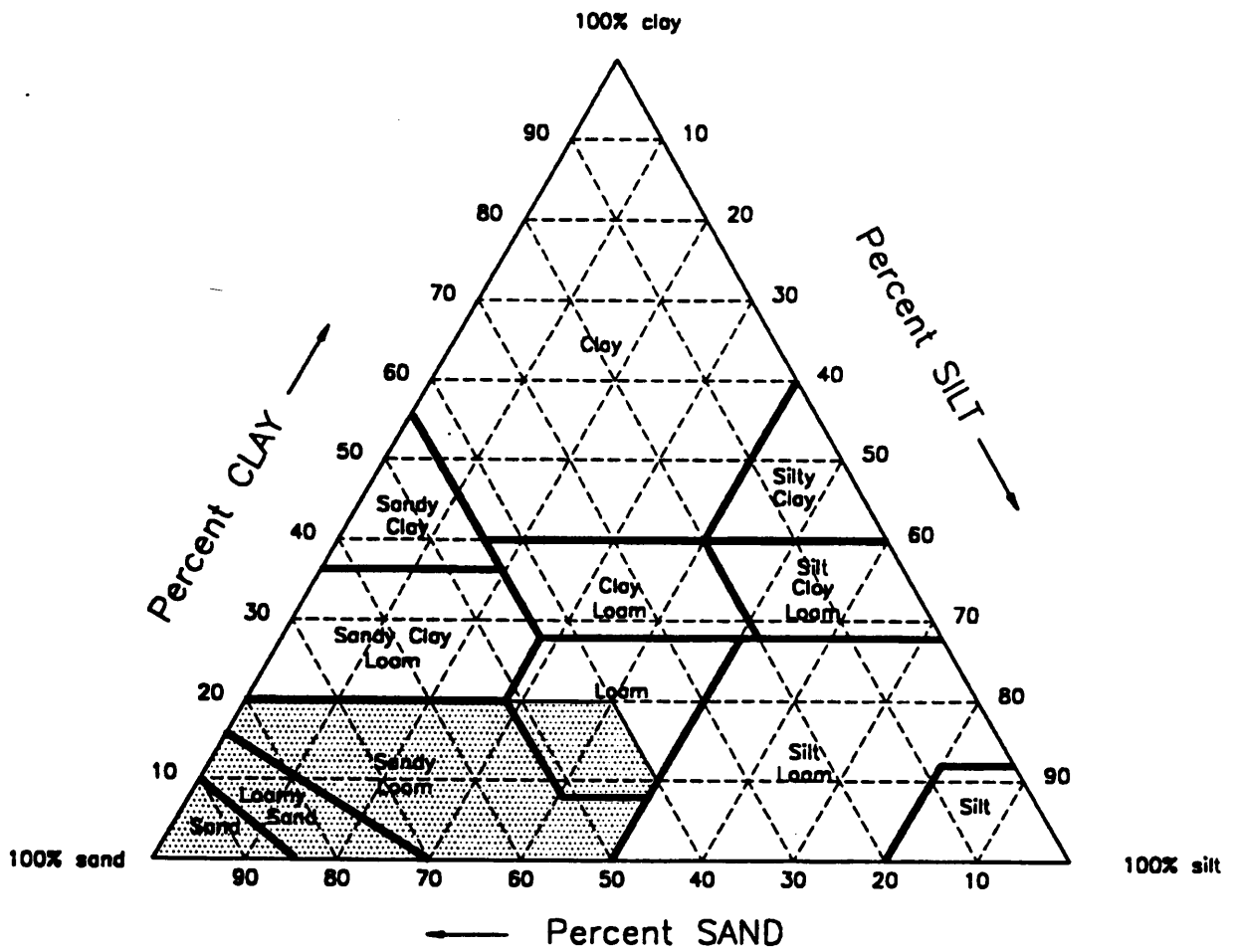
1. Pond berm embankments shall be constructed on native consolidated soil (or adequately compacted and stable fill soils), which is free of loose surface soil materials, roots and other organic debris.
2. Pond berm embankments shall be constructed by excavating a "key" equal to 50% of the berm embankment cross-sectional height and width measured through the center of the berm (except on till soils where the "key" minimum depth can be reduced to 1-foot of excavation into the till).
3. The berm embankment shall be constructed of compacted soil (95% maximum dry density, Modified Proctor method per ASTM D1557) placed in 6 to 8 inch lifts with hand held equipment and 10 to 12 inch lifts with heavy equipment, with the following soil characteristics per the United States Department of Agriculture's Textural Triangle: a minimum of 30% clay, a maximum of 60% sand, a maximum of 60% silt, with nominal gravel and cobble content (Note: in general, excavated glacial till will be well-suited for berm embankment material). See Figure 5-14 for USDA's Textural Triangle.
4. Anti-seepage collars shall be placed on outflow pipes in berm embankments impounding water greater than 8-feet in depth.
5. Exposed earth on the pond side slopes shall be sodded or seeded with appropriate seed mixture (see Chapter 3, Erosion and Sedimentation Control). Establishment of protective vegetative cover shall be ensured with appropriate surface protection BMPs and reseeded as necessary.
6. Pond berm embankments 6-feet or less in height including freeboard, measured through the center of the berm, shall have a minimum top width of 6-feet, unless otherwise recommended by a qualified engineer.
7. Where maintenance access is provided along the top of berm, the minimum width of the top of berm shall be 15-feet.
8. Pond berm embankments greater than 6-feet in height, as measured through the center of the berm, shall require design by a qualified geotechnical engineer licensed in the State of Washington. Berm embankment width shall otherwise vary as recommended by the engineer.

## ACCESS

1. Pond access roads shall provide access to the control structure(s) and alongside the pond as necessary for vehicular maintenance access to the pond forebay. For ponds with forebay bottoms which cannot be accessed from the top edge of the forebay by a backhoe with a maximum reach of 20 feet, an access road shall be constructed extending to the bottom of the first cell, having a minimum width of 15-feet and a maximum steepness of 20%.

Figure 5-14 TEXTURAL TRIANGLE U.S.D.A.

# Textural Triangle U.S.D.A.



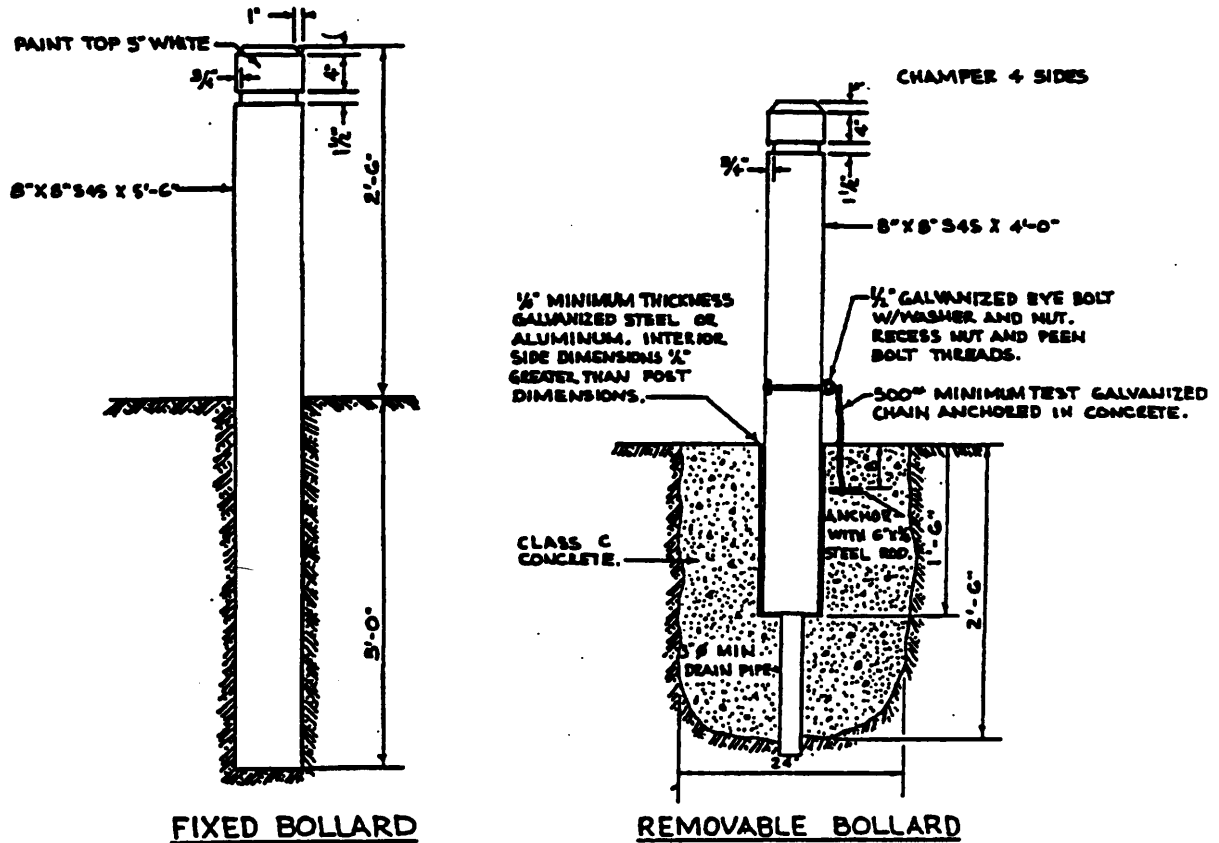
2. Access roads to control structures shall have a maximum slope of 12%. A means shall be provided for vehicle turn around, allowing for a 40-foot minimum outside turning radius. Access roads to the pond bottom shall allow for a vehicle to approach the pond, turn and back down the access ramp into the pond.
3. Vehicle access shall be limited by bollards if the pond is not fenced. Bollards (see Figure 5-15) shall consist of two fixed bollards on each side of the access road and two removable bollards equally located between the fixed bollards.
4. Pond access roads shall be constructed by utilizing one of the following techniques:
  - a. Construct an asphalt surface meeting Kitsap County Standards; OR
  - b. Construct a gravel surface road by removing all unsuitable material, providing a minimum 6" of suitable subgrade material compacted to 95%, and providing a minimum 2" thick crushed rock surface; OR
  - c. Construct a landscape block surface by removing all unsuitable material, laying a geotextile fabric over the native soil, placing landscape blocks, filling the honeycombs with soil particles, and planting grass.
5. When the length of a pond access road exceeds 40-feet, a vehicle turn-around must be provided, designed to accommodate vehicles having a maximum length of 31-feet and having an outside wheelpath radius of 40-feet. The Director may allow an exception from the turn-around requirement if the access road slope is 8-percent, or less, and the road has a straight alignment.

### **5.3.2 PARKING LOT PONDS**

Parking lot ponds, as well as any pond having a paved bottom (tennis courts, etc.), are a variation on the concept of multi-purpose runoff quantity control facilities. However, because a parking lot is usually a land use permit requirement, it is essential that any secondary design of a parking lot as a runoff quantity control pond be compatible with the parking lot use.

Any parking lot ponds shall be designed to have a maximum depth shallow enough so as not to damage passenger vehicles parked in the pond during flooding. In addition, the bounds of the ponding area shall be limited so as to maintain pedestrian access and to not encroach into established fire access lanes. Paved ponds provide less water quality benefit (biofiltration, biologic activity) than vegetated ponds. Therefore, more stringent water quality measures may be required prior to discharge of stormwater from the project site.

Figure 5-15 BOLLARDS



**NOTES:**

1. TIMBER SHALL BE DOUGLAS FIR, DENSE CONSTRUCTION GRADE, AND SHALL BE PENTACHLOROPHENOL PRESSURE TREATED BY EMPTY CELL PROCESS WITH MINIMUM NET RETENTION OF 0.05 LBS./CU. FOOT OF THE DRY SALT. (USE LIGHT PETROLEUM SOLVENT.)
2. STEEL TUBE SHALL CONFORM TO ASTM A53 OR ASTM A53 GRADE A.
3. NUTS, BOLTS, & WASHERS SHALL CONFORM TO ASTM A307.
4. ALL STEEL PARTS SHALL BE GALVANIZED.
5. CONCRETE SHALL BE CLASS C.

The following are criteria specific to parking lot pond design:

1. The maximum depth of water shall not exceed 0.5-feet at any location in the parking lot.
2. The limits of ponded water at maximum water depth shall not encroach into any established fire lanes or principal ingress/egress lanes.
3. Signs shall be erected adjacent to the parking lot pond area identifying the area as a stormwater detention control area subject to ponding, and identifying the specific parking spaces subject to flooding.
4. The parking lot pond shall be designed so that it will completely drain, leaving no areas of entrapped water in puddles or behind curbs.
5. Overflow control shall be provided on the perimeter of the parking lot pond area, with the flow elevation equal to the design maximum water surface elevation.

### **5.3.3 DETENTION TANKS AND VAULTS**

Tanks are typically constructed of corrugated pipe, whereas vaults are usually constructed of reinforced concrete. Both function to provide underground storage of stormwater as part of a runoff quantity control system.

As with any underground structure, it is important not only that tanks and vaults be designed for their function as runoff quantity control facilities, but also that they be constructed to withstand an environment of periodic inundation, potentially corrosive chemical or electro-chemical soil conditions, and heavy ground surface loadings. Also, they shall be reasonably accessible for maintenance.

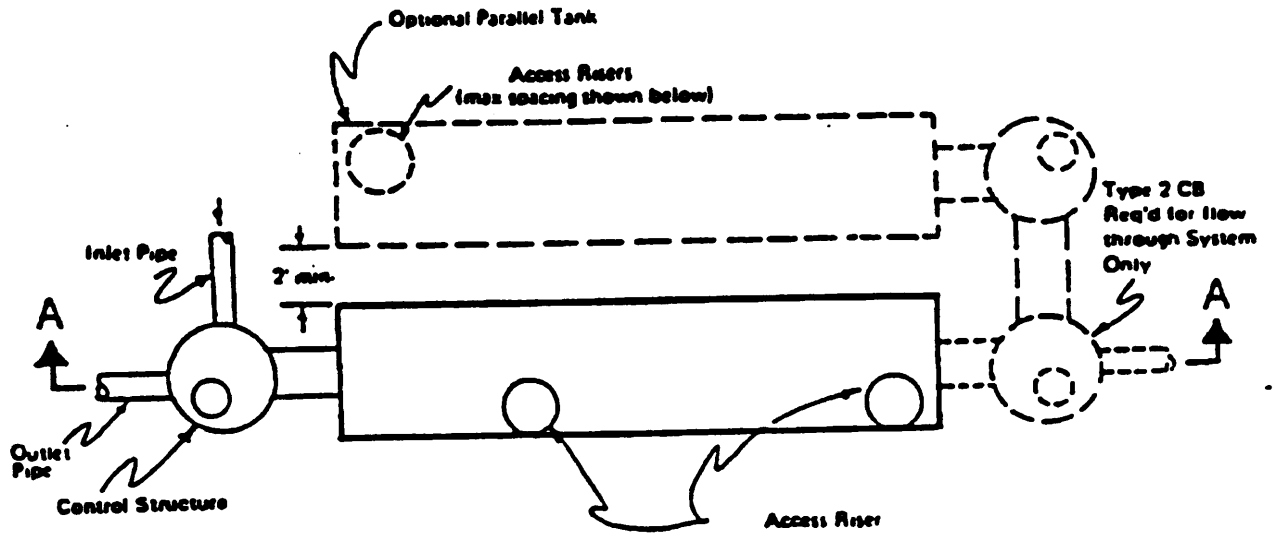
Tanks and vaults provide less water quality benefit (biofiltration, biologic activity) than open ponds. Therefore, more stringent water quality measures may be required prior to discharge of stormwater from the project site.

Tanks and vaults typically do not have a built-in design feature for the containment of sediment, as does the multi-cell pond. For this reason, it will be required that when tanks or vaults are used for detention storage, there either shall be a surface sediment containment pond upstream of the tank or vault, or the tank/vault shall be oversized to allow for the temporary accumulation of sediment in the tank. Where the tank or vault is designed to provide sediment containment, a minimum of 0.5' of dead storage shall be provided and the tank/vault shall be laid flat. See Figures 5-16 and 5-17.

Tanks and vaults can be used in conjunction with other detention storage facilities, such as ponds or parking lot ponds, to provide initial or supplemental storage.

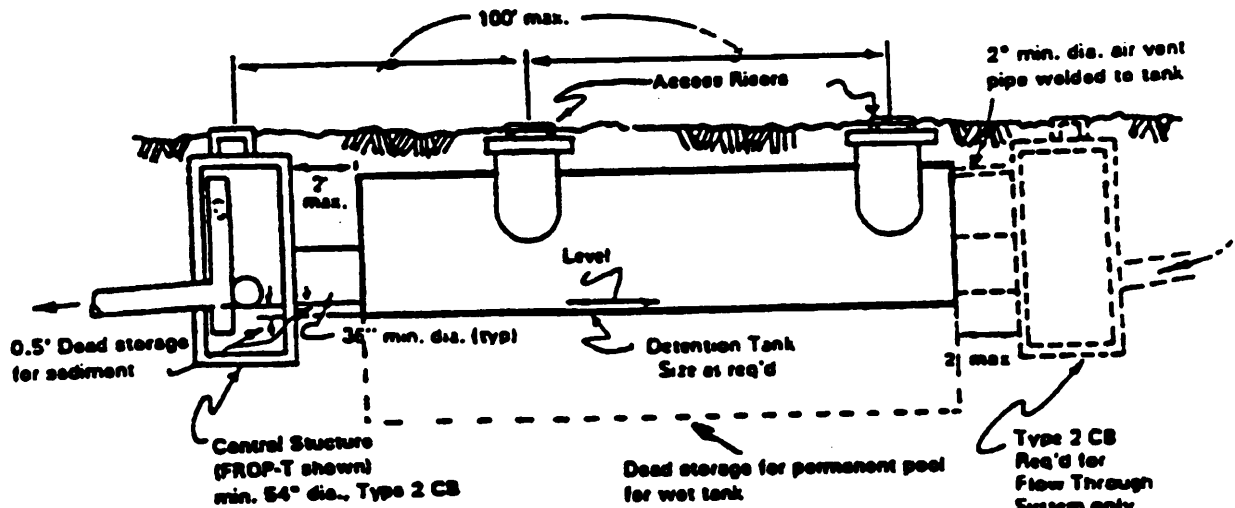


Figure 5-16 DETENTION TANK DETAIL



**Plan View**

*NO SCALE*  
 "Flow Back Up" System Shown  
 Optional Designs for "Flow Through" System and  
 Parallel Tanks Shown Dashed

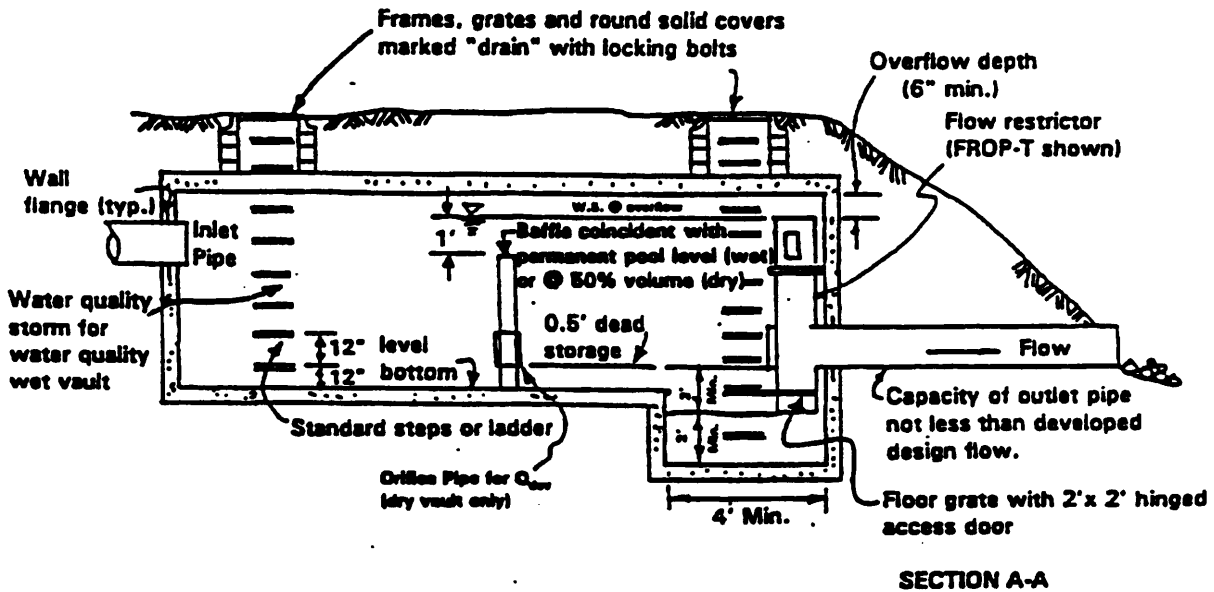
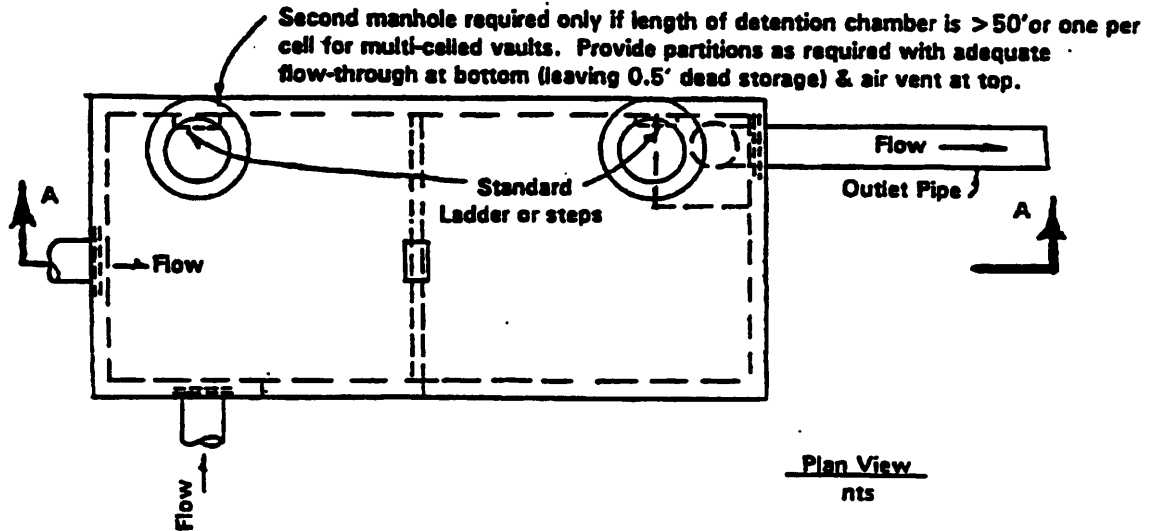


**Section A-A**

*NO SCALE*

**NOTE:** All metal parts corrosion resistant. Steel parts galvanized and asphalt coated (Treatment 1 or better)

Figure 5-17 DETENTION VAULT DETAIL



- Notes:
1. Plans must be designed & stamped by a registered professional structural engineer.
  2. All metal parts shall be corrosion resistant.
  3. Provide water stop at all cast-in-place construction joints. Precast vaults shall have approved rubber gasket system.

The following are criteria specific to detention tank and vault design:

#### **GENERAL DESIGN CRITERIA**

1. Detention tanks and vaults are permitted within public road rights-of-way. For single-family plats and PUD's, detention tanks and vaults not located in public rights-of-way shall be located in separate tracts dedicated to Kitsap County.
2. All tanks and vaults shall be designed as flow through systems unless separate sediment containment is provided.
3. The minimum pipe size for a detention tank is 36". If the collection pipe is designed to also provide storage, the resulting maximum water surface elevation shall maintain a minimum 1 foot of freeboard in any catch basin below the catch basin grate. Pipe capacity shall be verified utilizing backwater analysis as per Chapter 7. Also, pipe material and surface treatment shall conform to the standards for detention tanks.
4. Detention tanks and vaults shall have a minimum of 0.5-feet of dead storage. The bottom of the tank or vault shall be flat.
5. The minimum internal height of a vault or tank shall be 3 feet and the minimum width shall be 3 feet. The maximum depth to the vault invert shall be 20 feet.

#### **MATERIALS & STRUCTURAL STABILITY**

1. Pipe material, joints, and protective treatment for tanks and vaults shall be in accordance with WSDOT/APWA Standard Specifications Section 9.05. All galvanized steel or iron pipe or pipe arch shall have a protective coating of Treatment 1 or greater.
2. All tanks and vaults shall meet structural requirements for overburden support and traffic loading, if appropriate. HS-20 live loads shall be accommodated for tanks and vaults lying under roadway or parking areas. Metal tank end plates shall be designed for structural stability at maximum hydrostatic loading conditions. Flat end plates generally require thicker gage material than the pipe and/or require reinforcing ribs. Tanks and vaults shall be placed on stable, well consolidated native material with a suitable bedding. Tanks and vaults shall not be allowed in fill slopes, unless analyzed in a geotechnical report for stability and construction practices.
3. Detention Vaults shall be constructed of minimum 3000 psi structural reinforced concrete. All construction joints shall be provided with water stops. All vaults shall be designed by a qualified structural engineer. Structural designs for cast-in-place vaults require a separate commercial building permit issued by the Kitsap County Department of Community Development. Vaults shall be placed on stable, well consolidated native

material with suitable bedding. Vaults shall not be allowed in fill slopes, unless analyzed in a geotechnical report for stability and construction practices.

4. In moderately pervious soils where seasonal groundwater may induce flotation, buoyancy tendencies shall be balanced by ballasting with earth backfill or concrete backfill, by providing concrete anchors, by increasing the total weight, or by providing subsurface drains to permanently lower the groundwater table. Calculations may be required which demonstrate stability.

#### ACCESS

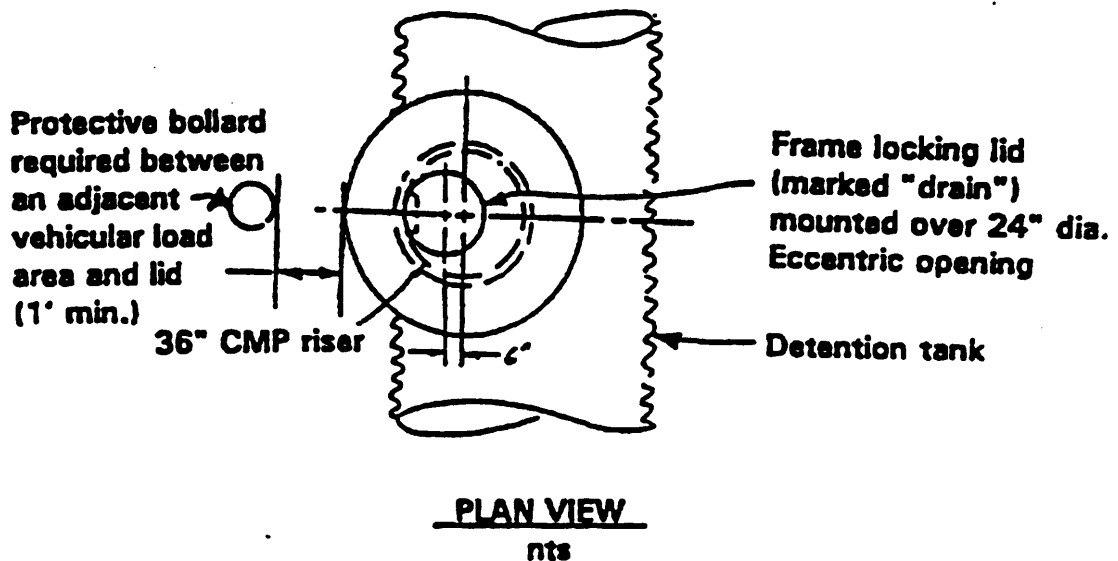
1. All areas of the vault shall be within 50-feet of a minimum 36-inch diameter access cover. A ladder to the bottom of the vault may be required.
2. CMP access risers: Outside of any areas subject to vehicular loads, 36-inch minimum diameter CMP access risers of the same gage as the tank material may be used for access along the length of the tank and at the upstream terminus of the tank if the tank is designed with a common inlet/outlet so that it is a backup system rather than flow through system. The Director may allow risers in traffic areas with an appropriate traffic bearing design. See Figure 5-18 for details.

All risers are required to have solid lids.

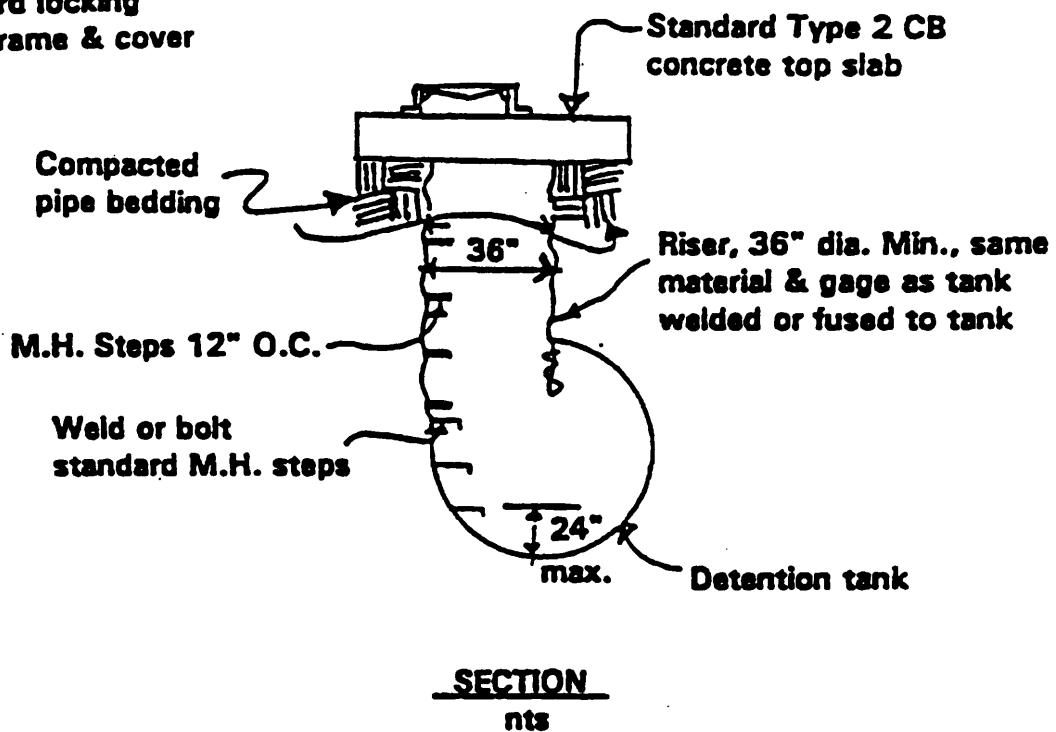
3. All tank and vault access openings shall have round, solid, locking lids using ½" diameter allen head screw locks (See Figure 5-19).
4. Conveyance pipes shall not be permitted to connect directly to detention tanks.
5. Access roads are required to all detention tank and vault access openings and control structures not located in improved public rights-of-way. The access roads shall meet the requirements for access roads for ponds described previously.

Figure 5-18 DETENTION TANK ACCESS RISER

**Restrictions for application: use only for access to detention tanks. Not allowed for use in roadways, driveways, parking stalls or where vehicular loads would occur.**



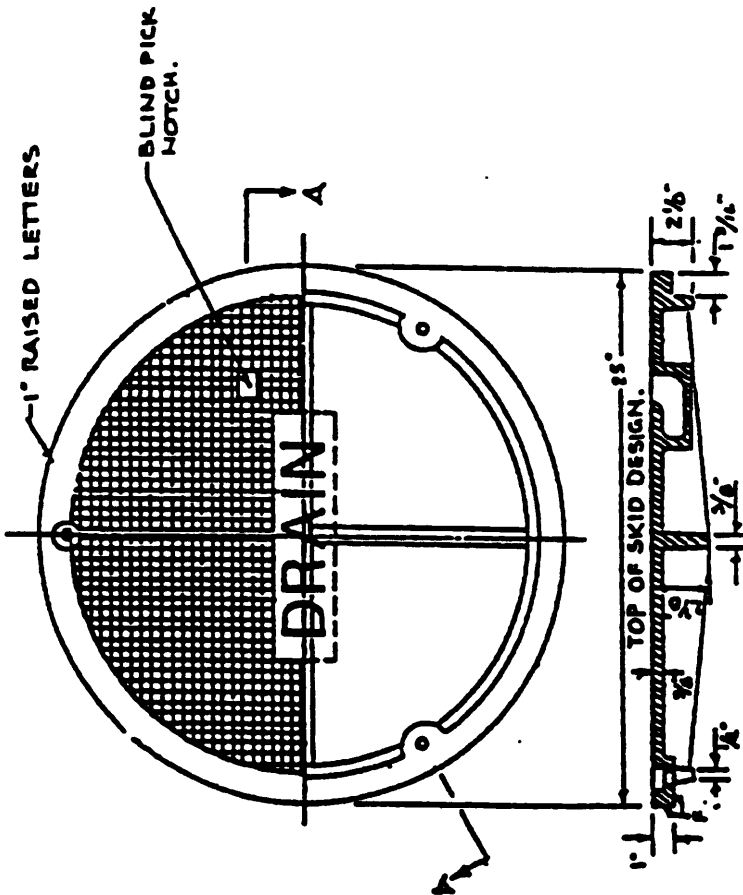
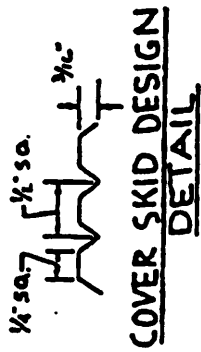
Standard locking  
M.H. Frame & cover



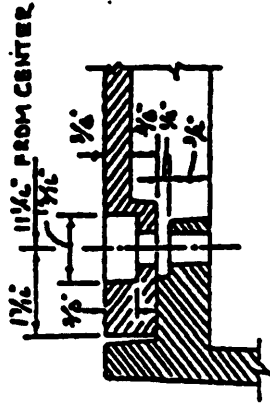
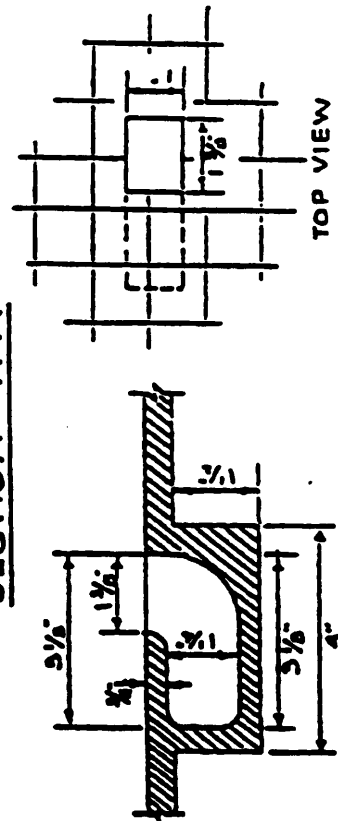
**Notes:**

1. Use adjusting blocks as required to bring frame to grade.
2. All materials must be corrosion resistant.
3. Must be conveniently located for maintenance vehicle access.

Figure 5-19 SOLID LOCKING LID



SECTION A-A



- NOTES
1. USE WITH THREE LOCKING BOLTS  
 $\frac{3}{8}$ "-11 NC STAINLESS TYPE 304  
 STEEL SOCKET HEAD (ALLEN HEAD)  
 CAP SCREWS 2" LONG. DRILL  
 HOLES SPACED 120° AT  $1\frac{1}{2}$ " RADIUS.
  2. MATERIAL IS DUCTILE IRON ASTM  
 A 55C GRADE 60-55-06.

SOLID LOCKING LID/ALLEN HEAD SCREW  
 LOCKS

### 5.3.4 CONTROL STRUCTURES

Detention control structures may be either weir structures or orifice structures. Weir structures may be either enclosed in a catch basin or vault, or they may be installed in the open, provided that they are accessible for maintenance and are not exposed to damage.

All detention control facilities shall provide oil/water separation prior to discharge. This can be accomplished by incorporating oil/water separation into the design of the control structure (e.g. utilizing a FROP-T device in a Type 2 catch basin) or by installing a separate spill containment (SC) oil/water separator vault. Oil/water separation measures are required for control of storms up to the 100-year 24-hour design storm.

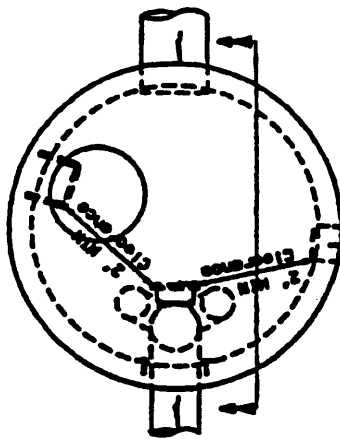
#### CONTROL STRUCTURE DESIGN CRITERIA

1. Flow control manholes shall have solid locking covers. Open grates shall not be permitted in control manholes.
2. Multiple orifices are usually necessary in order to meet the 2-year, 10-year and 100-year performance requirements for a detention system. Usually, no more than 2 orifices will be necessary in order to achieve the required performance. However, high flow rates may result in excessively large orifice sizes that are impractical to construct. In such cases, several orifices may be located at the same elevation to reduce the size of each individual orifice.
3. Orifices may be constructed on a "Tee" riser section as shown in Figure 5-20 or on a baffle as shown in Figure 5-21.
4. When it is required that the release rate from a 2 year, 24-hour storm event be limited to 50% of the pre-development 2-year release rate, there may be instances where the 2-year water surface elevation is too high to physically construct an upper orifice above the 2-year storage elevation. In such an instance, a notch weir in the riser pipe may be used to meet performance. See Figure 5- 22 for design and sizing criteria.
5. Where flow control is provided using weir control rather than orifice control, an alternative method shall be used for providing oil/water separation. Either an oil/water separation baffle shall be installed (see Figure 5- 22), or a separate oil/water separation structure shall be provided.

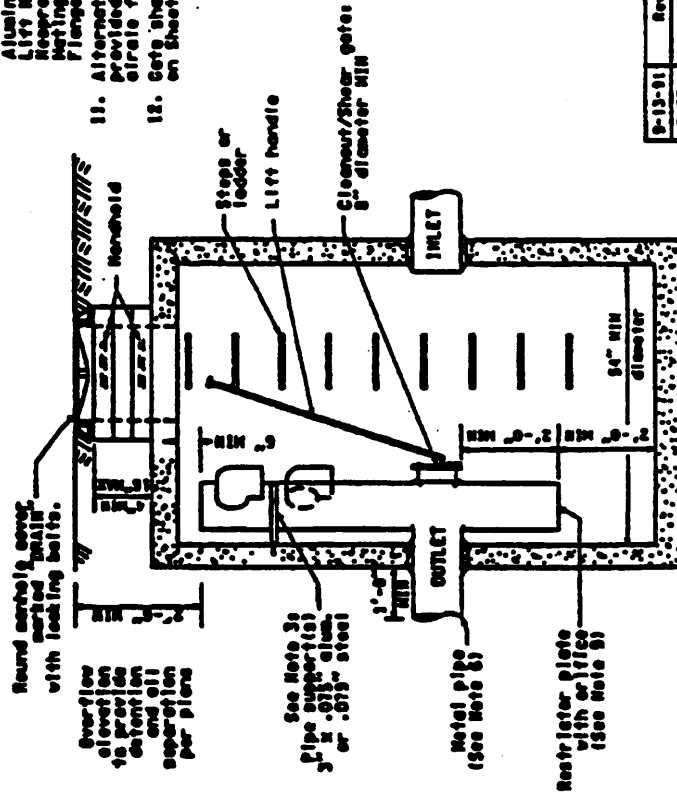
Figure 5-20 ORIFICE LOCATION - TEE RISER

- NOTES**
- Except as shown or noted, units shall be constructed in accordance with the requirements for Catch Basin Type 2, 3" aluminum diameter.
  - For details showing Grade Ring, Ladder, Steps, Handholds, and Top Slabs, see Standard Plan "Miscellaneous Catch Basin Details".
  - Pipe supports and restrictor/separators shall be of the same material, and be anchored at 3' MAX spacing by  $\frac{3}{8}$ " DIA stainless steel expansion bolts or embedded 2" in wall.
  - The restrictor/separator shall be fabricated from 90° aluminum, or 6061 aluminum steel, or 304 galvanized steel pipe, in accordance with ASTM A 36, A 196, A 197, and A 214. Galvanized steel shall have treatment 1.
  - Outlet shall be connected to culvert or sewer pipe with a standard coupling band for corrugated metal pipe, or grouted into the bell of concrete pipe.
  - The vertical riser side of the restrictor/separator shall be the same diameter as the horizontal outlet pipe, with an 8" aluminum diameter.
  - Frams and ladder or steps are to be offset so that:
    - Clearout gate is visible from top.
    - Climb-down space is clear of riser and gate.
    - Frams is clear of curb (if dry catch).
  - Multi-orifice elbows may be located as shown or all on one side of riser to ensure ladder clearance. Size of elbows and placement to be determined by the Engineer.
  - Restrictor plate with orifice as specified in the contract plans. Bolt plate 14 for oil pollution control only. Specified spacing to be cut round and smooth.
  - Clearout/Shear gates:
 

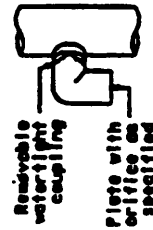
Aluminum alloy per ASTM B-26-26 or cast iron ASTM A48 Class 305 as required. Lift handle either solid or tubing with adjustable heat as required. Keepers rubber gasket required between riser mounting flange and gate flange. Keeling surfaces of lid and body to be machined for proper fit. Flange mounting bolts shall be  $\frac{3}{8}$ " DIA stainless steel.
  - Alternate clearout/shear gates to the design shown on sheet 2 are acceptable, provided they meet the material specifications above and have a 6" belt, 10  $\frac{1}{2}$ " belt circle for biting to the flange connection.
  - Gates shall not open beyond the clear opening as shown on "Max Opening of Gate" on sheet 1, by limited hinge movement, stop tab, or some other device.



PLAN VIEW



SECTION A - A



ELBOW DETAIL

**CATCH BASIN TYPE 2 WITH FLOW RESTRICTOR - OIL SEPARATOR**

DESIGNED BY: *[Signature]*

DATE: 5-13-91

STANDARD PLAN B-3

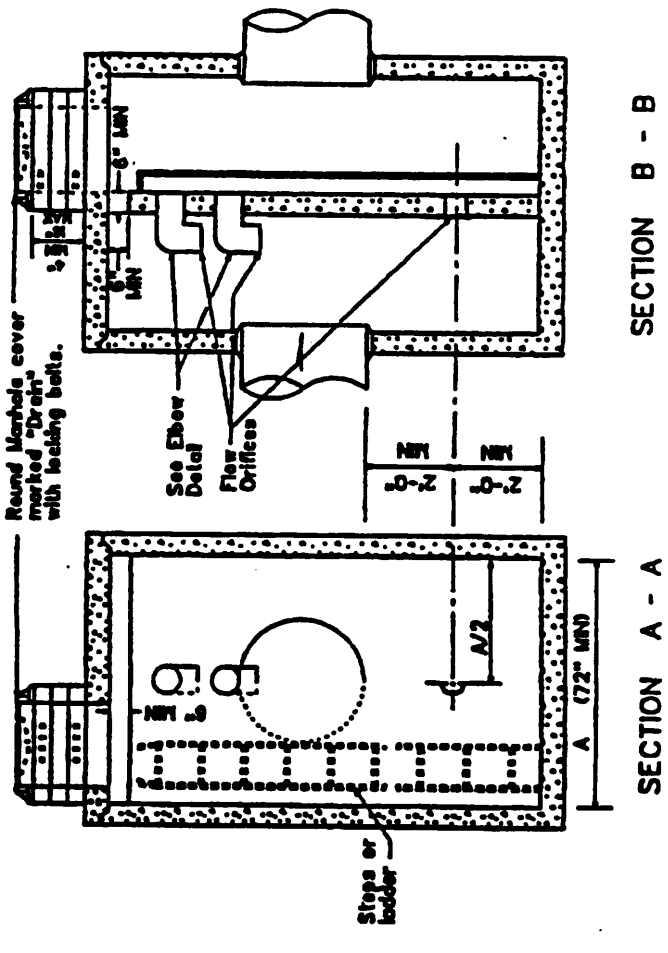
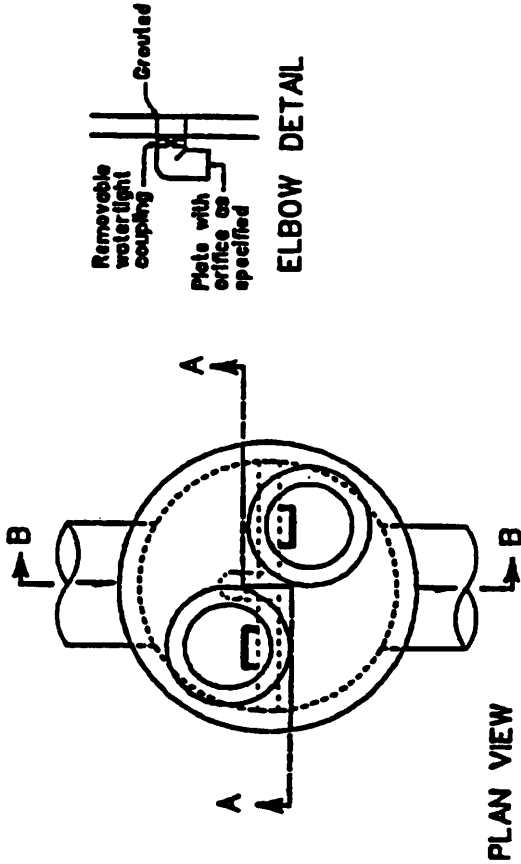
Sheet 1 of 2 sheets

DATE	REVISED NOTES, ELBOW DETAIL	BY	APPROVED
5-13-91			
	REVISION		



Figure 5-21 ORIFICE LOCATION - BAFFLE RISER

- NOTES**
1. Except as shown or noted, units shall be constructed in accordance with the requirements for Catch Basin Type 2, 72" & 98".
  2. For details showing Creds. ring, Ladder, Steps, Handholds and Top slabs, see Standard Plan "Miscellaneous Catch Basin Details".
  3. See Contract Plan for size and location of all orifices.
  4. Pipe sizes, slopes and all elevations as shown in the plans.
  5. Baffle wall shall have #4 bar at 12" spacing each way.
  6. Precast baffle wall shall be keyed and grouted in place.
  7. Bottom orifice plate to be 1/4" minimum galvanized steel and attached with 1/2" stainless steel bolts. Omit orifice plate if only for oil separation.
  8. Upper flow orifice shall be aluminum, aluminumized steel or galvanized steel (see Standard Plan "Catch Basin Type 2 With Flow Restrictor - Oil Separator"). Galvanized steel shall have Treatment L.



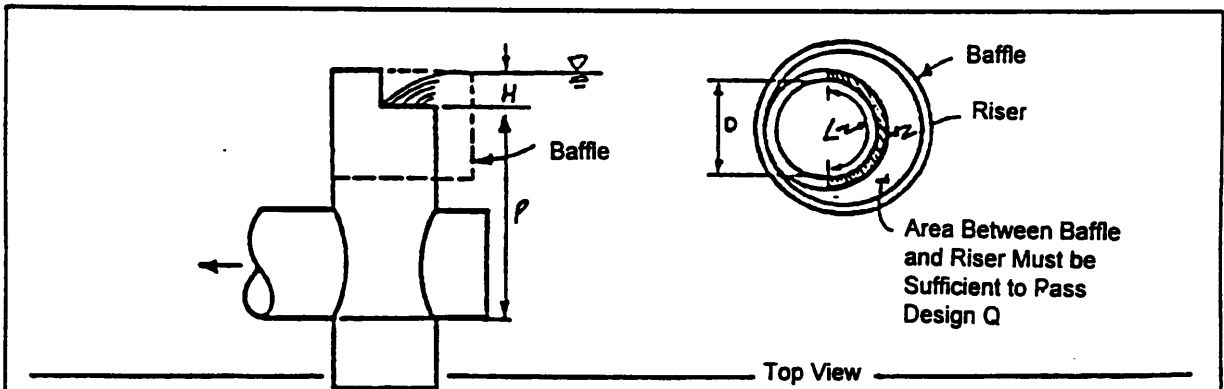
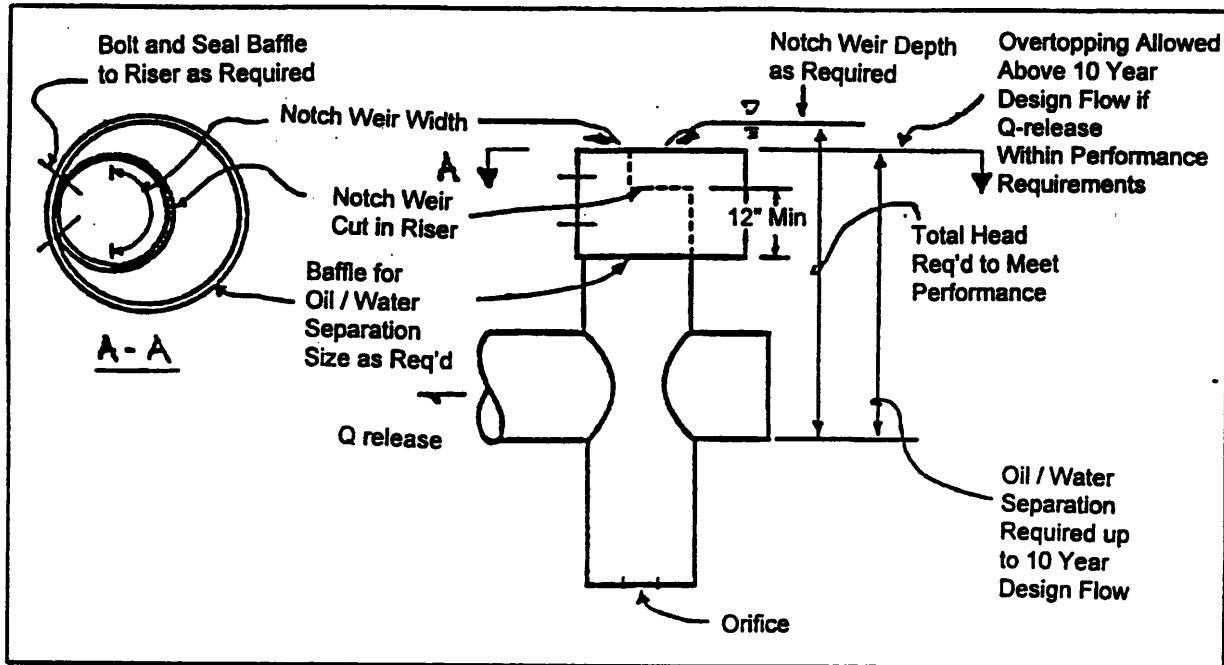
**CATCH BASIN  
TYPE 2 WITH  
BAFFLE TYPE  
FLOW RESTRICTOR -  
OIL SEPARATOR**

INDICATED WITH APPROVAL OF TRANSPORTATION  
ENGINEER

DESIGNED BY  
ENGINEER CONSULTANT FOR PUBLIC UTILITIES  
FUNDING NUMBER 10, 1960

**STANDARD PLAN B-30**

Figure 5-22 TEE SECTION WITH NOTCH WEIR & BAFFLE



Side View

Top View

$$Q = C(L - 0.2H)H^{3/2} cfs$$

where

C =  $3.27 + 0.40 H/P$  (in feet).

L = Length of the portion of the riser circumference as necessary (in feet), not to exceed 50% of the circumference.

H&P as shown above

D = Inside riser diameter.

Note that to account for side contractions, subtract 0.1 H from L for each side of the notch weir.

**Notch Weir**

6. Properly designed weirs, such as rectangular notched weirs, v-notched weirs, or suture weirs, may be used as flow restrictors located either in catch basin structures, or mounted on a concrete retaining structure in the open. Formulas for sizing rectangular notched weirs and v-notched weirs are as follows:

**RECTANGULAR NOTCHED, SHARP CRESTED WEIR**

$$Q = C(L - 0.2H)H^{\frac{3}{2}}$$

where: Q = Weir discharge, in cubic feet per second  
 C = 3.27 + 0.40 H/P, in feet  
 P = Height of weir bottom above downstream water surface  
 in feet  
 H = Height from weir bottom to crest, in feet  
 L = Length of weir, in feet\*

\*For weirs notched out of circular risers, Length is the portion of the riser circumference, not to exceed 50% of the circumference.

**V-NOTCH, SHARP CRESTED WEIR**

$$Q = C_d \left( \tan \frac{\theta}{2} \right) H^{\frac{5}{2}}$$

where: Q = Weir discharge, in cubic feet per second  
 C<sub>d</sub> = Contraction coefficient, in feet\*  
 θ = Internal angle of notch, in degrees  
 H = Height from weir bottom to crest, in feet

\* C<sub>d</sub> values may be taken from the following chart:

7. The control structure shall be designed to pass the 100-year, 24-hour duration storm event as overflow without causing flooding of the contributing drainage area and without allowing runoff to discharge through the emergency overflow spillway.

### **5.3.5 RETENTION FACILITIES**

The most common retention facilities used in Kitsap County are retention ponds and trenches. Both facilities are designed to store runoff while allowing it to infiltrate into the native soils.

Underground infiltration trench systems are highly susceptible to failure by the reduction in infiltration capacity caused by the plugging of the infiltration surface with sediment and/oily substances, as well as plugging resulting from improper construction practices. Ordinary maintenance usually cannot restore the infiltration function, and when failure occurs the entire system usually requires replacement. Because of the risk involved, these systems shall remain private and it will be the responsibility of the property owner to provide maintenance and to bear the cost of repair or replacement of the system. Infiltration trenches will not be allowed for use in residential developments unless a deviation from this requirement is granted by the Director.

Infiltration ponds are allowed for use in all types of developments. The basic requirements for infiltration ponds are the same as for detention ponds, with other specific criteria noted below.

In general, the setback, overflow and safety requirements for detention facilities also apply to infiltration ponds and trenches.

### **SOILS IDENTIFICATION AND DETERMINATION OF INFILTRATION RATE**

Projects considered for on-site stormwater retention systems are required to provide soil classification information verifying the infiltration capability of site soils. A Soils Report is required for the location of each infiltration system proposed. The report shall include a Particle-Size Analysis performed by ASTM Test Method D-422-63. One sample for every 5,000-sf of infiltrating surface area is required to be obtained from the location of the proposed system, at a point 36-inches below the infiltration surface. Test results, including certification of the sample location and the depth to seasonal high groundwater table, shall bear the seal of a licensed professional engineer who has recognized expertise in the classification and mechanics of soils. The analysis will be used as the basis for determining the USDA Textural Classification.

The soil infiltration rate used for final design shall conform to Table 5-4 utilizing a factor of safety of 2.0.

Soils with an infiltration rate of less than 0.5-inches per hour are generally considered unsuitable for streambank erosion control. Infiltration systems shall not utilize fill material, nor be placed over fill soils.

#### **DESIGN CRITERIA FOR INFILTRATION TRENCHES AND PONDS**

The following design criteria apply specifically to ponds and trenches designed to infiltrate all or a portion of runoff (retention):

1. All ponds and trenches utilizing infiltration shall be designed using an appropriate storage routing method.
2. Facilities utilizing infiltration shall have bottoms a minimum of 18-inches above seasonal high ground water.
3. All retention facilities shall be a minimum of 200-feet from any slope steeper than 30%. This distance may be reduced based on a geotechnical engineering report.
4. All stormwater, prior to discharge to a facility designed to utilize infiltration, shall pass through a designed biofiltration swale system and through a presettling basin. In addition, all stormwater from paved areas subject to motor vehicle traffic shall flow through a spill-containment type oil/water separator.
5. For runoff quantity control facilities utilizing infiltration, those facilities shall be designed for a 100-year, 7-day storm event and also for a 100-year, 24-hour storm event, and shall have a maximum draw down time of 48-hours.
6. Until all project improvements which produce surface runoff are completed and all exposed ground surfaces are stabilized by revegetation or landscaping, facilities utilizing infiltration may not be operated, and no surface runoff may be permitted to enter the system.
7. The soil infiltration rate used for the design of infiltration systems shall be based on a textural analysis, according to Table 5-4. A safety factor of 2 shall be applied to the infiltration rate.

**Table 5-4 SOIL INFILTRATION RATES BASED ON TEXTURAL ANALYSIS**

<b>SOIL TEXTURE CLASS</b>	<b>INFILTRATION RATE</b>
1. Gravel, coarse sand	1 min/inch
2. Sand	5 min/inch
3. Loamy sand	15 min/inch
4. Sandy loam	30 min/inch
5. Loam	Unsuitable

### RETENTION PONDS

- o Infiltration ponds can be open or be lined with a 6 to 12-inch layer of filter material such as coarse sand or a suitable filter fabric to help prevent the buildup of impervious deposits on the soil surface. The filter layer can be replaced or cleaned when/if it becomes clogged.
- o Establishing a healthy stand of vegetation on the pond side slopes and floor is recommended. This vegetation will not only prevent erosion and sloughing, but will also provide a natural means of maintaining relatively high infiltration rates. Erosion protection of inflow points to the basin shall also be provided. Removal of accumulated sediment is a problem only at the basin floor. Little maintenance is normally required to maintain the infiltration capacity of side slope areas.

### INFILTRATION TRENCHES

1. Trenches shall be designed to utilize infiltration through the bottom only, without taking into account sidewall infiltration. Storage volume shall be based on a maximum 30% void ratio for drainrock.
2. There is no minimum spacing between trench center lines and no maximum trench width. However, flow distribution lines shall be installed at a spacing of 10-feet or less between pipes.

3. A Type 2 catch basin with sump (see Figure 5-23) shall be located on the upstream end of the trench, which provides a minimum of 36-inches of depth below the invert of the outlet pipe. A FROP-T device shall be provided on the outlet to the trench as shown on the detail. Additional Type 2 catch basins shall be placed along the trench to provide cleanout access such that all portions of the trench are within 150 feet of a catch basin.
4. An observation well (see Figure 5-24) shall be installed adjacent to the infiltration trench and within 25-feet of the facility for the purpose of monitoring ground water conditions. The observation well should consist of perforated PVC pipe, 6- inches in diameter, backfilled with the same clean gravel material used in the infiltration trench. It should be located in the center of the structure and be constructed flush with the ground elevation of the trench. The top of the well should be capped to discourage vandalism and tampering.
5. The aggregate material for the infiltration trench shall consist of a washed aggregate free of fines with a maximum diameter of 1-1/2-inches and a minimum diameter of 3/4-inches.
6. A geotextile material shall be placed over the top of the trench to prevent backfill material from contaminating the washed rock.

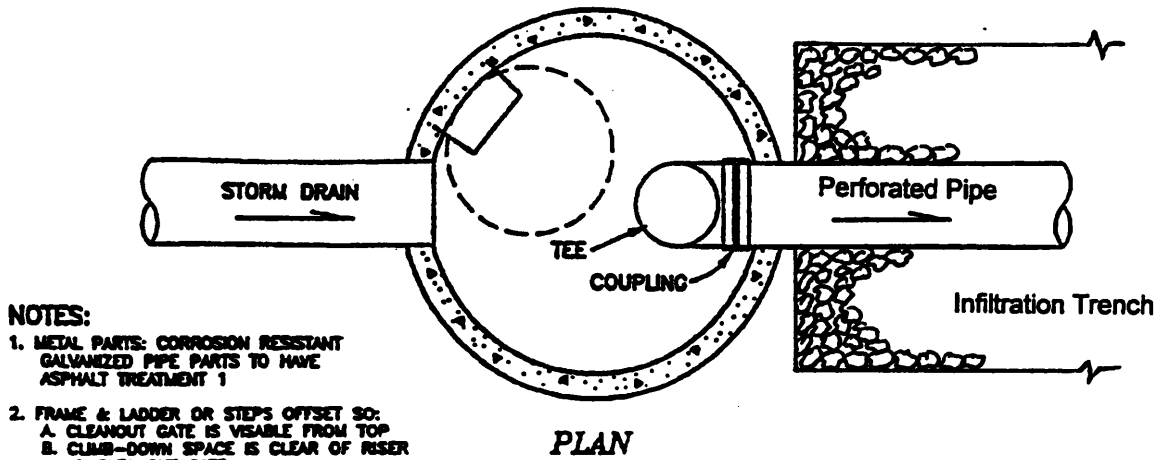
### **5.3.6 INDIVIDUAL DOWNSPOUT INFILTRATION SYSTEMS**

Individual downspout infiltration systems are trench infiltration systems designed to receive only stormwater from roof downspout drains. They shall be designed so as not to receive surface water from paved areas. Also, a single individual downspout infiltration system can only serve a maximum of 5000 square feet of roof area.

The following standardized design criteria is intended to guide the homeowner in providing an acceptable design for an individual downspout infiltration system. Deviation in design or construction from the standardized design criteria detailed below may require design by a qualified engineer. This will be left to the discretion of the Director.

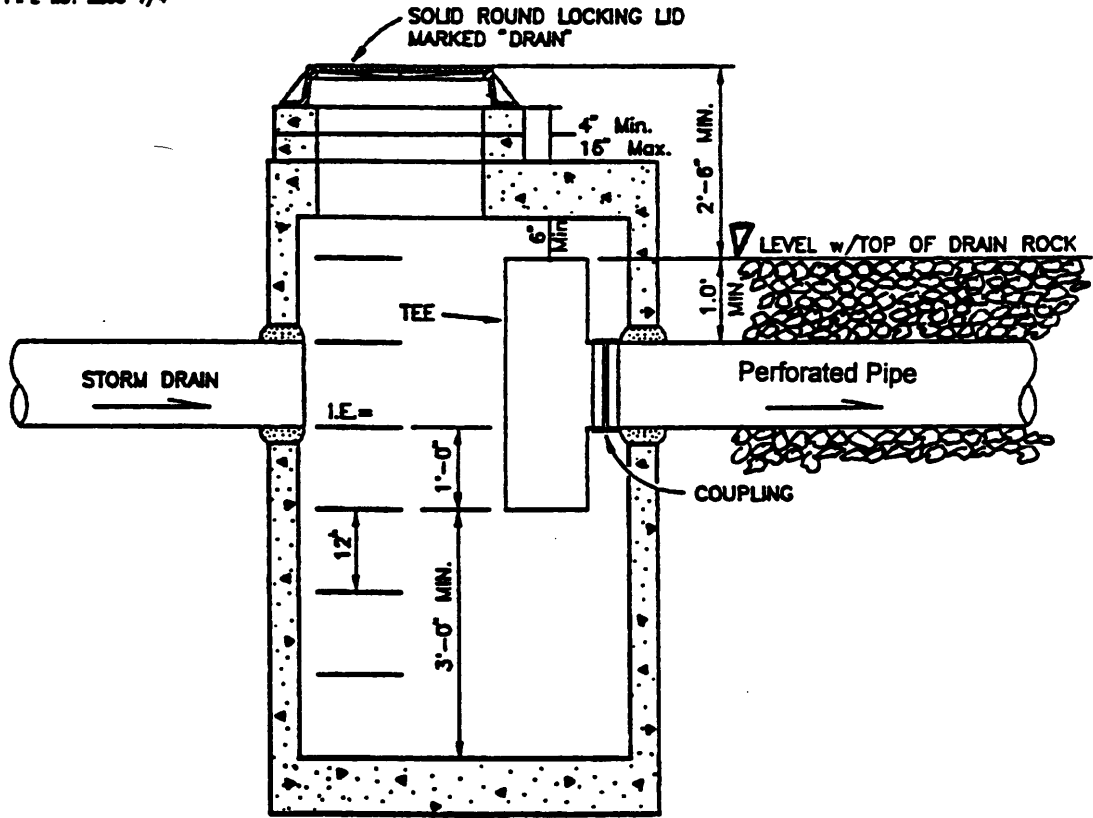
1. Individual downspout infiltration systems will not normally require design by a civil engineer provided that: 1) the proposed site development does not result in a net increase in impervious surfaces of more than 5,000 square feet; 2) the system is sized according to the sizing chart shown in Table 5-5; and 3) the system is constructed according to the standard design shown in Figure 5-25.
2. Prior to approval of an individual downspout infiltration system, a site plan shall be submitted showing the location of the proposed infiltration system together with adjacent building structures, wells, septic drainfields and tanks, curtain drains, and property lines.

Figure 5-23 TYPE 2 CATCH BASIN SUMP - INFILTRATION TRENCH



**NOTES:**

1. METAL PARTS: CORROSION RESISTANT GALVANIZED PIPE PARTS TO HAVE ASPHALT TREATMENT 1
2. FRAME & LADDER OR STEPS OFFSET SO:
  - A. CLEANOUT GATE IS VISABLE FROM TOP
  - B. CLIMB-DOWN SPACE IS CLEAR OF RISER & CLEANOUT GATE
3. IF METAL OUTLET PIPE CONNECTS TO CEMENT CONCRETE PIPE: OUTLET PIPE TO HAVE SMOOTH O.D. EQUAL TO CONCRETE PIPE I.D. LESS 1/4"



**ELEVATION**

**Infiltration Catch Basin  
Type II - 48"  
NTS**



Figure 5-24 OBSERVATION WELL

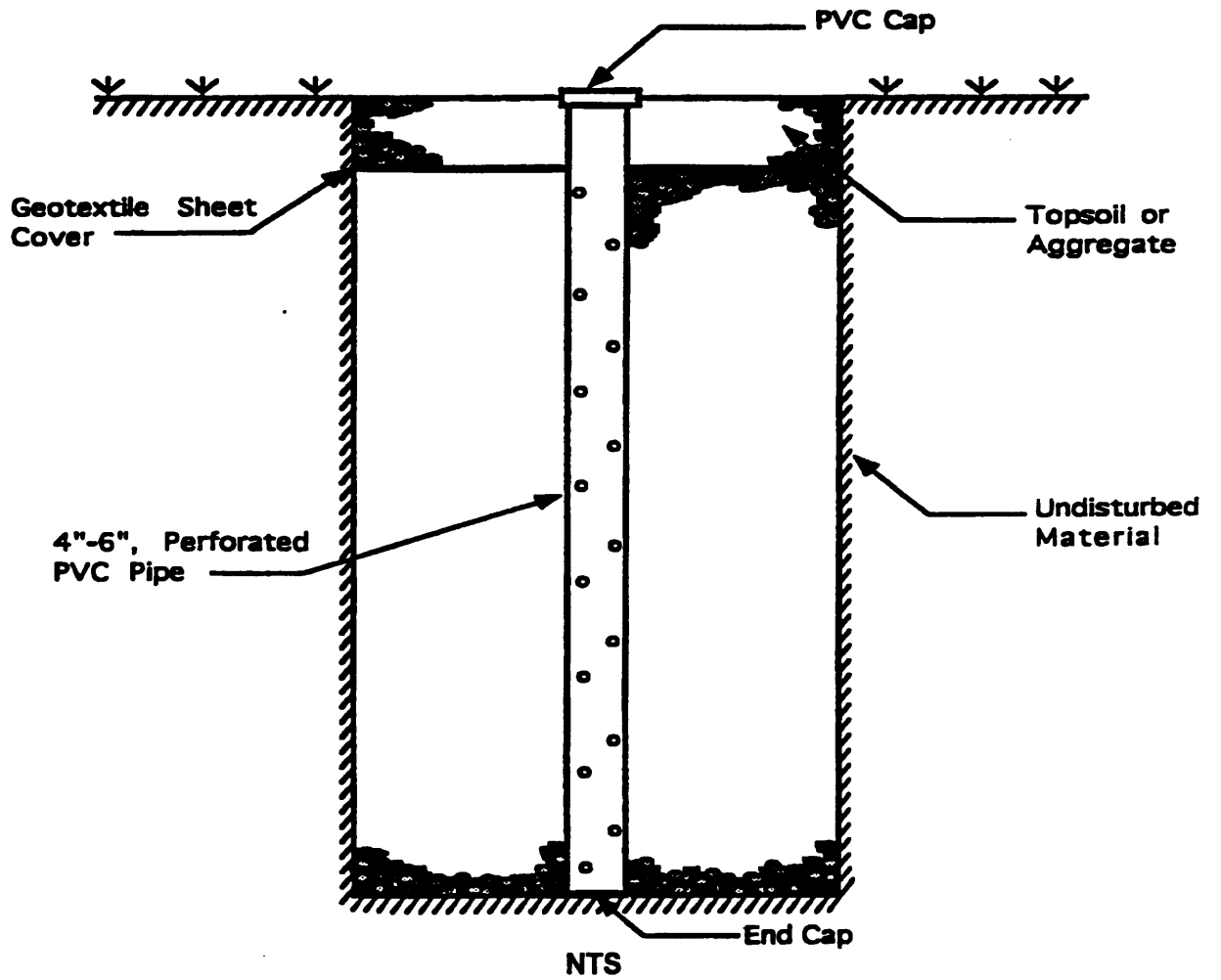
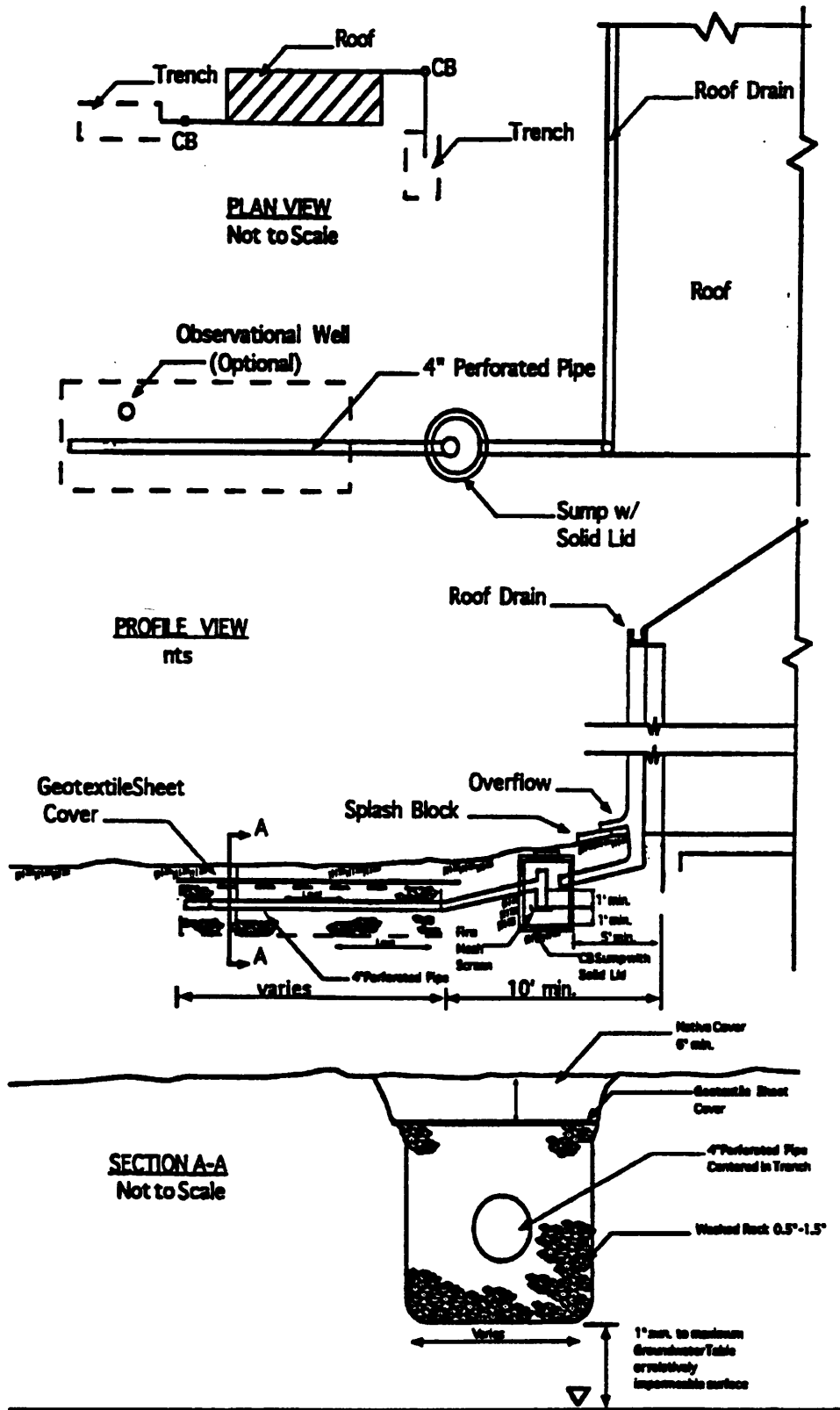


Figure 5-25 INDIVIDUAL DOWNSPOUT INFILTRATION SYSTEM



**Table 5-5 INDIVIDUAL DOWNSPOUT INFILTRATION SIZING CHART  
(SQUARE FEET OF TRENCH BOTTOM)**

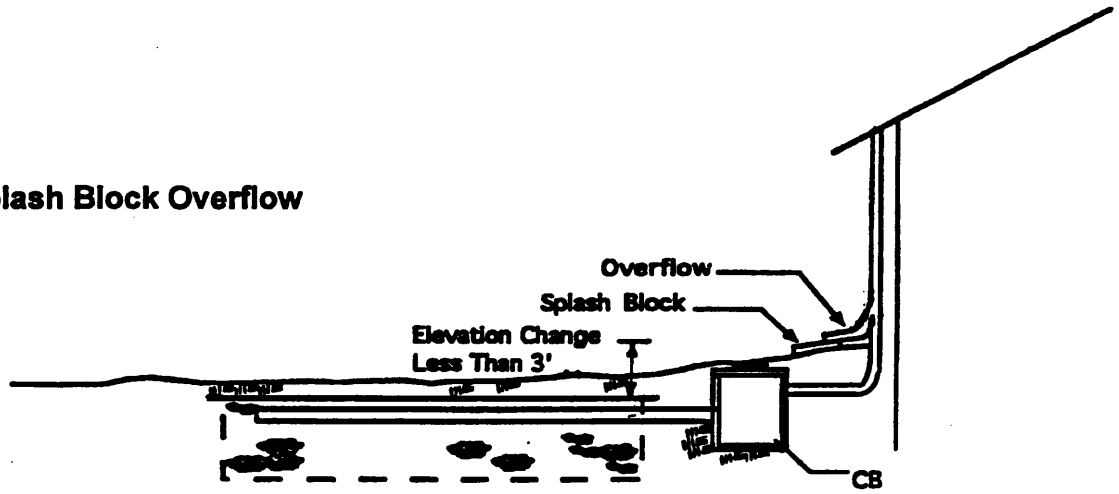
COARSE - MEDIUM SAND (5 MIN/IN)			
GRAVEL DEPTH	ROOF AREA		
	3000 SF	4000 SF	5000 SF
1'	247	330	412
1.5'	203	271	339
2'	175	233	291
2.5'	154	206	257
3'	139	185	231
FINE - LOAMY SAND (15 MIN/IN)			
GRAVEL DEPTH	ROOF AREA		
	3000 SF	4000 SF	5000 SF
1'	416	554	692
1.5'	323	431	539
2'	268	357	446
2.5'	230	306	383
3'	202	269	336
SANDY LOAM, LOAM (30 MIN/IN)			
GRAVEL DEPTH	ROOF AREA		
	3000 SF	4000 SF	5000 SF
1'	535	713	891
1.5'	403	538	672
2'	327	436	544
2.5'	276	368	460
3'	240	320	399

\*Roof areas less than 3000 sf shall be designed for 3000 sf unless otherwise approved by the Director.

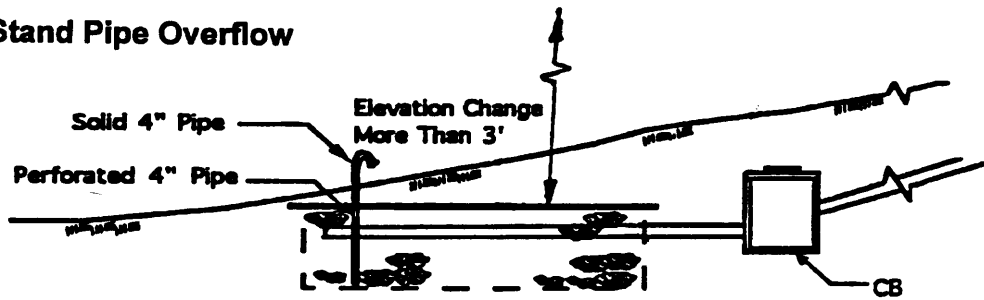
3. All trenches shall be a minimum of 5 feet from any property line, 10 feet from any structure, 30 feet downslope or 100 feet upslope from any septic drainfield, 15 feet downslope or 50 feet upslope from any septic tank, 10 feet downslope or 30 feet upslope of any curtain drain, 50 feet from private wells and 100 feet from public wells. Greater setbacks may be required by the Bremerton Kitsap County Health District (BKCHD) or the Director.
4. All trenches shall be a minimum of 50 feet from any slope steeper than 45%. This distance may be reduced based on a geotechnical engineering report.
5. There is no minimum spacing between trench center lines and no maximum trench width. However, flow distribution lines shall be installed at a maximum spacing of 10 feet or less between pipes.
6. Trench length shall not exceed 100 feet from the inlet sump.
7. A minimum of one soil log shall be obtained for each proposed individual downspout infiltration system. The soil log shall extend a minimum of 18" below the bottom of the trench, describe the USDA textural class of the soil horizon through the depth of the log, and note any evidence of high groundwater level, such as mottling.
8. Trench bottoms shall be a minimum of 12 inches above seasonal high ground water or relatively impervious layer.
9. Geotextile filter fabric shall be placed on top of the drain rock prior to backfilling.
10. A catch basin inlet sump (See Figure 5-25) shall be located upstream of the trench, which provides a minimum of 24" of depth below the invert of the outlet pipe. The outlet tee shall be designed so as to be submerged at all times, and a screening material shall be installed on the pipe outlet.
11. An overflow device is required for all downspout infiltration systems. Examples are given in Figure 5-26. In situations where the elevation difference between the bottom of the downspouts and the top of the infiltration bed is less than 3 feet, the overflow device may be as simple as an elbow on the downspout pipe. Where elevation differences exceed 3 feet, the overflow must be placed at the observation well or catch basin near the bed itself. Alternatively, the overflow device may be deleted if the washed gravel is extended to the ground surface, allowing runoff to flow out the top in the event of overflow.
12. An observation well (see Figure 5-24) is recommended, but not required. The observation well allows the homeowner to monitor the performance of the facility.
13. Following completion of construction of a downspout infiltration system, an "as-built" drawing of the infiltration system shall be submitted to Kitsap County.

Figure 5-26 OVERFLOW DEVICES

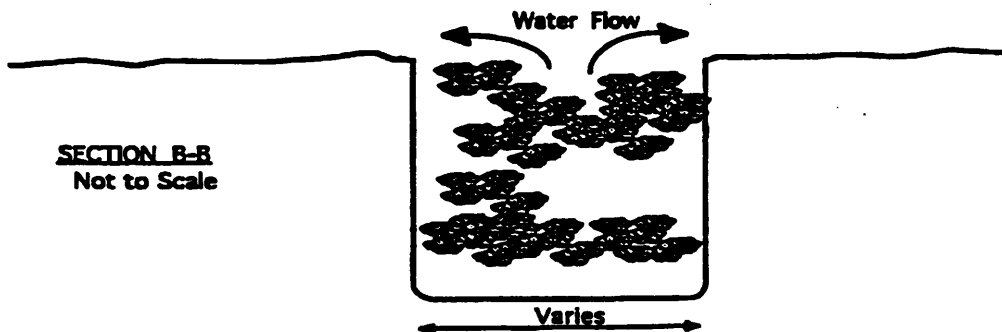
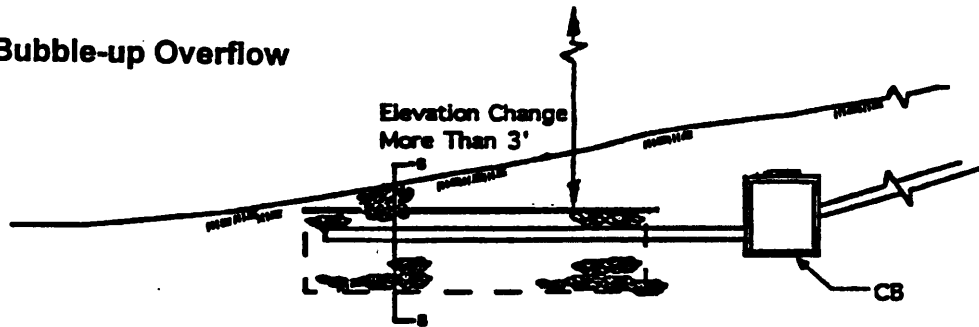
### Splash Block Overflow



### Stand Pipe Overflow



### Bubble-up Overflow





## **APPENDIX 5A**

### **RURAL RESIDENTIAL MAJOR DEVELOPMENTS**





**Single Family Dwelling Projects that Meet the Major Development Definition**

For those sites contained within the residential zoning areas outside of the urban growth areas of unincorporated Kitsap County. (Forest Resource Lands, Interim Rural Forest, Rural Protection Zone, Rural Residential Zone, Urban Reserve Zone) that are used for residential purposes (Single Family Dwellings, Duplexes, Accessory Dwelling Units, Non-commercial Accessory Use Buildings and other like uses allowed under title 17 of the Kitsap County Code) that meet the definition of a major development as defined in title 12 of the Kitsap County Code (or are required to submit an engineered drainage plan as a condition of land subdivision) the following design alternatives apply:

**5A.0.0 Design Criteria**

**5A.0.1 Path A:**

Design and install either a retention or detention system per the guidelines found in chapter 5 of this manual. The minimum plan submittal requirements are found in this appendix. (SFR SDAP Plan Checklist, SFR Drainage Report)

**5A.0.2 Path B:**

Design and install pre-engineered system per the criteria listed below:

- 1) Stormwater runoff from all impervious surfaces shall be routed to an infiltration system that conforms to the pre-engineered systems listed in tables 5-8 through 5-18. A maximum of 10% of a driveway may bypass the infiltration system due to topography constraints. This bypass runoff must be dispersed per section 5A.2.0.
- 2) All landscaped areas shall incorporate composted soil amendments to a depth of 12” at the application rate designated in Table 5-6.
- 3) All landscaped areas shall be graded to drain runoff as dispersed sheet flow through native vegetation areas that meet the criteria below:
  - a. All soil types: Any required native vegetation retention areas shall be shown on a site plan that will be recorded along with the model covenant contained in this appendix.
  - b. Soil Type A: Minimum distance between the landscaped area and any down slope critical area (title 19 of Kitsap County code), impervious surface, open or closed conveyance system inlet, lot line, access easement, or right-of-way shall per table 5-7.
  - c. Soil Type B: 15% of the lot shall be retained as native vegetation. This vegetation shall be down slope of any landscaped areas to the maximum extent possible. The minimum distance between the landscaped area and any

## Appendix 5A: Rural Residential Major Developments

down slope critical area, impervious surface, open or closed conveyance system inlet, lot line, access easement, or right-of-way shall per table 5-7.

- d. **Soil Type C:** 22.5% of the lot shall be retained as native vegetation. This vegetation shall be down slope of any landscaped areas to the maximum extent possible. The minimum distance between the landscaped area and any down slope critical area, impervious surface, open or closed conveyance system inlet, lot line, access easement, or right-of-way shall per table 5-7.
  - e. **Soil Type D:** 50% of the lot shall be retained as native vegetation. This vegetation shall be down slope of any landscaped areas to the maximum extent possible. The minimum distance between the landscaped area and any down slope critical area, impervious surface, open or closed conveyance system inlet, lot line, access easement, or right-of-way shall per table 5-7.
- 4) The amount of impervious surface on the lot after project completion shall be less than 10% of the lot.
  - 5) Any converted impervious surfaces must be uncompacted and revegetated as follows:
    - a. Remove impervious layer (asphalt, Portland cement, etc.)
    - b. Scarify ground to a depth of 3 ft.
    - c. Incorporate composted soil amendments to a depth of 12" at the application rate designated in Table 5-6.
    - d. Revegetate

### 5A.0.2 Path C:

Native Vegetation Retention with Dispersion per the criteria listed below

- 1) Stormwater runoff from all impervious surfaces shall be routed to an infiltration system that conforms to the pre-engineered systems listed in tables 5-8 through 5-18 or a dispersion system designed per section 5A.2.0.
- 2) Retain or replant at least 65% of the lot in native vegetation. This vegetation shall be down slope of any landscaped areas to the maximum extent possible. The minimum distance between the landscaped area and any down slope critical area, impervious surface, open or closed conveyance system inlet, lot line, access easement, or right-of-way shall be per table 5-7.
- 3) The native vegetation retention areas shall be shown on a site plan that will be recorded along with a covenant restricting removal of the vegetation.
- 4) The amount of impervious surface on the lot after project completion shall be less than 5% of the lot.

## Appendix 5A: Rural Residential Major Developments

- 6) Any converted impervious surfaces must be uncompacted and revegetated as follows:
- a. Remove impervious layer (asphalt, Portland cement, etc.)
  - b. Scarify ground to a depth of 3 ft.
  - c. Incorporate composted soil amendments to a depth of 12" at the application rate designated in Table 5-6.
  - d. Revegetate

### 5A.1.0 Soil Amendments:

Soil amendments shall comply with Washington State Department of Transportation standard specification for compost {9-14.4(8)}. This specification is listed in BMP 3B-22 (Compost Berm)

Compost shall be tilled to a depth of 12 inches. Application rates shall be per table 5-6.

Soil Type	Cubic Yards of Compost per Acre of Landscaping
Type "A"	270 (equivalent to 2")
Type "B"	400 (equivalent to 3")
Type "C" or "D"	540 (equivalent to 4")

Table 5-6 Soil Amendment Application Rates

### 5A 2.0 Dispersion Criteria:

#### 5A.2.1 Sheet Flow Dispersion:

##### Applications:

Flat or moderately sloping (<15% slope) impervious surfaces such as driveways, sport courts, patios, and roofs without gutters; sloping cleared areas that are comprised of bare soil, non-native landscaping, lawns, and/or pasture; any situation where concentration of flows can be avoided.

##### Design Criteria:

See Figure 5-29 for driveways

A 2-foot wide transition zone to discourage channeling should be provided between the edge of the driveway pavement and the downslope vegetation, or under building eaves. This may be an extension of subgrade material (crushed rock), modular pavement, or drain rock.

A native vegetation dispersion area width per table 5-7 shall be provided for road widths to 20 feet. A proportional increase shall be applied for any widths greater than 20 feet. (Example: 30 ft wide road requires 50% more vegetative width)

Runoff cannot be directed toward a critical slope area (>30% slope) without a recommendation by a geotechnical engineer.

## Appendix 5A: Rural Residential Major Developments

### 5A.2.1 Dispersion Trenches:

#### Applications:

Roof downspouts, steep driveways (15% slope or greater), or any situation where flows are concentrated prior to dispersal.

#### Design Criteria:

See Figure 5-28 for details for dispersion trenches

A native vegetation dispersion area flow length per table 5-7 shall be provided for roof downspouts and road widths to 20 feet. A proportional increase shall be applied for any road widths greater than 20 feet. (Example: 30 ft wide road requires 50% more vegetative width)

Each trench can serve up to 700 square feet of impervious surface area. For larger impervious surfaces, Figure 5-29 includes details for a flow dispersal trench that can be installed on small sites at a ratio of 10 feet of trench per 700 square feet of impervious surface area.

The average slope of the dispersion area shall be 15% or less. If it exceeds 5% then the path length shall be increased as show in table 5-7 to maintain constant Tc.

Soil Type	Minimum Length of Native Vegetation Dispersion
Type "A"	50 ft (Add 10 ft for each % above 5% slope)
Type "B"	75 ft (Add 15 ft for each % above 5% slope)
Type "C" or "D"	100 ft (Add 20 ft for each % above 5% slope)

Table 5-7 Native Dispersion Flow Lengths

### 5A.3.0 Pre-Engineered Systems:

#### 5A.3.1 Infiltration Trenches

#### Design Criteria:

1. Facilities utilizing infiltration shall have bottoms a minimum of 18-inches above seasonal high ground water.
2. All retention facilities shall be a minimum of 200-feet from any slope steeper than 30%. This distance may be reduced based on a geotechnical engineering report.
3. All stormwater from surface other than rooftops, prior to discharge to a facility designed to utilize infiltration, shall pass through a designed biofiltration swale system and through

## Appendix 5A: Rural Residential Major Developments

a presettling device. In addition, all stormwater from paved areas subject to motor vehicle traffic shall flow through a spill-containment type oil/water separator.

4. For runoff quantity control facilities utilizing infiltration, those facilities shall be designed for a 100-year, 7-day storm event and also for a 100-year, 24-hour storm event, and shall have a maximum draw down time of 48-hours.
5. Until all project improvements which produce surface runoff are completed and all exposed ground surfaces are stabilized by revegetation or landscaping, facilities utilizing infiltration may not be operated, and no surface runoff may be permitted to enter the system.

### Sizing:

Tables 5-8 through 5-18 provide the maximum 100-yr 24-hr storm isopluvial that each size of infiltration device will accommodate. These tables cannot be interpolated.

### How to read the tables:

### Devices:

3-foot wide 1.5-foot deep infiltration trench designed per figure 5-25 for roofs or 5-23 for roads/driveways.

3-foot wide 3-foot deep infiltration trench designed per figure 5-25 for roofs or 5-23 for roads/driveways.

A gravelless infiltration chamber trench designed per figure 5-27. The Void space per linear foot shall be at least 2.6 cubic feet. The infiltrative surface per linear foot shall be at least 2.8 sq ft.

The following products are known to meet these gravelless chamber criteria

Infiltrator© High Capacity by Infiltrator Systems, Inc.

EnviroChamber© High Capacity by Hancor, Inc.

Stormtech© SC-310 by Infiltrator Systems, Inc.

For any other proprietary system, the applicant must provide manufacturer's specifications that show the product meets these gravelless chamber criteria.

### Soil Types:

Sand, Loamy Sand, Sandy Loam as determined per section 5.3.5.

### Rain levels:

## Appendix 5A: Rural Residential Major Developments

Each size of a device is listed with the maximum 100-yr 24-hr storm level that it can accommodate for a given amount of impervious surface. A shaded box indicates a length that will not accommodate the minimum 100-yr 24-hr storm for Kitsap County (2.5 inches) or exceeds the maximum 100-yr 24-hr storm for Kitsap County (9.0 inches).

### Examples:

**Example 1:** A 12.5-foot long 1.5 ft deep trench in sand will accommodate up to the 4.5-inch 100-yr 24-hr storm for up to 500 sq ft of impervious surface. An 18.75-foot long 1.5 ft deep trench in sand will accommodate up to the 7.0-inch 100-yr 24-hr storm for up to 500 sq ft of impervious surface. Therefore for a 500 sq ft impervious surface that receives 5.4 inches of rain for the 100-yr- 24-hr storm an 18.75-foot 1.5 ft deep trench in sand should be used.

**Example 2:** A project has 4400 sq ft of impervious surface to drain to a single infiltration trench located in loamy sand. It receives 4.8 inches of rain for the 100-yr 24-hr storm. The site can use any of the following:

- 175 ft of 3.0 ft deep trench
- 200ft of Gravelless Chamber trench

### 5A.3.2 Water Quality Systems:

All impervious surfaces that are subject to vehicular traffic and drain to an infiltration system shall drain through a biofiltration swale sized per Tables 5-19 through 5-29.

Impervious surfaces that use native vegetation dispersion per section 5A 2.0 do not require separate water quality treatment. These systems meet the filter strip design criteria of section 6.3.2.

**Pre-Engineered Infiltration Trenches for Fixed Impervious Surface Areas**

Length (Ft)	Sand	Loamy Sand	Sandy Loam
<b>1.5 ft deep</b>			
	<b>Max 100-yr storm</b>	<b>Max 100-yr storm</b>	<b>Max 100-yr storm</b>
12.5	4.5	2.5	
18.75	7	4	2.5
25	9	5.5	3.5
37.5		8	5
50		9	7
75			9
100			
<b>3.0 ft deep</b>			
	<b>Max 100-yr storm</b>	<b>Max 100-yr storm</b>	<b>Max 100-yr storm</b>
12.5	6.5	3.5	2.5
18.75	9	5.5	3.5
25		7	5
37.5		9	7.5
50			9
75			
100			
<b>Gravelless Chamber</b>			
	<b>Max 100-yr storm</b>	<b>Max 100-yr storm</b>	<b>Max 100-yr storm</b>
12.5	6	3.5	2.5
18.75	9	5	3.5
25		7	4.5
37.5		9	7
50			9
75			
100			

**Table 5-8: Infiltration Trenches for up to 500 sq ft of impervious surface**

**Pre-Engineered Infiltration Trenches for Fixed Impervious Surface Areas**

Length (Ft)	Sand	Loamy Sand	Sandy Loam
	Max 100-yr storm	Max 100-yr storm	Max 100-yr storm
<b>1.5 ft deep</b>			
12.5	2.5		
18.75	3.5		
25	5	2.5	
37.5	7	4	2.5
50	9	5	3.5
75		9	5.5
100			7
125			9
150			
<b>3.0 ft deep</b>			
	Max 100-yr storm	Max 100-yr storm	Max 100-yr storm
12.5	3		
18.75	5	2.5	
25	6.5	3.5	2.5
37.5	9	5.5	3.5
50		7	5
75		9	7.5
100			9
125			
150			
<b>Gravelless Chamber</b>			
	Max 100-yr storm	Max 100-yr storm	Max 100-yr storm
12.5	3		
18.75	4.5	2.5	
25	6	3.5	
37.5	8	5	3.5
50	9	7	4.5
75		9	7
100			9
125			

**Table 5-9: Infiltration Trench for up to 1000 sq ft of impervious surface**



**Pre-Engineered Infiltration Trenches for Fixed Impervious Surface Areas**

1.5 ft deep	Length (Ft)	Sand	Loamy Sand	Sandy Loam
		Max 100-yr storm	Max 100-yr storm	Max 100-yr storm
	37.5	3.5		
	50	5	2.5	
	75	7.5	4	2.5
	100	9	5	3.5
	125		6.5	4.5
	150		8	5.5
	175		9	6.5
	200			7
3.0 ft deep		Max 100-yr storm	Max 100-yr storm	Max 100-yr storm
	25	2.5		
	37.5	5	2.5	
	50	6.5	3.5	2.5
	75	9	5.5	3.5
	100		7	5
	125		9	6
	150			7.5
	175			8.5
	200			9
Gravelless Chamber		Max 100-yr storm	Max 100-yr storm	Max 100-yr storm
	18.75	2.5		
	25	3		
	37.5	4.5	2.5	
	50	6	3.5	2.5
	75	9	5	3.5
	100		6.5	4.5
	125		7	5.5
	150		8.5	7
	175		9	8
	200			9

**Table 5-10: Infiltration Trench for up to 2000 sq ft of impervious surface**

**Pre-Engineered Infiltration Trenches for Fixed Impervious Surface Areas**

1.5 ft deep	Length (Ft)	Sand	Loamy Sand	Sandy Loam
		Max 100-yr storm	Max 100-yr storm	Max 100-yr storm
	50	3		
	75	5	2.5	
	100	6.5	3.5	2.5
	125	8.5	4.5	3
	150	9	5.5	3.5
	175		6	4
	200		7	5
3.0 ft deep		Max 100-yr storm	Max 100-yr storm	Max 100-yr storm
	37.5			
	50	4.5	2.5	
	75	6.5	3.5	2.5
	100	9	4.5	3
	125		6	4
	150		7	5
	175		8.5	5.5
	200		9	6.5
Gravelless Chamber		Max 100-yr storm	Max 100-yr storm	Max 100-yr storm
	37.5	3		
	50	6		
	75	9	3.5	2.5
	100		4.5	3
	125		5.5	4
	150		6.5	4.5
	175		8	5.5
	200		9	6

**Table 5-11: Infiltration Trenches for up to 3000 sq ft of impervious surface**

**Pre-Engineered Infiltration Trenches for Fixed Impervious Surface Areas**

Length (Ft)	Sand	Loamy Sand	Sandy Loam
	Max 100-yr storm	Max 100-yr storm	Max 100-yr storm
<b>1.5 ft deep</b>			
50	2.5		
75	3.5		
100	5	2.5	
125	6	3.5	
150	7.5	4	2.5
175	9	4.5	3
200		5	3.5
<b>3.0 ft deep</b>			
	Max 100-yr storm	Max 100-yr storm	Max 100-yr storm
37.5			
50	3		
75	5	2.5	
100	6.5	3.5	2.5
125	8	4.5	3
150	9	5.5	3.5
175		6	4
200		7	5
<b>Gravelless Chamber</b>			
	Max 100-yr storm	Max 100-yr storm	Max 100-yr storm
37.5	2.5		
50	3		
75	4.5	2.5	
100	6.5	3.5	
125	8	4	3
150	9	5	3.5
175		6	4
200		7	4.5

**Table 5-12: Infiltration Trenches for up to 4000 sq ft of impervious surface**

**Pre-Engineered Infiltration Trenches for Fixed Impervious Surface Areas**

1.5 ft deep	Length (Ft)	Sand	Loamy Sand	Sandy Loam
		Max 100-yr storm	Max 100-yr storm	Max 100-yr storm
	50			
	75	3		
	100	4		
	125	5	2.5	
	150	6	3	
	175	7	3.5	2.5
	200	8	4	3
3.0 ft deep		Max 100-yr storm	Max 100-yr storm	Max 100-yr storm
	50	2.5		
	75	4		
	100	5	3	
	125	6.5	3.5	2.5
	150	8	4	3
	175	9	5	3.5
	200		5.5	4
Gravelless Chamber		Max 100-yr storm	Max 100-yr storm	Max 100-yr storm
	50	2.5		
	75	3.5		
	100	5	2.5	
	125	6	3.5	
	150	7.5	4	2.5
	175	9	4.5	3
	200		5.5	3.5

**Table 5-13: Infiltration Trenches for up to 5000 sq ft of impervious surface**

**Pre-Engineered Infiltration Trenches for Fixed Impervious Surface Areas**

1.5 ft deep	Length (Ft)	Sand	Loamy Sand	Sandy Loam
		Max 100-yr storm	Max 100-yr storm	Max 100-yr storm
	50			
	75	2.5		
	100	3		
	125	4		
	150	5	2.5	
	175	5.5	3	
	200	6.5	3.5	2.5
3.0 ft deep		Max 100-yr storm	Max 100-yr storm	Max 100-yr storm
	50			
	75	3		
	100	4.5	2.5	
	125	5.5	3	
	150	6.5	3.5	2.5
	175	7.5	4	3
	200	9	4.5	3
Gravelless Chamber		Max 100-yr storm	Max 100-yr storm	Max 100-yr storm
	50			
	75	3		
	100	4		
	125	5	3	
	150	6.5	3.5	2.5
	175	7.5	4	2.5
	200	8.5	4.5	3

**Table 5-14: Infiltration Trenches for up to 6000 sq ft of impervious surface**

**Pre-Engineered Infiltration Trenches for Fixed Impervious Surface Areas**

1.5 ft deep	Length (Ft)	Sand	Loamy Sand	Sandy Loam
		Max 100-yr storm	Max 100-yr storm	Max 100-yr storm
	50			
	75			
	100	2.5		
	125	3.5		
	150	4		
	175	4.5	2.5	
	200	5.5	3	
3.0 ft deep		Max 100-yr storm	Max 100-yr storm	Max 100-yr storm
	50	2.5		
	75	3		
	100	3.5		
	125	4.5	2.5	
	150	5.5	3	
	175	6.5	3.5	2.5
	200	7.5	4	
Gravelless Chamber		Max 100-yr storm	Max 100-yr storm	Max 100-yr storm
	50			
	75	2.5		
	100	3.5		
	125	4.5	2.5	
	150	5.5	3	
	175	6.5	3.5	
	200	7	4	2.5

**Table 5-15: Infiltration Trenches for up to 7000 sq ft of impervious surface**

**Pre-Engineered Infiltration Trenches for Fixed Impervious Surface Areas**

1.5 ft deep	Length (Ft)	Sand	Loamy Sand	Sandy Loam
		Max 100-yr storm	Max 100-yr storm	Max 100-yr storm
	50			
	75			
	100	2.5		
	125	3		
	150	3.5		
	175	4.5		
	200	5	2.5	
3.0 ft deep		Max 100-yr storm	Max 100-yr storm	Max 100-yr storm
	50			
	75	2.5		
	100	3		
	125	4		
	150	5	2.5	
	175	6	3	
	200	6.5	3.5	2.5
	Gravelless Chamber		Max 100-yr storm	Max 100-yr storm
50				
75		2.5		
100		3		
125		4		
150		4.5	2.5	
175		5.5	3	
200		6.5	3.5	

**Table 5-16: Infiltration Trenches for up to 8000 sq ft of impervious surface**

**Pre-Engineered Infiltration Trenches for Fixed Impervious Surface Areas**

1.5 ft deep	Length (Ft)	Sand	Loamy Sand	Sandy Loam
		Max 100-yr storm	Max 100-yr storm	Max 100-yr storm
	50			
	75			
	100			
	125	2.5		
	150	3.5		
	175	4		
	200	4.5	2.5	
3.0 ft deep		Max 100-yr storm	Max 100-yr storm	Max 100-yr storm
	50			
	75			
	100	3		
	125	3.5		
	150	4.5	2.5	
	175	5		
	200	6	3	
Gravelless Chamber		Max 100-yr storm	Max 100-yr storm	Max 100-yr storm
	50			
	75			
	100	2.5		
	125	3.5		
	150	4	2.5	
	175	5	3	
	200	5.5	3.5	

**Table 5-17: Infiltration Trenches for up to 9000 sq ft of impervious surface**



**Pre-Engineered Infiltration Trenches for Fixed Impervious Surface Areas**

Length (Ft)	Sand	Loamy Sand	Sandy Loam
	Max 100-yr storm	Max 100-yr storm	Max 100-yr storm
<b>1.5 ft deep</b>			
50			
75			
100			
125	2.5		
150	3		
175	3.5		
200	4		
<b>3.0 ft deep</b>			
50			
75			
100	2.5		
125	3		
150	4		
175	4.5	2.5	
200	5	3	
<b>Gravelless Chamber</b>			
50			
75			
100	2.5		
125	3.5		
150	4	2.5	
175	4.5	3	
200	5		

**Table 5-18: Infiltration Trenches for up to 10,000 sq ft of impervious surface**

**Pre-Engineered Biofiltration Swales**

2yr Storm (in)	1	1.5	2	2.5	3	3.5	4	4.5	5
<b>Base Width/Slope</b>									
<b>2 ft</b>									
1%	13	16	18	20	22	23	24	26	27
2%	16	20	23	25	27	29	30	32	33
3%	18	23	26	28	31	32	34	36	38
4%	20	25	28	31	34	36	38	39	41
5%	21	26	30	33	36	38	40	42	44
6%	23	28	32	35	38	40	43	45	47
<b>3 ft</b>									
1%	11	14	16	17	19	20	21	22	23
2%	14	17	20	22	23	25	26	28	29
3%	16	19	22	24	26	28	30	31	33
4%	17	21	24	27	29	31	32	34	36
5%	18	23	26	28	31	33	35	36	38
6%	19	24	27	30	33	35	37	39	40
<b>4 ft</b>									
1%	10	12	14	16	17	18	19	20	21
2%	12	15	17	19	21	22	24	25	26
3%	14	17	20	22	24	25	27	28	29
4%	15	19	22	24	26	27	29	31	32
5%	16	20	23	25	28	29	31	33	34
6%	17	21	24	27	29	31	33	35	36

**Table 5-19: Biofiltration Swales for up to 500 sq ft of impervious surface (Required Length in ft)**

**Pre-Engineered Biofiltration Swales**

2yr Storm (in)	1	1.5	2	2.5	3	3.5	4	4.5	5
<b>Base Width/Slope</b>									
<b>2 ft</b>									
1%	17	21	17	26	28	30	32	33	34
2%	21	26	21	32	35	37	39	41	43
3%	24	29	24	37	40	42	45	47	49
4%	26	32	26	40	43	46	49	51	53
5%	28	34	28	43	47	50	52	55	57
6%	30	36	30	46	49	53	55	58	61
<b>3 ft</b>									
1%	15	18	15	23	25	26	28	29	30
2%	18	22	18	28	30	32	34	36	37
3%	21	25	21	32	34	37	39	41	42
4%	22	28	22	35	38	40	42	45	46
5%	24	30	24	37	40	43	45	48	50
6%	25	31	25	39	43	46	48	50	53
<b>4 ft</b>									
1%	13	16	13	20	22	24	25	26	27
2%	16	20	16	25	27	29	31	32	34
3%	18	23	18	29	31	33	35	37	38
4%	20	25	20	31	34	36	38	40	42
5%	21	26	21	33	36	39	41	43	45
6%	23	28	23	35	38	41	43	45	47

**Table 5-20: Biofiltration Swales for up to 1000 sq ft of impervious surface (Required Length in ft)**

**Pre-Engineered Biofiltration Swales**

2yr Storm (in)	1	1.5	2	2.5	3	3.5	4	4.5	5
<b>Base Width/Slope</b>									
<b>2 ft</b>									
1%	22	27	31	34	36	38	40	42	44
2%	27	34	38	42	45	48	51	53	55
3%	31	38	43	48	51	55	58	60	63
4%	34	42	48	52	56	60	63	66	69
5%	36	45	51	56	60	64	68	71	74
6%	39	47	54	59	64	68	72	75	78
<b>3 ft</b>									
1%	19	24	27	30	32	34	36	38	39
2%	24	29	33	37	40	42	45	47	49
3%	27	33	38	42	45	48	51	53	55
4%	29	36	41	46	49	52	55	58	60
5%	31	39	44	49	53	56	59	62	65
6%	33	41	47	52	56	59	63	66	69
<b>4 ft</b>									
1%	17	21	24	27	29	31	33	34	36
2%	21	26	30	33	36	38	40	42	44
3%	24	30	34	38	41	43	46	48	50
4%	26	32	37	41	44	47	50	52	55
5%	28	35	40	44	47	51	53	56	59
6%	30	37	42	46	50	54	57	59	62

**Table 5-21: Biofiltration Swales for up to 2000 sq ft of impervious surface (Required Length in ft)**

**Pre-Engineered Biofiltration Swales**

2yr Storm (in)	1	1.5	2	2.5	3	3.5	4	4.5	5
<b>Base Width/Slope</b>									
<b>2 ft</b>									
1%	26	31	36	39	42	44	47	48	102
2%	32	39	44	49	52	56	58	61	130
3%	36	44	51	55	60	63	67	70	151
4%	40	49	55	61	65	69	73	76	167
5%	43	52	59	65	70	75	78	82	180
6%	45	55	63	69	74	79	83	87	192
<b>3 ft</b>									
1%	22	28	31	34	37	40	42	44	97
2%	28	34	39	43	46	49	52	54	124
3%	32	39	44	49	53	56	59	62	142
4%	34	42	48	53	57	61	64	67	157
5%	37	45	52	57	62	65	69	72	169
6%	39	48	55	60	65	69	73	77	180
<b>4 ft</b>									
1%	20	25	28	31	34	36	38	40	93
2%	25	31	35	39	42	45	47	49	117
3%	28	35	40	44	48	51	53	56	134
4%	31	38	43	48	52	55	58	61	147
5%	33	41	47	51	56	59	63	66	159
6%	35	43	49	54	59	63	66	69	168

**Table 5-22: Biofiltration Swales for up to 3000 sq ft of impervious surface (Required Length in ft)**

## Pre-Engineered Biofiltration Swales

2yr Storm (in)	1	1.5	2	2.5	3	3.5	4	4.5	5
<b>Base Width/Slope</b>									
<b>2 ft</b>									
1%	29	35	39	43	46	49	51	53	55
2%	36	44	49	54	58	61	64	67	70
3%	41	50	56	62	66	70	74	77	80
4%	44	54	62	67	73	77	81	84	88
5%	47	58	66	72	78	83	87	91	94
6%	50	62	70	77	83	88	92	96	100
<b>3 ft</b>									
1%	26	31	35	38	41	44	46	48	50
2%	31	38	43	48	51	55	58	60	63
3%	35	43	49	54	58	62	66	69	71
4%	38	47	54	59	64	68	72	75	78
5%	42	51	58	64	69	73	77	81	84
6%	44	54	61	67	73	77	81	85	89
<b>4 ft</b>									
1%	23	28	32	35	38	40	42	44	46
2%	28	34	39	43	47	50	53	55	57
3%	32	39	45	49	53	56	60	62	65
4%	36	43	49	54	58	62	65	68	71
5%	37	46	52	57	62	66	70	73	76
6%	39	48	55	61	66	70	74	77	81

**Table 5-23: Biofiltration Swales for up to 4000 sq ft of impervious surface (Required Length in ft)**

## Pre-Engineered Biofiltration Swales

2yr Storm (in) Base Width/Slope	1	1.5	2	2.5	3	3.5	4	4.5	5
<b>2 ft</b>									
1%	31	38	43	47	50	53	55	57	59
2%	39	47	53	58	63	66	70	72	75
3%	44	54	61	67	71	76	79	83	86
4%	48	59	67	73	78	83	87	91	95
5%	52	63	72	78	84	89	94	98	102
6%	55	67	76	83	89	95	100	104	108
<b>3 ft</b>									
1%	27	33	38	42	45	48	50	52	54
2%	34	42	47	52	56	59	62	65	68
3%	38	47	54	59	63	68	71	74	77
4%	42	51	59	64	70	74	78	81	85
5%	45	55	63	69	75	79	84	87	91
6%	47	58	66	73	79	84	89	93	96
<b>4 ft</b>									
1%	25	30	35	38	41	44	46	48	50
2%	30	38	43	47	51	54	57	60	62
3%	35	43	48	53	58	61	65	68	71
4%	38	46	53	58	63	67	71	74	77
5%	40	50	57	63	68	72	76	80	83
6%	43	53	60	66	72	76	80	84	88

**Table 5-24: Biofiltration Swales for up to 5000 sq ft of impervious surface (Required Length in ft)**

## Pre-Engineered Biofiltration Swales

2yr Storm (in)	1	1.5	2	2.5	3	3.5	4	4.5	5
<b>Base Width/Slope</b>									
<b>2 ft</b>									
1%	33	40	45	49	53	56	59	61	63
2%	42	50	57	62	67	70	74	77	80
3%	47	57	65	71	76	81	85	88	91
4%	52	63	71	78	84	89	93	97	101
5%	55	68	77	84	90	95	100	104	108
6%	59	72	81	89	95	101	106	111	115
<b>3 ft</b>									
1%	29	36	41	44	48	51	53	56	58
2%	36	44	51	55	60	63	67	70	72
3%	41	50	57	63	68	72	76	79	83
4%	45	55	63	69	74	79	83	87	91
5%	48	59	67	74	80	85	89	93	97
6%	51	63	71	78	84	90	95	99	103
<b>4 ft</b>									
1%	26	32	37	41	44	47	49	51	53
2%	33	40	46	51	54	58	61	64	67
3%	37	46	52	57	62	66	69	73	76
4%	40	50	57	63	68	72	76	80	83
5%	43	53	61	67	72	77	81	85	89
6%	46	56	64	71	77	82	86	90	94

**Table 5-25: Biofiltration Swales for up to 6000 sq ft of impervious surface (Required Length in ft)**



## Pre-Engineered Biofiltration Swales

2yr Storm (in)	1	1.5	2	2.5	3	3.5	4	4.5	5
<b>Base Width/Slope</b>									
<b>2 ft</b>									
1%	35	43	48	52	56	59	61	64	66
2%	44	53	60	66	70	74	78	81	84
3%	50	61	69	75	80	85	89	93	96
4%	55	67	75	82	88	93	98	102	106
5%	59	72	81	88	95	100	105	110	114
6%	62	76	86	94	101	107	112	117	121
<b>3 ft</b>									
1%	31	38	43	47	50	54	56	59	61
2%	39	47	53	59	63	67	70	74	76
3%	44	53	61	67	72	76	80	84	87
4%	48	59	67	73	79	84	88	92	96
5%	51	63	71	78	84	90	95	99	103
6%	54	66	76	83	89	95	100	105	109
<b>4 ft</b>									
1%	28	34	39	43	46	49	52	54	56
2%	35	43	49	54	58	61	65	68	70
3%	39	48	55	61	66	70	74	77	80
4%	43	53	60	66	72	76	80	84	88
5%	46	57	65	71	77	82	86	90	94
6%	49	60	68	75	81	87	91	96	100

**Table 5-26: Biofiltration Swales for up to 7000 sq ft of impervious surface (Required Length in ft)**

## Pre-Engineered Biofiltration Swales

2yr Storm (in)	1	1.5	2	2.5	3	3.5	4	4.5	5
<b>Base Width/Slope</b>									
<b>2 ft</b>									
1%	37	45	50	54	58	61	64	67	69
2%	46	56	63	69	73	78	81	84	88
3%	52	64	72	78	84	89	93	97	100
4%	58	70	79	86	92	98	102	107	111
5%	62	75	85	93	99	105	110	115	119
6%	65	80	90	98	105	112	117	122	127
<b>3 ft</b>									
1%	33	40	45	49	53	56	59	61	64
2%	41	49	56	62	66	70	74	77	80
3%	46	56	64	70	75	80	84	88	91
4%	50	61	70	77	83	88	92	96	100
5%	54	66	75	82	89	94	99	104	108
6%	57	70	79	87	94	100	105	110	114
<b>4 ft</b>									
1%	30	36	41	45	49	52	54	57	59
2%	37	45	51	56	61	64	68	71	74
3%	41	51	58	64	69	73	77	81	84
4%	45	56	63	70	75	80	85	89	92
5%	48	60	68	75	81	86	91	95	99
6%	51	63	72	79	86	91	96	101	105

**Table 5-27: Biofiltration Swales for up to 8000 sq ft of impervious surface (Required Length in ft)**

**Pre-Engineered Biofiltration Swales**

2yr Storm (in)	1	1.5	2	2.5	3	3.5	4	4.5	5
<b>Base Width/Slope</b>									
<b>2 ft</b>									
1%	39	46	52	57	60	64	67	69	72
2%	48	58	66	71	76	81	84	88	91
3%	55	66	75	82	87	92	97	101	104
4%	60	73	82	90	96	102	107	111	115
5%	64	78	88	97	103	109	115	120	124
6%	68	83	94	102	110	116	122	127	132
<b>3 ft</b>									
1%	34	41	47	51	55	58	61	64	66
2%	42	52	59	64	69	73	77	80	83
3%	48	59	67	73	79	83	88	92	95
4%	53	64	73	80	86	92	96	101	105
5%	56	69	78	86	93	98	103	108	112
6%	60	73	83	91	98	104	110	115	119
<b>4 ft</b>									
1%	31	38	43	47	51	54	57	59	62
2%	38	47	53	59	63	67	71	74	77
3%	43	53	61	67	72	77	81	84	88
4%	47	58	66	73	79	84	88	92	96
5%	51	62	71	78	84	90	95	99	103
6%	54	66	75	83	89	95	100	105	109

**Table 5-28: Biofiltration Swales for up to 9000 sq ft of impervious surface (Required Length in ft)**

**Pre-Engineered Biofiltration Swales**

2yr Storm (in)	1	1.5	2	2.5	3	3.5	4	4.5	5
<b>Base Width/Slope</b>									
<b>2 ft</b>									
1%	40	48	54	59	62	66	69	71	74
2%	50	60	68	74	79	83	87	91	94
3%	57	69	78	85	90	96	100	104	108
4%	62	76	85	93	100	105	110	115	119
5%	67	81	92	100	107	113	119	124	128
6%	71	86	97	106	114	120	126	132	136
<b>3 ft</b>									
1%	35	43	49	53	57	61	64	66	69
2%	44	54	61	67	72	76	80	83	86
3%	50	61	69	76	82	87	91	95	99
4%	55	67	76	83	90	95	100	104	108
5%	59	72	81	89	96	102	107	112	117
6%	62	76	86	95	102	108	114	119	124
<b>4 ft</b>									
1%	32	39	45	49	53	56	59	62	64
2%	40	49	56	61	66	70	74	77	80
3%	45	55	63	69	75	80	84	88	91
4%	49	61	69	76	82	87	92	96	100
5%	53	65	74	81	88	93	99	103	107
6%	56	69	78	86	93	99	104	109	114

**Table 5-29: Biofiltration Swales for up to 10,000 sq ft of impervious surface (Required Length in ft)**

## **SFR-SDAP Site Plan Checklist**

1. Name, address and telephone of the applicant, agent, or owner.
2. Name, address, telephone, seal, and signature of the Engineer preparing the plan.
3. Parcel number(s) and brief legal description of property.
4. Scale with north arrow
  - a. 1"=30' minimum for parcels of less than one acre
  - b. 1"=40' minimum for parcels between 1 and 2½ acres.
  - c. For parcels that exceed 2½ acres, or for parcels of irregular shape, site plan overviews at scales of up to 1"=100' are permitted provided an inset plan of the structure(s), on-site sewage system and proposed drainage system are included at a 1"=30' or 1"=40' scale.
5. Legend, if symbols are used that are not labeled in the plan.
6. Vicinity map of sufficient clarity to locate the property. (show names of any abutting streets)
7. Existing and proposed structures and other impervious surfaces such as parking lots, driveways, patios, buildings, etc. Approaches to county right-of-way shall indicate surfacing material, throat width, return radii, and longitudinal slope. (A detail may be required)
8. Indicate the location of all existing septic components, including septic tanks, pump tanks, pre-treatment units, primary drainfields and reserve drainfields. Indicate the direction and degree of slopes of all primary and reserve drainfield areas, and identify the 10-foot "no-build" zones surrounding them.
9. Existing and/or proposed utilities, with easements identified.
10. Established or proposed buffers, significant trees, and natural vegetation easements or covenant areas, if any.
11. Natural drainage channels, wetlands, water bodies, etc. Include direction of flow.
12. Proposed clearing limits.
13. Indicate the locations and grades for all slopes greater than 15%, as well as all cut banks that exceed 4' in height
14. Areas to be graded, filled, excavated, or otherwise disturbed. The location of graded slopes shall be indicated, together with the proposed steepness and height. The location of stockpiles, haul roads and disposal sites shall also be indicated.
15. The location of on-site and adjacent off-site (within 100 ft of project boundaries) wells, underground storage tanks, etc. If none, state so on plan or separate letter.
16. The location and type of erosion and sedimentation control measures proposed including details of each used.
17. If infiltration used, show location of any soil test pits
18. Driveway cross section with any associated ditches
19. Topography Requirements:
  - a. Elevations of any existing or proposed man-made conveyance systems (catch basins,

## SFR-SDAP Site Plan Checklist

pipe inverts, etc.)

- b. Finish floor elevations for all proposed buildings.
- c. Flow arrows or spot elevations that clearly indicate how driveways and any parking areas are to be graded.
- d. Contour lines from the best available source, spot elevations, or indications of direction and steepness of slopes, with the source clearly identified.
- e. Property boundaries and dimensions
- f. Location of at least 1 temporary benchmark shall be shown
- g. Datum shall be per section 7.2.4 of the stormwater design manual if creating a drainage system located with County right-of-way or connecting into such a system. Otherwise an assumed datum with reference point of plumbing stub-out or first floor level.

### 20. Required Details

- a. Erosion Control BMP's
- b. Approach to County Right-of-way
- c. Ditch or bioswale cross-section
- d. Infiltration or Detention system cross-section(s) showing 100 yr 24 hr storm elevation
- e. Overflow or flow restriction devices

### 21. Maintenance Manual:

Customize the standard maintenance manual found in Appendix 8B of the stormwater design manual.

- a. Add 11" x 17" drawing of the site labeling any maintenance items with the following symbols (Include a legend on the drawing):
  - CB: Catch Basin
  - CS: Control Structure
  - PB: Pre-Settling Basin
  - IT: Infiltration Trench
  - DT: Dispersion Trench
  - Bio: Biofiltration Swale
  - NC: Native Vegetation Covenant Area
  - IP: Infiltration Pond
  - DP: Detention Pond
- b. If detention is used provide a detail of the flow restrictor showing all orifice or notch sizes and elevations
- c. If any other maintenance items exist that are not included in the Appendix 8B manual, the project engineer shall include maintenance directions for such items. These directions can be proprietary system maintenance manuals.

## SFR-SDAP Drainage Report Checklist

The Drainage Report shall be on 8-1/2" x 11" paper and maps shall be folded to 8-1/2" x 11" size. The Drainage Report shall be prepared by and bear the stamp of a professional engineer licensed in the State of Washington and shall contain the following information:

1. Cover Sheet, including the project name, proponent's name, address and telephone number, Project Engineer, and date of submittal.
2. Project Description:
  - a. Describe the size and location of the project site, address and parcel number.
  - b. Describe other permits required (e.g. Hydraulic Project Approval, Corps of Engineers 404 Fill Permit, etc.).
  - c. Describe the project, including proposed site improvements, proposed construction of impervious surfaces, proposed landscaping, etc.
3. Existing Conditions: Describe existing site conditions and relevant hydrological conditions including but not limited to:
  - a. Project site topography
  - b. Land cover of parcel and abutting property;
  - c. Off site drainage to the property; creeks, lakes, ponds, wetlands, ravines, gullies, steep slopes, springs and other environmentally sensitive areas on or adjacent to the project site;
  - d. Location of any wells both "of record" and others on the project site and on adjacent property within 100' of the project boundaries;
  - e. General soils conditions present within the project site;
  - f. Existing natural and manmade drainage facilities within and immediately adjacent to the project site;
  - g. Points of discharge for existing drainage from the project site. Include references to relevant reports such as basin plans, flood studies, groundwater studies, wetland designation, sensitive area designation, environmental impact statements, lake restoration plans, water quality reports, etc. Where such reports impose additional conditions on the Proponent, those conditions shall be included in the report.
4. Developed Site Drainage Conditions:
  - a. Describe the land cover resulting from the proposed project;
  - b. Describe the potential stormwater quantity and quality impacts resulting from the proposed project;
  - c. Describe the proposal for the collection and conveyance of site runoff from the project site, for the control of any increase in stormwater quantity resulting from the project, and for the control of stormwater quality.
5. Drainage Basin Description: Describe the drainage basin(s) to which the project site contributes runoff, and identify the receiving waters for each of these drainage basins.
6. Description of upstream basins, identifying any sources of runoff to the project site. This should be based on a field investigation. Any existing drainage or erosion problems upstream, which may have an impact on the proposed development, should be noted. If no upstream basin contribution, note so in report.
7. Downstream Analysis: The initial drainage report submittal must include a Level I Downstream Drainage Analysis, for review by the County for sites that propose either detention or dispersion designs. Sites proposing 100% infiltration shall only submit a downstream analysis if requested by the County or if the site lies within an identified critical drainage area. Any further analysis of downstream conditions required beyond the Level 1 analysis shall become a part of the drainage report and must be submitted as part of the Drainage Report.

## SFR-SDAP Drainage Report Checklist

8. Soils Report(s) & Geotechnical Report(s) where applicable, prepared by a qualified professional engineer.
9. Basin Map(s), showing
  - a. Boundaries of project,
  - b. Any offsite contributing drainage basins,
  - c. Onsite drainage basins,
  - d. Approximate locations of all major drainage structures within the basins,
  - e. Depict the course of stormwater originating from the subject property and extending all the way to Puget Sound or to the closest receiving body of water (lakes, creeks, etc.).
  - f. Reference the source of the topographic base map (e.g. USGS), the scale of the map, and include a north arrow.
10. Hydraulic Design Computations: (Not required for pre engineered systems contained in this manual)

Supporting the design of ALL proposed stormwater conveyance, quantity and quality control facilities, and verifying the capacity of existing and proposed drainage facilities. These computations may include capacity and backwater analysis required either as part of the proposed drainage design or as a part of the downstream drainage investigation, and flood routing computations required for the design of detention/retention storage facilities, for wetland impact analysis, or for flood plain analysis.
11. Erosion and Sedimentation Control Design Report and Computations, including the following:
  - a. Description of proposed erosion control objectives and strategies;
  - b. Description of erosion control facilities and other temporary water quality facilities proposed;
  - c. Description of the revegetation plan for the project site;
  - d. Identification of areas of concern regarding soil stability and/or water quality impacts;
  - e. Computations for the sizing of temporary stormwater conveyance and quantity control facilities;
  - f. Computations for the design and sizing of proposed sediment containment facilities, etc.
12. Appendices: Include the following:

Copies of any additional relevant reports, prepared by others, which support or corroborate the findings, conclusions, or assumptions contained in the drainage report; copies of any additional permits (or completed permit applications) required for the project.



## **SFR-SDAP Required Plan Notes**

**As a minimum the following notes shall be affixed to each Site Development Activity Permit (SDAP) plan set submitted for a Single Family Residence.**

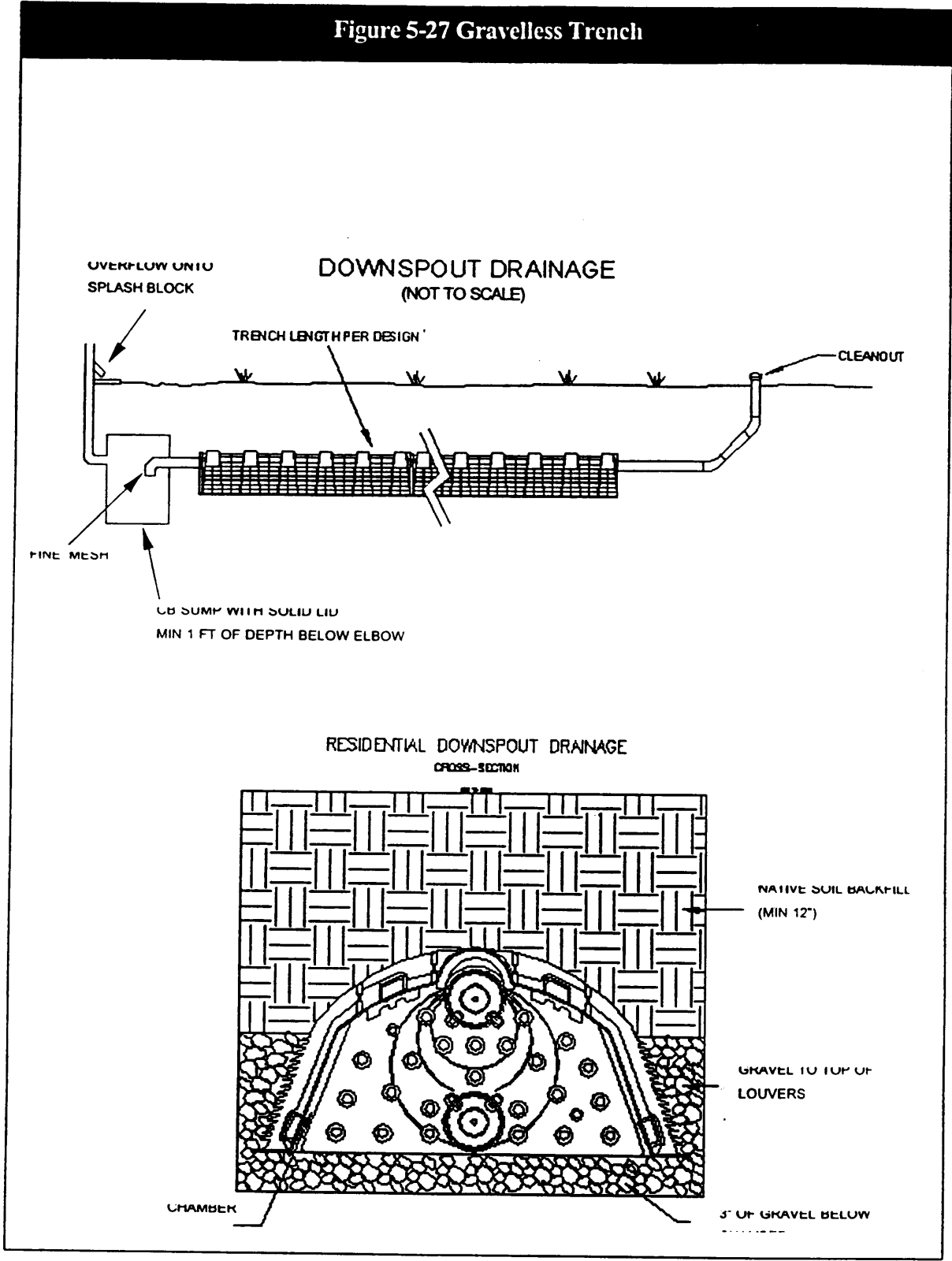
**If the SDAP includes greater than 150 cubic yards of grading, all the notes contained in Appendix 2A shall be affixed to the plan set.**

1. **The Owner and his/her Contractor shall be responsible at all times for preventing silt laden runoff from discharging from the project site. Failure by the Owner and/or Contractor may result in a fine. The designated emergency contact person noted on this Plan shall be available by telephone on a 24-hour basis throughout construction until the project is complete and approved by Kitsap County.**

Name: \_\_\_\_\_ Phone: \_\_\_\_\_

2. **The implementation of this Erosion and Sedimentation Control (ESC) Plan and the construction, maintenance, replacement and upgrading of these ESC facilities is the responsibility of the Owner and/or Contractor from the beginning of construction until all construction is complete and accepted by Kitsap County and the site is permanently stabilized.**
3. **The Owner and/or Contractor shall inspect all Erosion and Sedimentation Control (ESC) facilities on a frequent basis and immediately after each rainfall. The ESC facilities shall be maintained as necessary to insure their continued effectiveness. All sediment must be removed from silt fences, straw bales, sediment ponds, etc. prior to the sediment reaching one half of the maximum potential depth.**
4. **The Contractor shall maintain a set of the accepted construction drawings on site at all times during construction. These drawings shall be used by the Contractor to document as built conditions and shall be provided to the Project Engineer following project completion.**
5. **Any revisions to the accepted construction plans shall be reviewed and approved by Kitsap County prior to implementation in the field.**
6. **The Contractor shall notify the Project Engineer upon discovery of poor soils, groundwater, unanticipated conditions, or discrepancies in the existing conditions as noted on the plans.**
7. **All grading shall conform to Chapter 4 of the Kitsap County Stormwater Design Manual with emphasis on the following requirements:**
  - a. **Grading shall take place in such a manner so as not to obstruct or otherwise interfere with the natural drainage flows through the site;**
  - b. **The area receiving fill material shall be prepared by removing vegetation, non-complying fill, topsoil, and other unsuitable material and scarify the surface to provide a bond with the new fill.**
  - c. **Fill materials shall not contain organic material such as wood or sod, and rock or other similar irreducible material with a maximum dimension greater than 12 inches;**
  - d. **The fill material shall be placed in relatively thin horizontal layers and be compacted to at least 90% of maximum dry density (95% for driveways and berms); and**
  - e. **Slopes shall be no steeper than 2 horizontal to 1 vertical (2:1)**

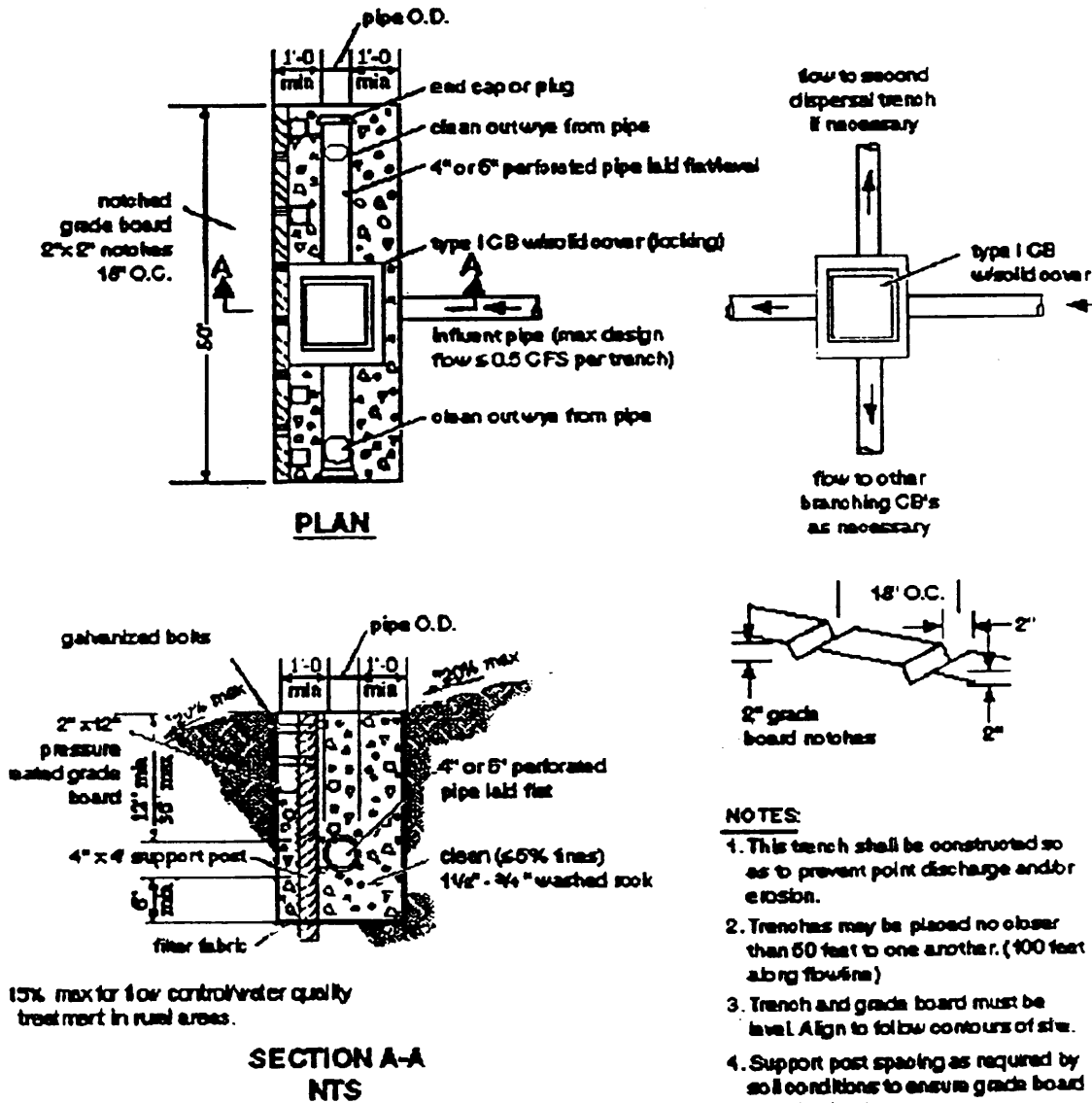
Figure 5-27 Gravelless Trench



Courtesy Infiltrator Inc.

Figure 5-28 Flow Dispersion Trench (Large)

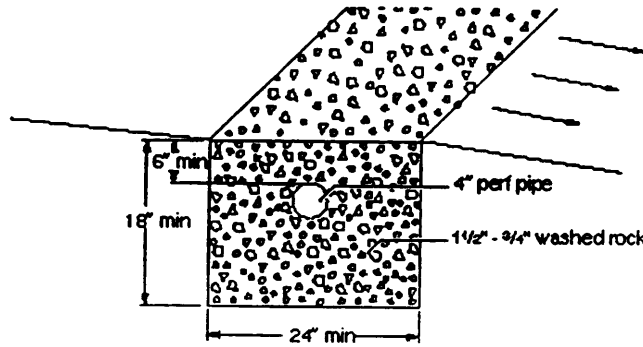
For >700 sq ft of impervious surface. If < 700 sq ft of impervious surface is being dispersed, see figure 5-29.



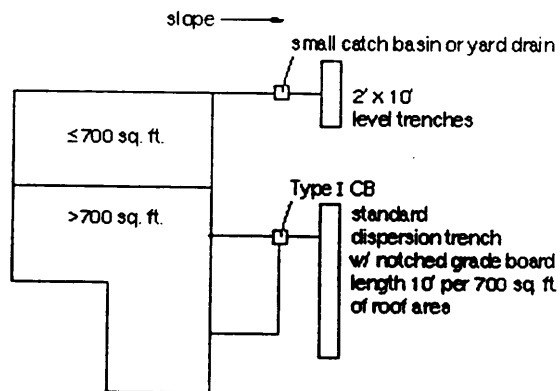
Flow Dispersion Trench

**Figure 5-29 Flow Dispersion Trench (Small)**

For <700 sq ft of impervious surface. If > 700 sq ft of impervious surface is dispersed, see figure 5-28.

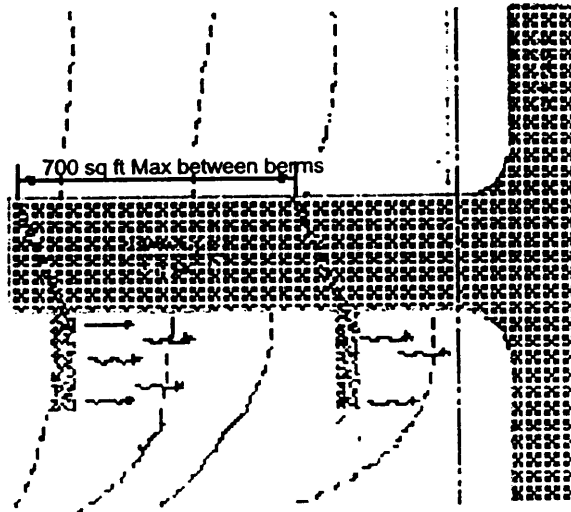
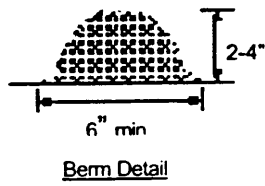


**TRENCH X-SECTION**  
NTS

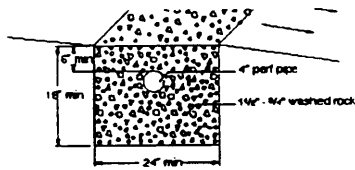


**Roof Plan View**  
NTS

Figure 5-30 Driveway Flow Dispersion

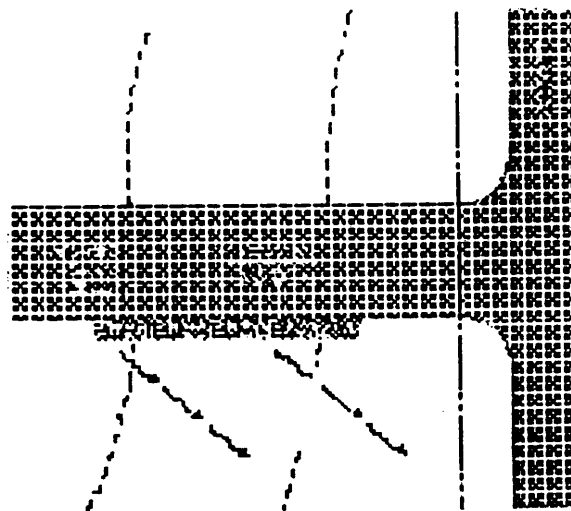


Steep Slope Driveway



TRENCH X-SECTION  
NTS

Trench sized per section 5A.2.1



Moderate Slope Driveway



## CHAPTER 6

# STORMWATER QUALITY CONTROL FACILITIES





# **CHAPTER 6**

## **STORMWATER QUALITY CONTROL FACILITIES**

### **CONTENTS**

<b>6.1</b>	<b>KNOWN POLLUTANTS IN STORMWATER</b>	<b>6-1</b>
<b>6.2</b>	<b>WATER QUALITY DESIGN STORM</b>	<b>6-3</b>
<b>6.3</b>	<b>BIOFILTRATION BMPs</b>	<b>6-3</b>
	6.3.1 SWALE DESIGN CRITERIA	6-3
	6.3.2 FILTER STRIP DESIGN CRITERIA	6-5
<b>6.4</b>	<b>WET PONDS AND WET VAULTS/TANKS</b>	<b>6-5</b>
	6.4.1 WET POND DESIGN	6-6
	SIZING WET PONDS	6-6
	POND CONFIGURATION AND GEOMETRY	6-6
	ACCESS	6-7
	SITE CONSTRAINTS	6-7
	DAM SAFETY	6-7
	6.4.2 WET VAULT AND WET TANK DESIGN	6-8
	LIMITATION	6-8
	PURPOSE AND DEFINITION	6-8
	SIZING CRITERIA	6-8
	GEOMETRICS	6-8
	MATERIALS AND STRUCTURAL STABILITY	6-8
	ACCESS	6-9
<b>6.5</b>	<b>OIL/WATER SEPARATORS</b>	<b>6-9</b>



# STORMWATER QUALITY CONTROL FACILITIES

Kitsap County requires that land development activities address the development's impact on stormwater quality as well as quantity.

This chapter describes permanent facilities which can significantly improve the removal of finer sediment and metals. One of these facilities, or other treatment BMP approved by the Director, will be required prior to stormwater discharges from all major development sites. Selection of appropriate stormwater treatment BMPs is dependent on site constraints, proposed land use and downstream conditions. The reader is encouraged to refer to the Department of Ecology's "Stormwater Management Manual for the Puget Sound Basin" for detailed information regarding BMP selection and design criteria. Permanent treatment BMPs described below are considered to meet the minimum requirements of the Stormwater Management Ordinance. Kitsap County encourages innovative approaches to providing stormwater treatment. Where site constraints dictate, consideration should be given to sand or compost filters, specialized water quality vaults, and a host of other emerging technologies. A wide range of product literature and design information is available for the designer's use.

This chapter provides detail for a spill control (SC) type oil/water separator which is required for all areas subject to vehicular traffic. Other types of oil/water separators may be required for development sites with certain industrial or commercial uses. Design information can be found for these other types of separators in the D.O.E. stormwater manual as well as from the product manufacturers.

## 6.1 KNOWN POLLUTANTS IN STORMWATER

Pollutants typically found in stormwater runoff in developing areas include the following:

- o Sediment
- o Metals (e.g. copper, lead, zinc)
- o Oil, grease and other petroleum hydrocarbon
- o Nutrients (e.g. phosphorus, nitrogen)
- o Fecal Coliform ( a non-pathogenic indicator of possible pathogenic bacteria)

**Sediment:** Policies contained elsewhere in this Manual address not only the source control of sediment pollution but also the treatment of sediment-laden runoff. The policies concerning erosion and sedimentation control primarily address the control of erosion and the entrapment and on-site removal of sediment resulting from land-disturbing activities. The design requirements of runoff quantity control facilities include features which serve to allow settling out of suspended sediments in runoff. In addition, the requirement to limit the

runoff release rate from a developed site to 50% of the 2-year pre-development rate can be expected to significantly limit stream bank erosion and its resulting sedimentation.

**Metals:** Sumps in drainage structures and in the bottom of detention storage facilities tend to collect a significant proportion of metals contained in storm runoff. In addition, metals often become attached to suspended sediment particles and are then removed as part of the process of treating sediment-laden runoff. However, the smallest particles of sediment are often very difficult to remove and do not readily settle out of stormwater.

**Oil and Grease:** Most oil/water separators currently employed in Kitsap County are either of the spill-control (SC) type or the larger chambered vault (API) type, both of which are ineffective in removing suspended oil droplets from stormwater concentrations typically reported in urban areas. For certain industrial sites where a high concentration of oil is expected, the coalescing plate (CPS) type oil/water separator is the most effective at removing suspended oil droplets. Biofiltration BMP's are generally more effective than oil/water separators in removing suspended oil droplets typically found in urban stormwater.

In addition to oils, oil/water separators and biofiltration swales can remove grease and other heavier petroleum hydrocarbons. Lighter petroleum hydrocarbons, including those present in gasoline and other fuels, are generally less miscible in water and are not removed effectively.

**Nutrients:** Nutrients such as phosphorus and nitrogen are occasionally present in stormwater at levels which can accelerate the eutrophication, or enrichment, process in certain water bodies. Water bodies in which the growth of nuisance algae species is accelerated by loadings of a nutrient are particularly susceptible to negative impacts.

Nutrients are among the most difficult pollutants to remove from stormwater. Sources of phosphorus and nitrogen loading include overuse and improper application of detergents and fertilizers, practices which can be corrected through education and enforcement. It is recommended that the focus of the control of nutrients be public education and restrictions included in residential plat covenants and issuance of land use permits.

The construction of stormwater facilities to treat nutrients in runoff will usually not be required, unless it is determined during the development review process that nutrients in the project storm runoff could accelerate eutrophication of downstream waters, or could pose the risk of nitrate contamination of groundwater. Should nutrient control be required, both source control and runoff treatment BMPs shall be required.

For design criteria for nutrient control facilities, the designer is referred to Washington State Department of Ecology "Stormwater Manual for the Puget Sound Basin".

**Fecal Coliform:** Fecal coliform bacteria level is an indicator of possible pathogenic bacterial contamination. This Manual addresses bacterial contamination of stormwater only in its setback requirements for infiltration facilities from septic drainfields. The intent of these setback requirements is to avoid adverse impacts of infiltration facilities on septic system performance.

## **6.2 WATER QUALITY DESIGN STORM**

The water quality design storm, used for the design of water quality treatment facilities, shall be the 6-month, 24-hour storm event. In that the precipitation data from isopluvial maps is not available for the 6-month, 24-hour storm event, 64% of the 2-year, 24-hour precipitation is considered as equivalent.

## **6.3 BIOFILTRATION BMPs**

There are two types of biofiltration-type BMPs: the biofiltration swale and the vegetated filter strip. A biofiltration swale is a vegetated channel that is sloped like a standard storm drain channel; stormwater enters at one end and exits at the other with treatment provided as the runoff passes through the channel. With vegetated filter strips, the flow is distributed broadly along the width of the vegetated area, and treatment is provided as runoff travels as sheet flow through the vegetation.

Which method to use depends upon the drainage patterns of the site. A vegetated strip would function well where the water can be spread along the length of a parking lot. Gaps in the lot curb provide the entry points. The grade of the parking lot should be flat immediately parallel to the strip.

### **6.3.1 SWALE DESIGN CRITERIA**

Biofiltration swales shall be designed using the Manning Equation for uniform open channel flow as discussed in Chapter 7 Collection and Conveyance Facilities. The swale shall be sized to provide treatment of the post-developed peak flow rate from the water quality design storm, and shall have adequate capacity to pass the post-developed peak flow from a 100 year event without excessive velocity that may cause scouring of the channel. Site conditions may make it advantageous to by-pass events exceeding the water quality design storm. The specific parameters for biofiltration swale design are as follows:

#### **Geometry:**

The swale shall have a trapezoidal cross section, minimum bottom width of 2 feet, maximum bottom width of 8 feet, minimum depth of 1 foot, and maximum side slope steepness of

3H:1V. The longitudinal slope of the swale shall be from 1% to 6%, and the length shall be as required to achieve the minimum residence time listed below.

Water Quality:

The performance of the swale shall be evaluated for treatment of the water quality design storm with a maximum flow depth of 3 inches, a Manning “n” value of 0.20, a maximum flow velocity of 1.0 feet per second, and a minimum residence time of 5.0 minutes (300 seconds). The minimum required length of the swale will be calculated by multiplying the actual flow velocity by the minimum residence time in seconds.

Stability Check:

The stability of the swale shall be evaluated using the developed peak flow rate from the 100 year storm event with a Manning “n” value of 0.035, which assumes that the grass has been knocked over by the flow. If the velocity exceeds 3.5 feet per second, the swale should be enlarged, the contributing flow should be decreased as necessary, or runoff should be bypassed around the facility.

Other Design Considerations:

The biofiltration swale shall be lined with a minimum of 4 inches of Type “A” topsoil according to W.S.D.O.T. Standard Specifications.

The swale should be seeded, fertilized and mulched according to the recommendations of the local Soil Conservation District as follows:

**Seed Mixture:**

- 70% Tall Fescue (Alta, Boyager, Orfawn)
- 20% Perennial Rye
- 10% White Clover

**Application Rate (per 1000 S.F.):**

- 5 lbs. Seed
- 7 lbs. Fertilizer (10-20-20)
- 50 lbs. Wood Fiber Mulch

The contractor may be required to provide the County inspector with documentation for the seed mixture used.

Seeding of the swale should be performed between March 1 - May 15 or August 15 - October 1 according to W.S.D.O.T. Standard Specifications, with the exception that seeding may be performed from May 16 - September 30 if irrigation is provided.

Sodding of the swale will be allowed provided that the sod meets the seed mixture specifications listed above, or if the sod is over seeded with the appropriate seed mixture at the next available planting time.

For swales with longitudinal slopes exceeding 4% and/or swales with bottom widths wider than 4 feet, the use of flow spreaders and check dams should be considered to promote broad shallow flow.

Slope transitions from the required 3:1 side slope of a swale to a steeper slope or wall are generally discouraged due to problems with the steeper slope sloughing into the swale bottom and with the amount of shading that is caused by the wall or slope. Slope transitions should always take place above the 1 foot minimum swale depth, and should normally be separated from the swale by a flat bench. The Director will only allow these slope transitions on a case by case basis.

### **6.3.2 FILTER STRIP DESIGN CRITERIA**

Filter strips shall be designed so that each lineal foot of length will receive runoff from a maximum of 140 square feet of impervious surface. Filter strips shall be sized by providing 0.25 square feet of strip area per square foot of tributary impervious surface.

Curbing for impervious areas contributing to filter strips shall provide a 1 foot gap for every 5 feet of curbing. The transverse slope of impervious areas contributing to filter strips shall be level, and the impervious cross slope shall not exceed 10 percent. Filter strips shall have a minimum cross slope of 2 percent and a maximum cross slope of 15 percent. Runoff from filter strips shall be intercepted at the bottom of the strip by a swale sized to convey the peak rate of runoff for the 100-year storm event.

## **6.4 WET PONDS AND WET VAULTS/TANKS**

Wet ponds and wet vaults/tanks utilize permanent pools of water to treat stormwater runoff. The primary treatment mechanism is settling of sediments which results in a reduction in total suspended solids, including soil particles as well as insoluble metals which attach to the particles. In wet ponds, especially those containing shallow vegetated areas, additional treatment is achieved through microbial decomposition and plant uptake of certain nutrients and other pollutants.

## 6.4.1 WET POND DESIGN

### SIZING WET PONDS

The permanent pool volume shall be equal to the runoff volume generated by the post development 6-month, 24-hour design storm from the entire contributing basin including any off-site contributing areas. It is not necessary to vegetate the permanent pool, but establishment of a shallow marsh system can provide additional pollutant removal capabilities.

A minimum permanent pool depth of 3 feet is recommended so that re-suspension of trapped pollutants is inhibited. A maximum depth of 6 feet is recommended. Permanent pools deeper than 6 feet could potentially contaminate ground water. Also, deeper ponds can stratify and create anaerobic conditions that cause pollutants which are normally bound in the sediment (e.g., metals and phosphorus) to re-solubilize; their release back to the water column can seriously affect the effectiveness of the BMP and also create nuisance conditions.

Ponds designed to provide detention may be deeper than 6 feet as long as the permanent pool volume provided for runoff treatment does not exceed 6 feet.

### POND CONFIGURATION AND GEOMETRY

Wet ponds shall be multi-celled, with at least two cells, and preferably three. The cells should be approximately equal in size. The first cell should be easily accessible for maintenance purposes.

Long, narrow, and irregularly shaped ponds are preferred, as these configurations are less prone to short-circuiting and tend to maximize available treatment area. The length-to-width ratio should be at least 3:1 and preferably 5:1. Irregularly shaped ponds may perform more effectively and will have a more natural appearance.

The inlet and outlet should be at opposite ends of the pond where feasible. If this is not possible, then baffles can be installed to increase the flow path and water residence time.

The pond bottom shall be level to facilitate sedimentation.

All ponds with a permanent pool depth exceeding 18-inches, or side slopes steeper than 4H:1V, shall be fenced. Interior side slopes above the freeboard elevation of unfenced ponds may be as steep as 2H:1V provided that a 10' wide safety bench is provided at the point of slope transition. For safety reasons, all ponds with a permanent pool depth exceeding 18-inches shall have maximum side slopes of 3H:1V in addition to perimeter fencing. Exterior pond side slopes shall be no steeper than 2H:1V.



Pond walls may be retaining walls, provided that 1) the design is prepared and stamped by a structural engineer registered in the State of Washington, 2) that they are constructed of reinforced concrete, 3) that at least 25 percent of the pond perimeter will be a vegetated soil slope of not greater than 3H:1V, 4) that maintenance access is provided to the bottom of the pond, and 5) that a fence is provided around the entire perimeter of the pond.

### **ACCESS**

Pond access requirements shall be the same as for any pond (see Chapter 5, Stormwater Quantity Control Facilities).

### **SITE CONSTRAINTS**

Site constraints are any restrictions such as property lines, easements, structures, etc. that impose constraints on development. Use of a site may also be constrained by governmental ordinances or policies concerning sensitive areas. These should also be reviewed for specific application to the proposed development.

The minimum setbacks for wet ponds, as measured from the maximum permanent pool water surface, are the same as those listed in Chapter 5 for detention ponds with the following exceptions:

- 200 feet from any slope steeper than 30%; this distance may be reduced based on a geotechnical engineering report.
- 100 feet from existing or proposed septic drainfields
- Locating a wet pond within 100 feet of a neighboring property line may require the developer to secure easements from adjacent owners due to the fact that the location of the wet pond may be an encumbrance on adjacent properties with regard to future septic drainfield locations.

### **DAM SAFETY**

Failure of an impoundment structure can cause significant property damage and loss of life. Such structures should be designed only by professional engineers registered in the State of Washington who are qualified and experienced in impoundment design. For ponds impounding more than 10 acre feet of water, the design may require review and approval by the Department of Ecology and other agencies.

## 6.4.2 WET VAULT AND WET TANK DESIGN

### LIMITATION

Wet vaults and wet tanks are only recommended for small areas (1 acre or less) due to lack of biological treatment and maintenance difficulties. These facilities should only be used as a last resort for water quality.

### PURPOSE AND DEFINITION

Wet vaults and tanks are underground facilities used for the storage of surface water and are typically constructed from reinforced concrete (vaults) or pipe (tanks). Wet vaults and tanks are designed to provide runoff treatment through the use of a permanent pool of water. Stream bank erosion control can also be provided by adding live storage volume above the permanent pool. Figure 5-15, Detention Tank Detail, and Figure 5-16, Detention Vault Detail, illustrate tank/vault systems.

If a wet vault/tank is designed to provide runoff treatment but not stream bank erosion control it should be located off line from the primary conveyance/detention system. Flows above the peak water quality design storm (6 month recurrence, 24 hour duration) should bypass the facility in a separate conveyance to the point of discharge. A mechanism should be provided at the bypass point to take the facility off line for maintenance purposes.

### SIZING CRITERIA

The sizing criteria for a wet vault/tank shall be the same as for a wet pond.

### GEOMETRICS

The vault shall be divided into a minimum of 2 cells using baffles with the first cell occupying about one third of the area. The top of the baffle walls should be coincident with the depth of the permanent pool.

The length-to-width ratio at the design water surface elevation shall be no less than 3:1 and preferably 5:1.

If the vault/tank dead storage volume exceeds 3000 gallons, a low point maintenance drain line must be installed to allow gravity drain for maintenance. The drain line shall be at least 8 inches in diameter, isolated by a valve or shear gate (situated such that water pressure acts to seal gate) and located no closer than 6 inches from the vault/tank bottom.

### MATERIALS AND STRUCTURAL STABILITY

The material and structural stability design for wet vaults/tanks constructed of concrete shall follow the recommendations for detention tanks and vaults contained in Chapter 5. Steel or other metal tanks are not approved for use as wet tanks or wet vaults.

## ACCESS

Access requirements for wet vaults/tanks are the same as those for detention tanks and vaults as listed in Chapter 5.

## **6.5 OIL/WATER SEPARATORS**

Oil/Water Separators have limited application in stormwater treatment because their treatment mechanisms are not well suited to the characteristics of stormwater runoff (i.e., highly variable flow with high discharge rates, turbulent flow regime, low oil concentration, high suspended solid levels). In addition, oil/water separators frequently require intensive maintenance, which reduces their feasibility as a stormwater treatment BMP. The primary use of oil/water separators is in cases where oil, or petroleum product, spills are a concern. In these cases, a spill control (SC) separator shall be specified. In most other cases, other BMPs are more appropriate for controlling oil. Source controls should be considered the first option to controlling such pollutants, and may negate the need for additional treatment.

Sand filtration and other absorbent materials are being investigated as alternatives to oil/water separators. While there is limited data on the effectiveness of these to remove oil, they should be considered by the designer.

Other than to capture spills, the use of oil/water separators will be restricted to those development sites that have a potential for high oil and grease loadings. The reader is encouraged to refer to the Department of Ecology's "Stormwater Management Manual for the Puget Sound Basin" for source control and stormwater treatment BMPs required for specific business and industrial uses. There may also be additional cases where high vehicular traffic and sensitive downstream conditions may warrant the use of an oil/water separator. These will be identified by the Director on a case by case basis.

Three common types of oil/water separators are described below:

- Spill Control (SC-type)
- American Petroleum Institute (API-type)
- Coalescing Plate Separator (CPS-type)

The use of other types of oil/water separators is permitted when documented performance data is provided demonstrating the ability to conform with discharge requirements. Because most oil/water separators are manufactured units, only limited design information is provided in this chapter. In those cases where an oil/water separator is considered, the engineer is encouraged to contact the appropriate manufacturer or supplier. The reader is also encouraged to refer to the Department of Ecology's "Stormwater Management Manual for the Puget Sound Basin" for specific design information.

WSDOE guidelines require that stormwater have no visible sheen, average less than 10-mg/l of oil and grease daily, and at no time exceed a daily maximum of 15-mg/l. Regardless of the separator type, the following design criteria should be considered:

1. Under no circumstances should any portion of the contributing drainage area contain disturbed pervious areas which can be sources of sediment.
2. If required, separators should precede all other treatment and streambank erosion control BMPs.
3. Appropriate access must be provided for efficient inspection and maintenance.
4. Stormwater from rooftops, and other impervious surfaces not likely to be contaminated by oil shall not discharge to an oil/water separator.
5. Any stormwater pump mechanism required shall be installed downstream of the separator to prevent oil emulsification.
6. Oil/water separators shall have an appropriate forebay to collect floatable and larger settleable solids. The forebay surface area shall not be less than 20-sq. ft. per 10,000-sq. ft. of area contributing to the separator.
7. Separators shall be sized for the 6-month, 24-hour design storm. Larger storms shall be diverted around the separator by the use of an appropriate diversion/bypass structure.

### **SPILL CONTROL OIL/WATER SEPARATORS**

Spill control (SC) oil/water separators are required for all development sites that include areas subject to vehicular traffic. These devices are intended to prevent the discharge of accidental oil spills into downstream drainage systems or stream courses.

An SC-type oil/water separator is a simple underground vault or manhole with a tee or down turned elbow outlet. The SC-type oil/water separator is effective at retaining only small spills. They are not intended to remove diluted oil droplets dispersed into stormwater from oil-contaminated pavement.

For small projects where 8" diameter pipe is used, the SC oil/water separator may consist of a removable, down turned 8" elbow located in a Type I catchbasin. For larger sites where 12" or larger diameter pipe is used, the SC oil/water separator shall consist of a tee as shown in Chapter 5, Figure 5-19, located in a Type II catchbasin. In some applications, the ability to isolate an SC oil/water separator from the downstream system may be required.

## API-TYPE OIL/WATER SEPARATORS

The API-Type oil/water separator is a chamber designed to provide flow conditions that are sufficiently quiescent to allow globules of free oil to rise to the water surface and coalesce into a separate oil phase. This general type of unit is typically assumed to have no short circuiting, turbulence, or eddies. Sizing of an API-Type oil/water separator is based upon the vertical rise rate of oil globules, and its relationship to the vault surface loading rate. The reader is referred to the WSDOE "Stormwater Manual for the Puget Sound Basin", and American Petroleum Institute Publication 421 (1990) for specific design information.

## CPS-TYPE OIL/WATER SEPARATORS

The coalescing plate oil/water separator (CPS) has a series of parallel inclined plates that act to increase surface area by the sum of the horizontal projections of the plates added. Oil collected from CPS systems typically have a lower water content than conventional separators, and an overall higher removal rate. The extra surface area provided by a CPS oil/water separator may also be attractive where space is limited.

Manufacturers of CPS oil/water separators provide standard plate packages which are rated at a particular flow. Because the manufacturer's flow rating is different than conditions found on individual sites, the engineer must compare the plate surface area requirements with the following:

$$A_p = \frac{Q}{\text{RiseRate}}$$

Where  $A_p$  = projected surface area of the plate (ft.<sup>2</sup>); note that the actual surface area,  $A_a$  =  $A_p / \cosine H$ .

H = angle of the plates with the horizontal in degrees, usually varies from 45-60 degrees.

Q = design flow (cfm).

Rise rate - recommend using 0.033 ft/min.

The determination of plate surface area requirements and number of plates required is theoretically based and is standard for most parallel plate configurations.

The width, depth, and length of the plate pack and the chamber in which the plate pack is placed is completely flexible and is a function of the plate sizes provided by the particular pack manufacturer and standard size vaults that are available for small sites.

## **6.6 Experimental Water Quality BMP's**

Kitsap County Code title 12 classifies all water quality BMP's other than wet ponds/vaults, oil/water separators, and biofilters as experimental. Until the Washington State Department of Ecology establishes a set of criteria to evaluate emerging technologies the following shall apply:

### **6.6.1 Proposed BMP is from another jurisdiction's design standards (i.e. King County, WSDOT, etc.):**

The design engineer shall reference the design standard used and if possible submit a copy of the design specifications with the drainage report (see chapter 2.3.3).

### **6.6.2 Proprietary Products (filter media, centrifugal devices, settling devices, etc.):**

The design engineer shall provide data from the manufacturer within the drainage report (chapter 2.3.3) that indicates the water quality device meets these specifications:

- 1) Removal of 80% of total suspended solids (TSS) for influent concentrations greater than 100 mg/L, but less than 200 mg/L.
- 2) For concentrations less than 100 mg/L, the device achieves an effluent goal of 20mg/L
- 3) Typical particle distribution for the tests used to obtain these results

The design engineer shall provide a letter from the device manufacturer or technical assistance representative that states:

- 1) The device (include model number or configuration) is properly sized for the intended project site (include sizing rationale)
- 2) The device installation proposal meets all hydraulic requirements of the device (head loss, hydraulic driving head, etc)
- 3) Pollutants the device is designed to remove other than TSS

## CHAPTER 7

# COLLECTION AND CONVEYANCE FACILITIES





# **CHAPTER 7**

## **COLLECTION AND CONVEYANCE FACILITIES**

### **CONTENTS**

<b>7.1</b>	<b>PURPOSE AND SCOPE</b>	<b>7-1</b>
<b>7.2</b>	<b>GENERAL DESIGN CRITERIA</b>	<b>7-1</b>
7.2.1	ROUTE DESIGN	7-1
7.2.2	EASEMENTS AND SETBACKS	7-2
7.2.3	MAINTENANCE ACCESS	7-2
7.2.4	DATUM	7-3
<b>7.3</b>	<b>DETERMINATION OF DESIGN FLOW</b>	<b>7-3</b>
7.3.1	DESIGN EVENT	7-3
7.3.2	DESIGN METHODOLOGY	7-3
7.3.3	RATIONAL METHOD	7-3
<b>7.4</b>	<b>CAPACITY ANALYSIS</b>	<b>7-8</b>
<b>7.5</b>	<b>DESIGN CRITERIA FOR OPEN CHANNELS</b>	<b>7-9</b>
7.5.1	GEOMETRY	7-9
7.5.2	FREEBOARD	7-9
7.5.3	CHANNEL LINING	7-9
7.5.4	CHECK DAMS	7-13
7.5.5	CHANNEL LOCATION	7-13
7.5.6	BIOFILTRATION SWALES	7-13
<b>7.6</b>	<b>DESIGN CRITERIA FOR CULVERTS</b>	<b>7-13</b>
7.6.1	ACCEPTABLE PIPE MATERIAL	7-13
7.6.2	HEADWALLS	7-15
7.6.3	GENERAL CULVERT DESIGN CRITERIA	7-15
<b>7.7</b>	<b>DESIGN CRITERIA FOR PIPE SYSTEMS</b>	<b>7-17</b>
7.7.1	ACCEPTABLE PIPE MATERIAL	7-17
7.7.2	PIPE ALIGNMENT	7-17
7.7.3	CONNECTIONS TO PIPE SYSTEMS	7-17
7.7.4	VERTICAL ALIGNMENT OF PIPES AT STRUCTURES	7-17



7.7.5	DOWNSIZING OF PIPES	7-18
7.7.6	GENERAL PIPE CRITERIA	7-18
7.7.7	STEEP SLOPE INSTALLATION	7-19
7.7.8	PRIVATE SECONDARY DRAINAGE SYSTEMS	7-19
7.8	DESIGN CRITERIA FOR INLET STRUCTURES	7-19
7.9	DESIGN CRITERIA FOR OUTFALLS	7-21
7.10	STORMWATER PUMPS	7-21
7.11	BRIDGES	7-22

---

## FIGURES & TABLES

### INDEX

<u>Figure</u>	<u>Title</u>	<u>Page</u>
Figure 7-1	RAINFALL INTENSITY-DURATION CURVES	7-6
Figure 7-2	AVERAGE VELOCITIES	7-7
Figure 7-3	CONCRETE END PROTECTION	7-16
Figure 7-4	THRU-CURB INLET DETAIL	7-20
Table 7-1	RUNOFF COEFFICIENTS-"C" VALUES FOR THE RATIONAL METHOD	7-5
Table 7-2	VALUES OF THE ROUGHNESS COEFFICIENT, "n", FOR PIPES	7-10
Table 7-3	VALUES OF THE ROUGHNESS COEFFICIENT, "N" FOR OPEN CHANNELS	7-11
Table 7-4	ROCK PROTECTION AT OUTFALLS	7-12
Table 7-5	APPROVED PIPE MATERIALS	7-14



# **COLLECTION AND CONVEYANCE FACILITIES**

## **7.1 PURPOSE AND SCOPE**

This chapter presents Kitsap County policy concerning the selection, design, sizing and construction of stormwater collection and conveyance facilities, including open channels and ditches, culverts, piped storm sewers, inlet and junction structures, and outfalls. Some conveyance facilities function both as water quality facilities and as conveyance facilities (e.g. biofiltration swales and oil/water separators). Design criteria for these facilities is found in Chapter 6, Stormwater Quality Control Facilities. Some outfall structures also function as part of runoff control facilities (e.g. control manholes, emergency overflow spillways, infiltration trenches and flow dispersal trenches). Design criteria for these facilities is found in Chapter 5, Stormwater Quantity Control Facilities.

In general, Kitsap County favors the use of open channel surface drainage rather than piped storm sewers to convey stormwater. Vegetated open channels significantly improve water quality, and are also easier to inspect and maintain than piped systems. It is recognized, however, that with the urbanization of the county comes the need for sidewalks and curbing which often results in the necessity to install piped storm sewers. Kitsap County will continue to promote the use of open channels wherever possible and encourages the project designer to consider alternative innovative approaches for incorporating open channels into their designs.

This manual provides established standards for engineering design, suitability of purpose and method of analysis. In addition, the Washington State Department of Transportation/APWA Standard Specifications for Road, Bridge and Municipal Construction, most recent edition, and the Washington State Department of Ecology Stormwater Management Manual for the Puget Sound Basin (Technical Manual) can be considered approved standards for design and construction unless differing standards are specifically required in this manual. The King County Surface Water Design Manual is an excellent reference containing in-depth discussion on most of the contents of this chapter.

## **7.2 GENERAL DESIGN CRITERIA**

### **7.2.1 ROUTE DESIGN**

New conveyance system alignments on private property must be located in drainage easements that are adjacent and parallel to property lines, located entirely on one property and not split between adjacent properties.

## **7.2.2 EASEMENTS AND SETBACKS**

Drainage easements shall be provided in a proposed development for all stormwater facilities that are not located in public rights-of-way or tracts. Said drainage easements shall be granted to the parties responsible for providing on-going maintenance of the stormwater facilities.

Stormwater facilities that are to be maintained by Kitsap County, together with maintenance access roads to said facilities, shall be located in public right-of-way, separate tracts dedicated to Kitsap County, or drainage easements located in designated Open Space. The exception is for stormwater conveyance pipes that may be located within easements on private property, provided that all catch basins can be accessed without entering private property.

All runoff from impervious surfaces, roof drains, and yard drains shall be directed so as not to adversely affect adjacent properties. Wording to this effect shall appear on the face of all final plats/P.U.D.s, and shall be contained in any covenants required for a development.

All drainage easements, public and private, must have a minimum width of 15', with the exception that private secondary roof and yard drain systems may be located within 10' easements. All pipes must be located within the easement so that each pipe face or top edge of channel is no closer than 5' from its adjacent easement boundary (secondary roof and yard drain pipes shall be centered in the easement). Open channels shall be located within the easement so that the water surface elevation at the top of freeboard is no closer than 5' from each easement boundary. For pipes larger than 5' in diameter and for channels having a top width at freeboard wider than 5', the easement width must be accordingly larger than the minimum 15' in order to meet the required setbacks from the easement boundaries.

The minimum required building setback from all drainage easements is 5' from the easement line and 10' from the drainage structure, whichever is greater.

## **7.2.3 MAINTENANCE ACCESS**

Maintenance access must be provided for all manholes, catch basins, vaults, or other drainage facilities that are to be maintained by Kitsap County. It is not generally necessary to provide vehicular access along the entire length of a drainage pipe or swale as long as access is provided at each end. Maintenance access shall consist of an access easement and a constructed access road, with turn-around if necessary. Access roads shall be constructed as specified in Chapter 5, Stormwater Quantity Control Facilities.

## **7.2.4 DATUM**

A datum tied to a section corner shall be used in the design of drainage systems. All datums shall be either NGVD29 or NAD83.

## **7.3 DETERMINATION OF DESIGN FLOW**

### **7.3.1 DESIGN EVENT**

All conveyance systems must be designed, at a minimum, to convey a peak stormwater rate resulting from a 100-year frequency storm event, EXCEPT:

- o Other governing authorities may require that the design of some structures be based on a larger storm event.
- o Some water quality facilities are designed to function primarily under low flow conditions. However, unless higher flows are diverted from these water quality facilities, they must also be designed to have sufficient conveyance capacity for 100-year storm flow rates.

### **7.3.2 DESIGN METHODOLOGY**

For all existing and proposed conveyance systems receiving drainage from a contributing area of 25 acres or less and having a time of concentration of 100 minutes or less, the Rational Method may be used as described in this Chapter. For all other conditions an approved hydrograph method as described in Chapter 5, Stormwater Quantity Control Facilities, must be used.

### **7.3.3 RATIONAL METHOD**

The traditional Rational Method, as described in most engineering manuals, is preferred by Kitsap County for designing systems serving smaller contributing basins primarily because it tends to provide higher runoff rates than hydrograph methods do, resulting in a more conservative design with a built-in factor of safety.

With the traditional Rational Method, peak runoff rates can be determined using the following formula:

$$Q = C I A$$

where

Q	=	Runoff in cubic feet per second
C	=	Runoff coefficient
I	=	Rainfall intensity in inches per hour
A	=	Contributing area in acres

The runoff coefficient (C) should be based on Table 7-1, Runoff Coefficients - 'C' Values for the Rational Method.

The rainfall intensity (I) should be based on Figure 7-1, Rainfall Intensity-Duration Curves, prepared by the U.S. Weather Bureau for the Mayfield - Bremerton - Port Orchard - Sumner areas.

The rainfall intensity is based on the time of concentration, in minutes. The time of concentration should be computed from the most hydraulically distant point in the contributing basin to the structure being designed, using the formula

$$T = \frac{L}{60V}$$

where T = Time of concentration, in minutes  
L = Length of run, in feet  
V = Velocity, in feet per second

Velocity can be estimated using Figure 7-2, Average Velocities For Estimating Travel Time For Overland Flow.

An initial collecting time of 10 minutes for unpaved areas and 5 minutes for paved areas may be taken at the most hydraulically distant point of flow. From this point, the overland flow time for each significantly different slope and overland flow condition must be calculated. Once the runoff has reached the drainage facility being sized, the total time of concentration, T<sub>c</sub>, is calculated by summing the concentration time of each individual run plus the initial collecting time:

$$T_c = T_1 + T_2 \dots T_N + \text{Initial Collecting Time}$$



Table 7-1 RUNOFF COEFFICIENTS - "C" VALUES FOR THE RATIONAL METHOD

<b>UNDEVELOPED LAND</b>	<b>"C" FLAT (0-5%)</b>	<b>"C" ROLLING (&gt;5%)</b>
Wood & Forest	0.05	0.10
Sparse Trees & Ground Cover	0.10	0.15
Light Grass to Bare Ground	0.15	0.20
<b>DEVELOPED AREA</b>		
Pavement & Roofs	0.90	0.90
Gravel Roads & Parking Lots	0.75	0.80
City Business	0.85	0.90
Apartment Dwelling Areas	0.80	0.85
Industrial Areas (Heavy)	0.70	0.80
Industrial Areas (Light)	0.60	0.70
Earth Shoulder	0.50	0.50
Playground	0.25	0.30
Lawns, Meadows & Pastures	0.20	0.25
Parks & Cemetery	0.15	0.20
<b>SINGLE FAMILY RESIDENTIAL AREAS (Density is in dwelling units per gross acre (DU/GA))</b>		<b>"C"</b>
1.0 DU/GA		0.30
2.0 DU/GA		0.36
3.0 DU/GA		0.42
4.0 DU/GA		0.48
6.0 DU/GA		0.60
9.0 - 15.0 DU/GA		0.7

Figure 7-1 RAINFALL INTENSITY-DURATION CURVES

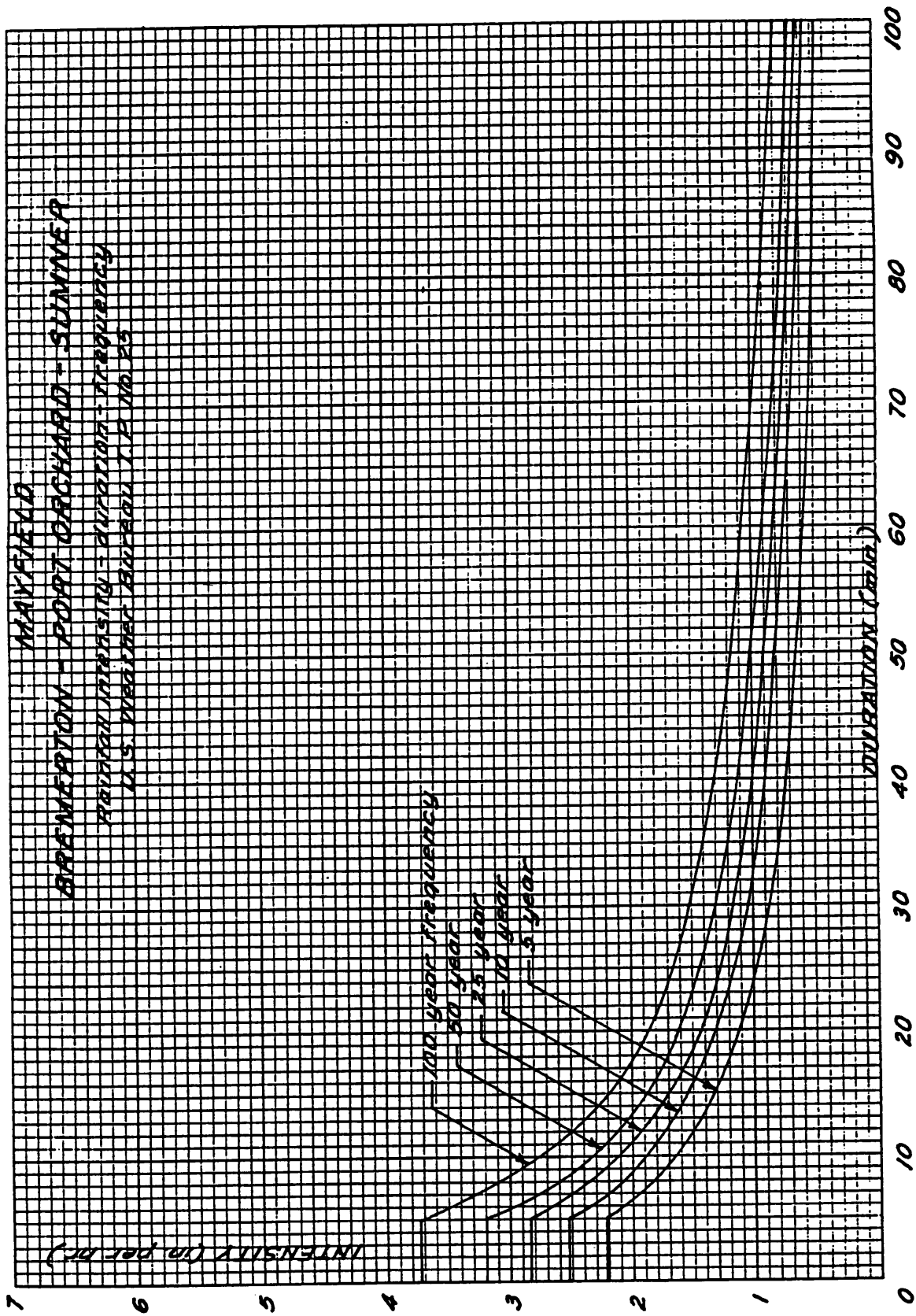
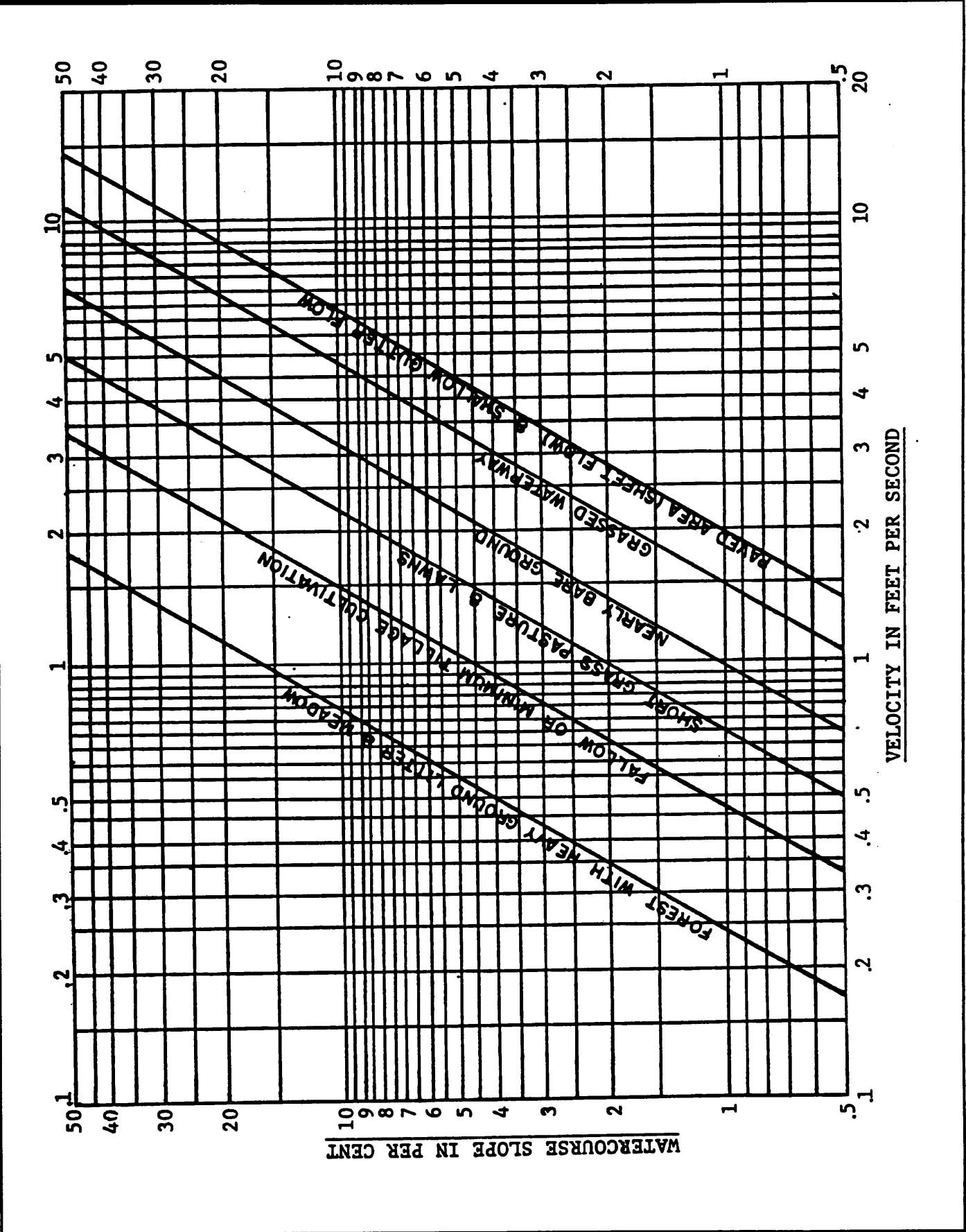


Figure 7-2 AVERAGE VELOCITIES



## 7.4 CAPACITY ANALYSIS

The capacity of pipe systems and open channels can often be estimated using the Manning equation for steady uniform flow as follows:

$$Q = \frac{1.486}{n} AR^{\frac{2}{3}} S^{\frac{1}{2}}$$

$$V = \frac{1.486}{n} R^{\frac{2}{3}} S^{\frac{1}{2}}$$

where

Q	=	Capacity, in cubic feet per second
V	=	Velocity, in feet per second
n	=	Roughness coefficient
A	=	Area of cross section, in square feet
R	=	Hydraulic radius
S	=	Slope, in feet per foot

The hydraulic radius (R) is:

$$R = \frac{A}{P}$$

where

R	=	Hydraulic radius
A	=	Area of cross section, in square feet
P	=	Wetted perimeter, in feet

Typical values for the Manning roughness coefficient “n” are given in Tables 7-2 and 7-3.

This capacity estimate using the Manning equation may be acceptable for final design purposes provided that the conveyance system contains no flow restrictions such as tailwater or abrupt changes in channel cross section or slope that might cause non-uniform flow. It should also be noted that the Manning equation does not take into account entrance, exit, bend and junction losses within catch basins or manholes.

To estimate the capacity of a conveyance system where uniform flow is not expected or where losses within the system may cause surcharging of water, it is recommended that a Backwater Analysis be performed on the system. Furthermore, when estimating the capacity of a culvert, it is often necessary to use alternate methods of analysis to account for various submerged and unsubmerged flow conditions.

It is the responsibility of the design engineer to determine the appropriate method of analysis in determining the capacity of the proposed conveyance system. Many engineering manuals, handbooks and computer software are available to assist the design engineer.

## **7.5 DESIGN CRITERIA FOR OPEN CHANNELS**

As previously stated, open channels are the preferred method of collecting and conveying storm runoff. Where space and topography permit, it is encouraged that broad, shallow, vegetation-lined channels be constructed to promote water quality. However, it is important to recognize that water quality is also degraded by sedimentation resulting from the erosion of channels. For this reason, Kitsap County will strictly adhere to the design criteria contained in this chapter concerning the rock armoring of channels subject to high velocities of flow.

### **7.5.1 GEOMETRY**

Channel side slopes shall be no steeper than 2:1 for undisturbed ground (cuts), as well as for disturbed ground (embankments). All constructed channel slopes shall be compacted to a minimum 95% compaction.

### **7.5.2 FREEBOARD**

Channels shall be designed to provide sufficient freeboard so as not to saturate any adjacent public road base with 100 year peak flows. A minimum of 1 foot of freeboard is recommended, but in no case should channel freeboard be less than 0.5 feet.

### **7.5.3 CHANNEL LINING**

Channels having a flowline slope of 6% or greater OR having a peak design velocity exceeding 5 feet per second shall be rock-lined with rip rap or shall incorporate energy dissipation devices designed by a qualified professional engineer. Rip rap shall conform to the standards contained in Table 7-4, Rock Protection at Outfalls. As an alternative, the engineer may submit computations for the design of rip rap to resist the overturning influence of flowing water.

Table 7-2 VALUES OF THE ROUGHNESS COEFFICIENT, "n", FOR PIPES

<b>TYPE OF PIPE MATERIAL</b>	<b>"n"</b>
Concrete	0.012
Ductile Iron	0.012
Corrugated Metal (CMP) - Annular - 2-2/3" x 1/2"	0.024
Corrugated Metal (CMP) - Annular - 3" x 1"	0.027
Corrugated Metal (CMP) - Annular - 6" x 2"	0.030
Corrugated Metal (CMP) - Helical - 2-2/3" x 1/2"	
12 inch diameter	0.011
18 inch diameter	0.013
24 inch diameter	0.015
36 inch diameter	0.018
48 inch diameter	0.020
60 inch diameter and larger	0.021
Corrugated High Density Polyethylene (CPEP) - single wall	0.024
Corrugated High Density Polyethylene (CPEP) - smooth wall	0.012
Spiral Rib Metal (SRP)	0.011
Polyvinyl Chloride (PVC)	0.011
High Density Polyethylene (HDPP) - butt fused	0.009

Table 7-3 VALUES OF THE ROUGHNESS COEFFICIENT, "N" FOR OPEN CHANNELS

Type and Channel and Description	Manning's "n" (Normal)	Type and Channel and Description	Manning's "n" (Normal)
<b>A. Constructed Channels</b>		<b>6. Sluggish reaches, weedy deep pools</b>	<b>0.070</b>
a. Earth, straight & uniform		<b>7. Very weedy reaches, deep pools, or floodways with heavy stand of timber and underbrush</b>	<b>0.100</b>
1. Clean, recently completed	0.018		
2. Gravel, uniform section, clean	0.025		
3. With short grass, few weeds	0.027		
b. Earth, winding and sluggish	0.025	b. Mountain streams, no vegetation in channel, banks usually steep, trees and brush along banks submerged at high stages	
1. No vegetation	0.025	1. Bottom; gravel, cobbles, and few boulders	0.040
2. Grass, some weeds	0.030	2. Bottom; cobbles with large boulders	0.050
3. Dense weeds or aquatic plants in deep channels	0.035	B-2. Flood Plains	
4. Earth bottom and weedy banks	0.030	a. Pasture, no brush	
5. Stony bottom and weedy banks	0.035	1. Short grass	0.030
6. Cobble bottom and clean sides	0.040	2. High grass	0.035
c. Rock lined		b. Cultivated areas	
1. Smooth and uniform		1. No crop	0.030
2. Jagged and irregular	0.080	2. Mature row crops	0.035
d. Channels not maintained, weeds and brush uncut	0.050	3. Mature field crops	0.040
1. Dense weeds, high as flow depth	0.100	c. Brush	
2. Clean bottom, brush on sides		1. Scattered brush, heavy weeds	0.050
3. Same, highest stage of flow		2. Light brush and trees	0.060
4. Dense brush, high stage		3. Medium to dense brush	0.070
B. Natural Streams	0.030	4. Heavy, dense brush	0.100
B1. Minor streams (top width at flood stage < 100 ft.)	0.035	d. Trees	
a. Streams on plain		1. Dense willows, straight	0.150
1. Clean, straight, full stage no rifts or deep pools	0.040	2. Cleared land with tree stumps, no sprouts	0.040
2. Same as above, but more stones and weeds	0.040	3. Same as above, but with heavy growth of sprouts	0.060
3. Clean, winding, some pools and shoals	0.050	4. Heavy stand of timber; a few down trees, little undergrowth, flood stage below branches	0.100
4. Same as above, but some weeds		5. Same as above, but with flood stage reaching branches	0.120
5. Same as 4, but more stones			

Note: These "n" values are "normal" for use in analysis of channels. For conservative design for channel capacity the "maximum" values listed in other references should be considered. For channel bank stability the minimum values should be considered.

Table 7-4 ROCK PROTECTION AT OUTFALLS

ROCK PROTECTION AT OUTFALLS						
Discharge Velocity At Design Flow (fps)		REQUIRED PROTECTION				
Greater than	Less than or equal to	Minimum Dimensions				
		Type	Thickness	Width	Length	Height
0	5	Rip Rap*	1 ft.	Diameter + 6 ft.	8 ft. or 4X Dia. whichever is greater	Crown + 1 ft.
5	10	Rip Rap**	1 ft.	Diameter + 6 ft. or 3X dia., whichever is greater	12 ft. or 4X dia. whichever is greater	Crown + 1 ft.
10	20	Gabion Outfall	1 ft.	(As required)	(As required)	Crown + 1 ft.
20	N/A	Engineered Energy Dissipator Required				

\* Rip rap shall be in accordance with section 9-13.1 of the WSDOT/APWA Standard Specifications. Rip rap to be reasonably well graded with rock gradation as follows:

Passing 8 inch square sieve 100% Passing 6 inch square sieve 40-60% Passing 2 inch square sieve 0-10%	} or { } or { } or {	Maximum stone size 8" Medium stone size 6" Minimum stone size 2"
---	----------------------------	--

\*\* Rip rap to be reasonably well graded with rock gradation as follows:

Maximum stone size 24" (nominal diameter)  
 Median stone size 16"  
 Minimum stone size 4"

Note: Rip rap sizing governed by side slopes on outlet channel, assumed to be ~3:1.



#### **7.5.4 CHECK DAMS**

Check dams are not generally recommended for use in open channels due to the problems they pose for routine maintenance operations. However, check dams are recommended for use in temporary channels as an erosion and sedimentation control device (see Chapter 3, Erosion and Sedimentation Control) and for stepping down channels being used for biofiltration (see Chapter 6, Stormwater Quality Control Facilities). Where check dams are proposed, they shall be spaced at a maximum 2' elevation intervals.

#### **7.5.5 CHANNEL LOCATION**

Open channels are not recommended through residential lots, particularly at the rear of lots away from the street. Channels in these locations are very difficult to access for maintenance and tend to be misused or altered by property owners. Kitsap County prefers that open channels be, instead, located in rights-of-way and open spaces where possible. If stormwater must be conveyed through an individual residential lot, it should be piped.

#### **7.5.6 BIOFILTRATION SWALES**

It is encouraged that every opportunity be taken to design open channels to provide biofiltration throughout an entire drainage system and not just at the downstream end of the system. Engineers are also encouraged to consider innovative means of collecting and conveying runoff so as to incorporate biofiltration into the drainage system design. See Chapter 6, Stormwater Quality Control Facilities, for more information concerning biofiltration.

### **7.6 DESIGN CRITERIA FOR CULVERTS**

Culverts, for the purposes of this manual, are single runs of pipe that are open at each end and that do not have structures such as catch basins or manholes. It should be noted that culverts designed for fish passage, as governed by the Department of Fish and Wildlife, often require additional design considerations such as depth of flow and velocity that may differ considerably from the design requirements included in this chapter.

#### **7.6.1 ACCEPTABLE PIPE MATERIAL**

The pipe materials contained in Table 7-5 are approved for use for culverts, subject to the limitations indicated. Pipe material specifications, joints and protective treatments shall be in accordance with WSDOT/APWA Standard Specifications.

## Table 7-5 APPROVED PIPE MATERIALS

### Materials allowed for storm drainage conveyance systems:

- Plain concrete (12" diameter only, and only for driveway culverts).
- Ductile Iron, Class 50 or 52.
- Reinforced concrete pipe.
- Galvanized corrugated iron or steel pipe (with Treatment 1 through 6).
- Galvanized steel spiral rib pipe (with Treatment 1 through 6).
- Corrugated aluminum pipe.
- Aluminum spiral rib pipe.
- Aluminized Type 2 corrugated steel (meeting AASHTO treatment M274 and M56).
- Corrugated high density polyethylene pipe (CPEP) - smooth interior (maximum 24" diameter) meeting AASHTO standard M-294.
- Corrugated high density polyethylene pipe (CPEP) - single wall, fully corrugated meeting AASHTO standard M-252 (permitted only outside public right-of-way, for use in temporary storm sewer systems, and as downspout/footing/yard drain collectors on private property).
- Polyvinyl chloride (PVC) sewer pipe (SDR 35, meeting requirements of ASTM D3034) (permitted only outside public right-of-way and only in privately maintained drainage systems, and with a minimum 3' of cover).
- High density polyethylene pipe (HDPP) (only 12" to 24" diameter permitted in right-of-way). Pipe must comply with requirements of Type III C5P34 per ASTM D1248 and have the PPI recommended designation of PE3408 and have an ASTM D3350 cell classification of 345434C or 345534C. Pipe shall have a manufacturer's recommended hydrostatic design stress rating of 800 psi based on a material with a 1600 psi design basis determined in accordance with ASTM D2837-69. Pipe shall have a suggested design working pressure of 50 psi at 73.4 degrees F and SDR of 32.5.

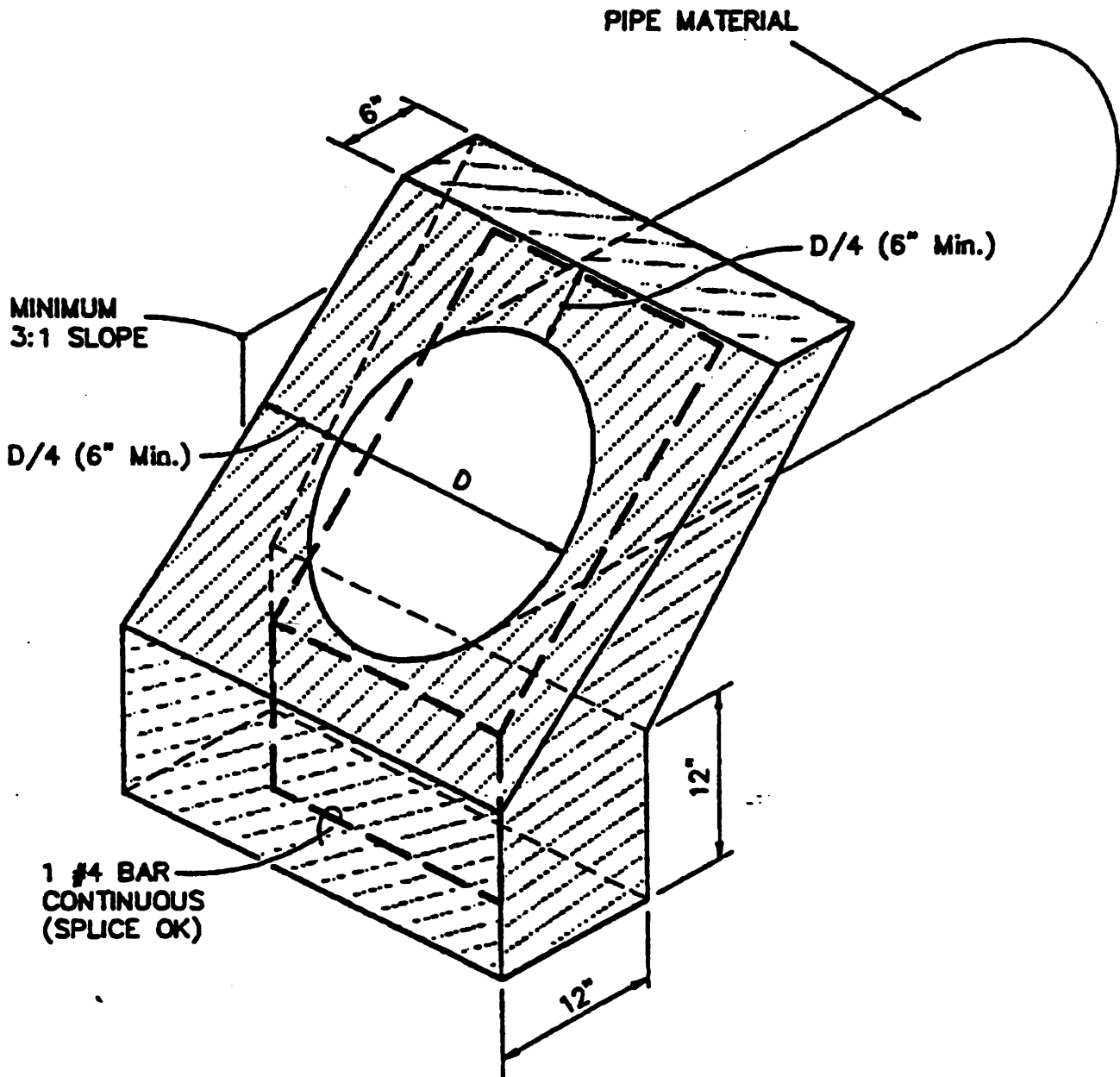
## **7.6.2 HEADWALLS**

Concrete headwalls are required for all CPEP, HDPP and PVC culverts and pipe systems having exposed pipe ends. For detail, see Figure 7-3, Concrete End Protection.

## **7.6.3 GENERAL CULVERT DESIGN CRITERIA**

1. Maximum design headwater depth shall be 1.5 times the diameter of the culvert, with no saturation of roadbeds.
2. Minimum culvert diameters are as follows:
  - a. For cross culverts under public and private roadways - min. 18".
  - b. For all other roadway culverts, including driveway culverts - min. 12".
3. No bends shall be permitted in culvert pipes.
4. Minimum cover over culverts: 2' under primary roads, 1' under secondary roads and in all roadside applications and on private property.
5. Maximum culvert length: 300'.
6. Minimum separation from other utility pipes and conduits: 6" vertical (with bedding), 3' horizontal, unless otherwise specified by Department of Ecology (sanitary sewer crossings) or by the purveyor of the utility in question.
7. Pipe bedding and backfill shall conform to WSDOT specifications.
8. The entrances and outlets to all culverts 18" in diameter and larger shall be stabilized with quarry rock or other energy dissipation in order to minimize scouring of the channel. The recommendations within Table 7-4 Rock Protection at Outfalls should be followed with the exception that the inlet protection should extend upstream a minimum of 5' and should have a minimum height matching the design headwater elevation, and the outlet protection should have a minimum height of 1' above the design tailwater elevation, or 1' above the crown of the pipe, whichever is greater.

Figure 7-3 CONCRETE END PROTECTION



**NOTE:**  
REINFORCING STEEL SHALL HAVE 1 1/2 inch CLEAR COVER TO ALL CONCRETE SURFACES AND SHALL BE GRADE 40 OR GRADE 60.

**Concrete End Protection  
N.T.S.**

## **7.7 DESIGN CRITERIA FOR PIPE SYSTEMS**

Pipe systems, for the purposes of this manual, are systems comprising more than one run of pipe and including at least one junction type of structure such as a catch basin or manhole.

### **7.7.1 ACCEPTABLE PIPE MATERIAL**

The pipe materials listed in Table 7-5 are approved for use in pipe systems, subject to the limitations indicated. Pipe material specifications, joints and protective treatments shall be in accordance with WSDOT/APWA Standard Specifications.

### **7.7.2 PIPE ALIGNMENT**

Bends are not permitted in storm drainage pipes, except for the following applications:

1. Bends may be permitted with HDPP pipe in steep slope installations.
2. On private property, pipes smaller than 8" that are to be privately maintained may have bends.

For pipes 8" or larger in diameter, changes in direction must take place in a catch basin or manhole only. For pipes smaller than 8" in diameter, changes in direction may also take place in a cleanout.

### **7.7.3 CONNECTIONS TO PIPE SYSTEMS**

For all piped drainage systems, connections may only be made at a structure, such as a catch basin or manhole. Tees, wyes, saddles, or other types of connections to storm drainage pipes will not be permitted, EXCEPT that on private property, pipes smaller than 8" that are to be privately maintained may have tee and wye connections.

### **7.7.4 VERTICAL ALIGNMENT OF PIPES AT STRUCTURES**

Where minimum fall is proposed between inlet and outlet pipes in a catch basin or manhole, pipes must be aligned vertically by one of the following criteria, in order of preference:

1. Match pipe crowns.
2. Match 80% diameters of pipes.
3. Perform backwater analysis.

For catch basins having a sump with dead storage, drop manhole connections will not be required.

### **7.7.5 DOWNSIZING OF PIPES**

Pipes discharging from drainage structures may be of a smaller size than pipes entering that structure, provided that the smaller receiving pipe has sufficient flow capacity. The downsizing of pipes in such a manner is to be considered an obstruction having potential backwater effects. Such downsizing of pipes will only be permitted when the engineer has demonstrated, using backwater calculations, that a minimum 1.0' of freeboard will be maintained in all upstream structures and/or upstream channels.

### **7.7.6 GENERAL PIPE CRITERIA**

1. Minimum pipe cover: 2' under primary roads, 1' under secondary roads and on private property.
2. Minimum velocity: 3 fps unless otherwise approved by the Director as a Technical Deviation.
3. Maximum velocity: 30 fps, except that there is no maximum velocity requirement for ductile iron pipe or butt welded HDPP.
4. Minimum pipe diameter: 12" in right-of-way (8" may be permitted for street crossings if shallow gradients or utility conflicts exist); 8" is permitted for privately maintained primary conveyance lines; no minimum diameter is specified for privately maintained secondary roof and yard drain systems.
5. Maximum pipe length between structures: 300'.
6. Minimum separation from other utility pipes and conduits: 6" vertical (with bedding), 3' horizontal, unless otherwise specified by Department of Ecology (sanitary sewer crossings) or by the purveyor of the utility in question.
7. Debris barriers as shown in Figure 5-9 shall be installed at all inlets where an open channel discharges to a piped drainage system. Additionally, debris barriers are required at all outlets of piped systems where the pipe is 18" in diameter or larger and catch basins with sumps are located upstream of the outlet. This additional requirement is to deter small children from crawling up the pipe where they might fall into a catch basin full of water.
8. All pipe lengths and slopes shown on construction plans shall be based on measurements from center of structure to center of structure.
9. Pipe trench backfill: Bedding and backfill shall conform to WSDOT specifications.

### **7.7.7 STEEP SLOPE INSTALLATION**

Pipe systems located on slopes of 10% or greater declivity may require special design consideration for pipe anchoring and alternate pipe materials. The King County Surface Water Design Manual contains specific recommendations on maximum pipe slopes, maximum velocities and pipe anchoring. It is the responsibility of the project engineer to incorporate any necessary design measures required to locate pipe systems on slopes

### **7.7.8 PRIVATE SECONDARY DRAINAGE SYSTEMS**

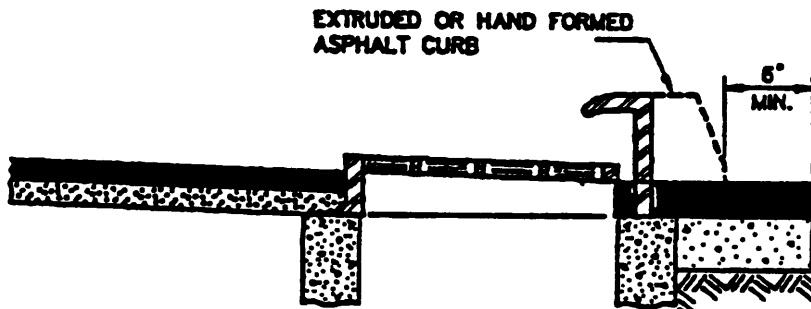
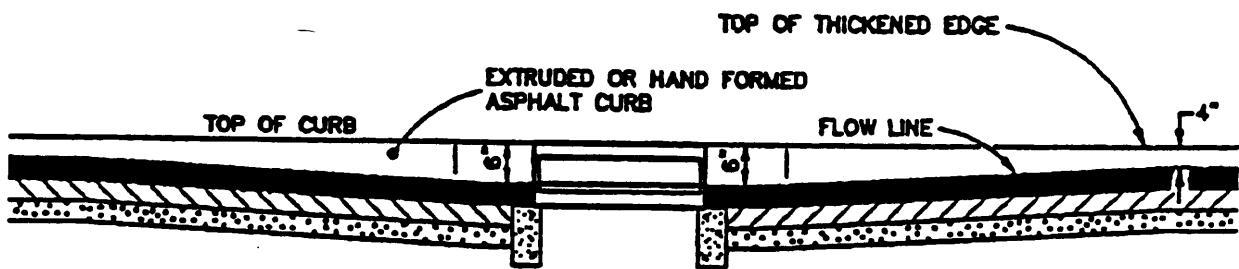
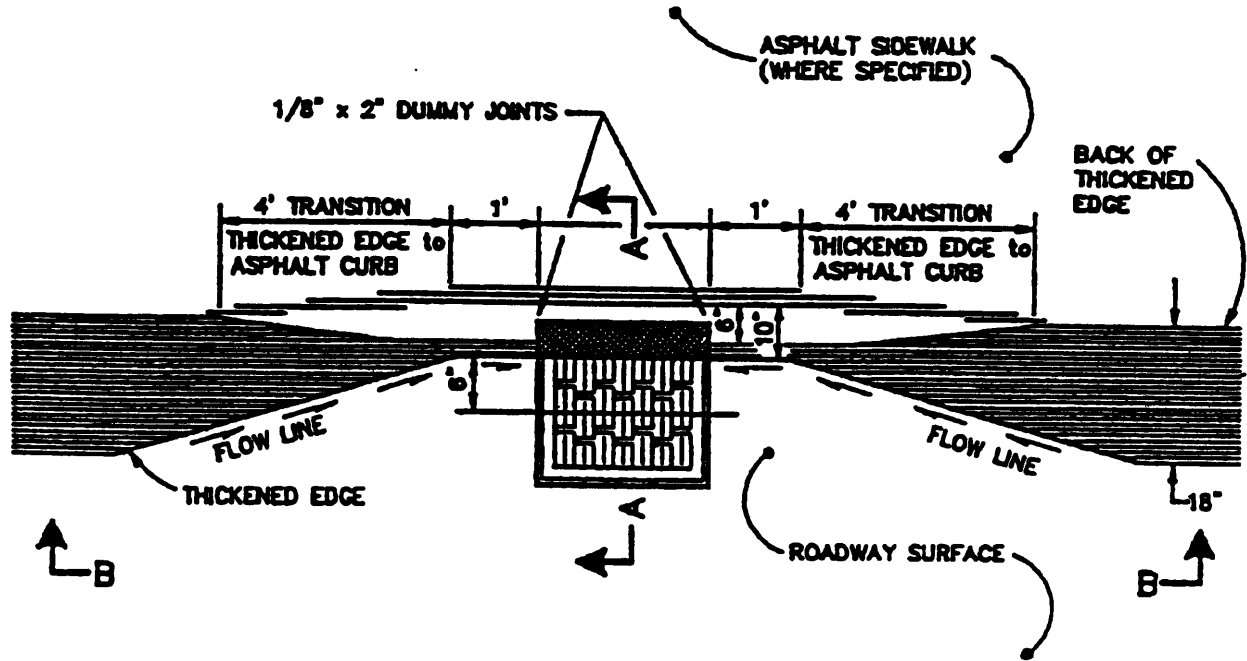
Stormwater will not be permitted to discharge directly onto the surface of any county road. For example, drainage from downspouts, roofs or subsurface drains will not be permitted to discharge into roadside gutters through openings in curbs. Also, concentrated drainage will not be permitted to discharge so as to flow across sidewalks or over curbs.

For single family residential lots, roof and downspout drainage must be directed to a lot drainage stubout or to an individual downspout infiltration system, with the following exception: splash blocks will be permitted, provided that drainage from downspouts has been designed to sheet flow through a minimum 50' of vegetation prior to discharge to adjacent properties. This exception does not waive the requirement of the design engineer to account for the developed runoff from the residential lot during the design of the stormwater facilities for the development.

## **7.8 DESIGN CRITERIA FOR INLET STRUCTURES**

1. In public right-of-way, structures for introducing stormwater into piped drainage systems must conform to the latest edition of WSDOT/APWA standards. Inlets without sumps for sediment containment are not permitted in public right-of-way.
2. The maximum depth of Type 1 and 1L catch basins is 5', measured from top of grate to invert of lowest pipe. Ladders must be provided in all Type 2 catch basins and manholes having a depth greater than 5'.
3. Thru-curb inlets are required on all catch basins located at roadway sags and in low points of cul-de-sacs. See Figure 7-4 for specifications regarding installation of thru-curb inlets in asphalt-thickened edge pavement.

Figure 7-4 THRU-CURB INLET DETAIL



Through-Curb Inlet with Thickened Edge  
N.T.S.



4. Vaned grates are required for all catch basin inlets located on roadway grades steeper than 6%.
5. The following maximum inlet spacings are recommended: (1) for roadway slopes less than 1%, maximum gutter flow distance should not exceed 150'; (2) roadway slopes from 1% to 3%, maximum gutter flow not to exceed 200'; (3) roadway slopes greater than 3%, maximum gutter flow length of 300'.
6. The maximum design water surface elevation in inlet structures shall be 1 foot below the top of the structure.

## **7.9 DESIGN CRITERIA FOR OUTFALLS**

Outfalls are points where collected and concentrated stormwater runoff is discharged into an open drainage feature such as a ditch, channel, swale, stream, river, pond, lake or other open body of water.

All outfalls shall be designed, meeting the criteria summarized in Table 7-4 Rock Protection at Outfalls.

## **7.10 STORMWATER PUMPS**

Stormwater pumps will only be permitted as a Technical Deviation approved by the Director. Any stormwater pumps so permitted must, at a minimum, meet the following criteria:

1. The proposed pump system is not intended to circumvent other drainage requirements.
2. The proposed pump system is the only feasible alternative to flooding.
3. The pump system must provide storage for a minimum of 25% of the runoff volume from a 2-year, 24-hour storm event. An emergency backup power source may be required, at the discretion of the Director.
4. The pump system must include dual pumps with an external alarm system.
5. Pump systems serving commercial and/or multi-family developments and individual single-family building sites must be privately operated and maintained. Prior to final approval of the project served by such a pump system, an agreement establishing responsibility for payment of costs resulting from the operation and maintenance of the pump system must be approved by Kitsap County and must be legally recorded.

## **7.11 BRIDGES**

The design of all bridges shall conform to WSDOT standards and specifications and AASHTO standards. The hydraulic design of bridges shall conform to Department of Fish and Wildlife standards as well as with this Manual.

## CHAPTER 8

# OPERATION AND MAINTENANCE



# CHAPTER 8

## OPERATION AND MAINTENANCE

### CONTENTS

8.1	OPERATION AND MAINTENANCE MANUAL	8-1
8.2	OPERATION AND MAINTENANCE REQUIREMENTS	8-3
8.2.1	RESPONSIBILITY FOR MAINTENANCE	8-3
8.2.2	MAINTENANCE FREQUENCY	8-3
8.2.3	DISPOSAL OF WASTE FROM MAINTENANCE ACTIVITIES	8-3
8.2.4	CONTROL STRUCTURES AND CATCH BASINS	8-4
8.2.5	INFILTRATION BASINS	8-4
8.2.6	INFILTRATION TRENCHES AND ROOF DOWNSPOUT INFILTRATION TRENCHES	8-5
8.2.7	CONCRETE GRID AND MODULAR PAVEMENT	8-5
8.2.8	DETENTION PONDS, VAULTS AND TANKS	8-5
	GENERAL	8-5
	VEGETATION	8-5
	SEDIMENT	8-6
	ACCESS	8-6
	NUISANCE CONDITIONS	8-6
8.2.9	BIOFILTRATION SWALES AND FILTER STRIPS	8-7
8.2.10	OIL/WATER SEPARATORS	8-7
	APPENDIX 8A - KITSAP COUNTY MAINTENANCE GUIDELINES	8A-1



# **OPERATION AND MAINTENANCE**

For stormwater quantity and quality control facilities to achieve their intended results, proper operation and timely maintenance are essential.

For most developments other than single-family residential, the permanent responsibility for operation and maintenance of stormwater facilities rests with the property owner. In addition, for single-family developments, the property owner/developer must temporarily bear this responsibility for a period of time following the completion of construction.

## **8.1 OPERATION AND MAINTENANCE MANUAL**

Upon completion of construction, and when "as-built" construction plans are submitted to Kitsap County, an Operation and Maintenance (O & M) Manual shall be submitted to the County for all proposed stormwater quantity and quality control facilities that are to be privately maintained or that have special non-standard features. The O & M Manual shall be prepared by a professional engineer. This manual should be brief and simply written so it can be effectively followed by those persons who will be responsible for operating and maintaining the facilities.

The following basic outline should be followed in the preparation of the Operation and Maintenance Manual:

1. **General Information:**
  - a. **Purpose of O & M Manual (briefly provide an introduction to the O & M Manual and a general statement on the overall purpose of operation and maintenance of the facility).**
  - b. **Location and Access to Facility (name of stream/tributary/lake, etc., that facility discharges to; nearest city/town; traveling directions to facility, including location of maintenance access roads). Include a vicinity map.**
  - c. **Purpose of Facility (e.g. peak rate runoff control, water quality, etc.).**
  - d. **General Description of Facility (e.g. detention pond, biofiltration swale, etc.).**
  - e. **Ownership (name, address and telephone number of owner of facility).**
  - f. **Project History (development for which facility was constructed, date of construction, original project engineer and contractor, any significant modifications that have taken place during the life of the facility).**





- b. Periodic Inspection (a periodic inspection is a more detailed inspection, during which all features and equipment at the facility are evaluated at regularly scheduled intervals.). A checklist should be provided to ensure that all critical features are examined.
- c. Inspection Report Form (a simple form, to be completed by the persons performing the periodic inspection, reporting the date of inspection, person performing inspection, findings, inspection checklist).

## **8.2 OPERATION AND MAINTENANCE REQUIREMENTS**

The following minimum requirements for operation and maintenance of stormwater facilities shall be incorporated into the Operation and Maintenance Manual:

### **8.2.1 RESPONSIBILITY FOR MAINTENANCE**

Property owners are responsible for the maintenance, operation or repair of stormwater drainage systems and BMPs. Property owners shall maintain, operate and repair these facilities in compliance with the requirements of the Stormwater Management Ordinance and with the requirements of this Manual.

### **8.2.2 MAINTENANCE FREQUENCY**

Stormwater facilities shall be inspected and maintained routinely and cleared of debris, sediment and vegetation when the functioning and/or design capacity of the facility is affected. Where lack of maintenance is causing or contributing to a water quality problem, immediate action shall be taken to correct the problem.

### **8.2.3 DISPOSAL OF WASTE FROM MAINTENANCE ACTIVITIES**

Disposal of waste from maintenance activities shall be conducted in accordance with the minimum Functional Standards for Solid Waste Handling, Chapter 173-304 WAC, guidelines for disposal of waste materials from stormwater maintenance activities, and where appropriate, the Dangerous Waste Regulations, Chapter 173-303 WAC. In addition, the D.O.E. "Technical Manual" addresses disposal procedures.

## 8.2.4 CONTROL STRUCTURES AND CATCH BASINS

Control structures and catch basins have a history of maintenance-related problems and it is imperative that a good maintenance program be established for their proper functioning. A typical problem is that sediment builds up inside the structure, blocking or restricting flow to the outlet. To prevent this problem, these structures should be routinely cleaned out. Regular inspections of control structures should be conducted to detect the need for non-routine cleanout, especially if construction or land-disturbing activities are occurring in the contributing drainage area.

Maintenance standards for control structures are contained in Appendix 8A.

## 8.2.5 INFILTRATION BASINS

**Inspection Schedule:** When infiltration basins are first placed into use, they should be inspected on a monthly basis, and more frequently if a large storm occurs in between scheduled inspections. During the period of October 1 through March 31, inspections shall be conducted monthly. Thereafter, once it is determined that the basin is functioning in a satisfactory manner and that there are no potential sediment problems, inspection can be reduced to a semi-annual basis with additional inspections following the occurrence of a large storm. This inspection shall include investigation for potential sources of contamination.

**Sediment Control:** Grass bottoms in infiltration basins seldom need replacement since grass serves as a good filter material. If silty water is allowed to trickle through the turf, most of the suspended material is strained out within a few yards of surface travel. Well established turf on a basin floor will grow through sediment deposits forming a porous surface and preventing the formation of an impenetrable layer. Grass planted on basin side slopes will also prevent erosion.

**Vegetation Maintenance:** Maintenance of vegetation established on the basin floor and side slopes is necessary in order to promote dense vegetation with extensive root growth. This enhances infiltration, prevents erosion and consequent sedimentation, and prevents invasive weed growth. Bare spots are to be immediately stabilized and revegetated.

The use of low-growing, stoloniferous grasses will permit long intervals between mowings. Mowing twice a year is generally satisfactory. Fertilizers should be applied only as necessary and in limited amounts to avoid contributing to pollution problems, including ground water pollution. Consult the local Conservation District for appropriate fertilizer types and application rates.

## **8.2.6 INFILTRATION TRENCHES AND ROOF DOWNSPOUT INFILTRATION TRENCHES**

**Inspection Schedule:** The observation well should be monitored periodically. For the first year after completion of construction, the well should be monitored after every large storm (>1 inch in 24 hours), and during the period from October 1 through March 31, inspections should be conducted monthly. From April 1 through September 30, the facility should be monitored on a quarterly basis. Once the performance characteristics of the structure have been verified, the monitoring schedule can be reduced to an annual basis unless the performance data indicate that a more frequent schedule is required.

## **8.2.7 CONCRETE GRID AND MODULAR PAVEMENT**

Where turf is incorporated into concrete grid and modular pavement installations, normal turf maintenance such as watering, fertilizing and mowing, will be necessary. Mowing is seldom required in areas of frequent traffic. It is documented that the hard surfaces in these installations require very little maintenance. However, fertilizers, pesticides and other chemicals may have adverse effects on concrete products. The use of such chemicals should be restricted as much as possible.

## **8.2.8 DETENTION PONDS, VAULTS AND TANKS**

### **GENERAL**

Maintenance is of primary importance if detention ponds are to continue to function as originally designed. See Appendix 8A for specific maintenance requirements.

Debris removal in detention basins can be achieved through the use of trash racks or other screen devices.

### **VEGETATION**

In wet ponds, periodic removal of dead vegetation will be necessary. The frequency of removal has not been established. Since decomposing vegetation can release pollutants captured in the pond, especially nutrients, it may be necessary to harvest dead vegetation annually prior to the winter wet season. Otherwise, the decaying vegetation can export pollutants out of the pond and also can cause nuisance conditions to occur. If harvesting is to be done in the shallow marsh area, a written harvesting procedure shall be prepared by a qualified wetland specialist and will be submitted with the drainage design to Kitsap County.

It is permissible to temporarily drain wet ponds during late Spring (MAY) and Summer if there is sufficient concern regarding insect breeding. **However, it is imperative that vegetation in shallow marsh areas not die off during drawdown periods. Otherwise,**

**the pollutant removal effectiveness of the wetpond can be severely impacted. In addition, the decaying vegetation can create nuisance conditions. Unless the owner provides test results demonstrating the absence of pollution from the standing water, any standing water removed during the maintenance operation must be disposed of to a sanitary sewer at an approved discharge location. Residuals must be disposed of in accordance with current Bremerton-Kitsap County Health District requirement.**

### **SEDIMENT**

Maintenance of sediment forebays and attention to sediment accumulation within the ponds, vaults and tanks is extremely important. Sediment deposition should be continually monitored in the basin. Owners, operators, and maintenance authorities should be aware that significant concentrations of metals (e.g., lead, zinc, copper and cadmium) as well as some organics such as pesticides, may be expected to accumulate at the bottom of these treatment facilities. Testing of sediment, especially near points of inflow, should be conducted regularly to determine the leaching potential and level of accumulation of problem material before disposal. Any problem materials encountered in sediment material shall be disposed of in accordance with Bremerton-Kitsap County Health District requirements.

### **ACCESS**

Maintenance access must be provided at all times to detention storage facilities, infiltration basins, control structures, etc. Access roads must be maintained to provide access by heavy vehicles. Gravel surfaces must be maintained and repaired and vegetation removed which would otherwise restrict the 15' width of the road, the 40' minimum outside turning radius, or the turnaround areas. Fences and gates must be repaired as necessary to maintain security. Where no fence is provided, bollards must be installed at all times to restrict vehicle access. All signs shall be in place and readable. Any damage resulting from vandalism shall be repaired. All manhole and catch basin lids shall be in place and locked (where locks are provided). Refer to Chapter 5, Stormwater Quantity Control Facilities, for design requirements for access facilities.

### **NUISANCE CONDITIONS**

The presence of wet ponds in established urban areas is perceived by many people to be undesirable. They are often thought of as mud holes where mosquitoes and other insects breed.

If the wet pond has a shallow marsh established, the pond can become a welcomed addition to an urban community. Constructed fresh water marshes can provide miniature wildlife refuges, and while insect populations are increased, insect predators also increase, often reducing the problem to a tolerable level.

### **8.2.9 BIOFILTRATION SWALES AND FILTER STRIPS**

Groomed biofilters planted in grasses must be mowed regularly during the summer to promote growth and pollutant uptake. Fertilizing and watering of biofilters may also be required. Be sure not to cut below the design flow depth (**maintenance personnel must be made aware of this requirement**). In addition:

1. Remove and dispose of cuttings promptly, so that no pollutants can enter receiving waters.
2. If the objective is prevention of nutrient transport, mow grasses or cut emergent wetland-type plants to a low height at the end of the growing season. For other pollution control objectives, let the plants stand at a height exceeding the design water depth by at least two inches at the end of the growing season.
3. Remove sediments during summer months when they 1) build up to 6 inches at any spot, 2) cover biofilter vegetation, or 3) interfere with biofilter operation. If the equipment leaves bare spots, re-seed them immediately.
4. Inspect biofilters at least monthly, especially after periods of heavy runoff. Remove sediments, fertilize, and re-seed as necessary. Be careful to avoid introducing fertilizer to receiving waters or ground water.
5. Clean curb cuts when soil and vegetation buildup interferes with flow introduction.
6. Provide educational information for residents near biofilters concerning the purpose and importance of keeping them free of lawn debris and litter.
7. Remove litter in order to keep biofilters attractive in appearance.
8. Roadside ditch cleaning should be based on an analysis of hydraulic necessity. Remove only the amount of sediment necessary to restore needed hydraulic capacity, leaving vegetative plant parts in place to the maximum extent possible.

### **8.2.10 OIL/WATER SEPARATORS**

Oil/water separators must be cleaned frequently to keep accumulated oil from escaping during storms. They must be cleaned by October 1 of each year to remove material that has accumulated during the dry season, and again after each significant storm. In addition:

1. The facility shall be inspected weekly by the owner.

2. Any oil absorbent pads shall be replaced by October 1 of each year and additionally as needed throughout the year.
3. The effluent shutoff valve is to be closed during cleaning operations.
4. Waste oil and residuals shall be disposed of in accordance with current Bremerton-Kitsap County Heath District requirements, as well as with State and Federal law.
5. Any standing water removed during the maintenance operation must be disposed of to a sanitary sewer at a discharge location approved by Kitsap County or the local Sewer District.
6. Any standing water removed shall be replaced with clean water to prevent oil from passing through the outlet weir or orifice.
7. Coalescing plates are to be removed and cleaned in a location that allows for collection and proper disposal of wash water. Cleaning of coalescing plates shall be in accordance with manufacturer's recommended procedures.