

# Table of Contents

---

Chapter 1 Introduction .....

Chapter 2 Design Criteria .....

Chapter 3 Design Elements .....

Chapter 4 Access and Intersections.....

Chapter 5 Traffic Control and Street Lighting .....

Chapter 6 Plan Preparation and Submittal .....

Chapter 7 Utility Installation/Work in County Right of Way .....

Chapter 8 Construction Control and Inspection .....

Chapter 9 Neighborhood Traffic Calming Program .....

Chapter 10 Permits and Standards for Use and Improvements to County Right of Way ....

## Figures

---

3.1 Typical Urban Roadway Section – Cement Concrete Barrier Curb, Gutter and Sidewalk

3.2 Typical Rural Roadway Section – Gravel Shoulders and Open Drainage .....

3.3 Typical Rural Roadway Section – Thickened Edge Curb .....

4.1 Standard Detail – “L” Intersection - Very Low Volume Local Roads .....

4.2 Standard Detail – Rural Residential/Major Approach .....

4.3 Standard Detail – Urban Residential Approach .....

4.4 Standard Detail – Urban Major Approach .....

4.5 Standard Detail – Urban Major Approach - Planter Strip .....

4.6 Standard Detail – Example Departure Sight Distance Diagram .....

5.1 Standard Detail – Type ST-2 Sign Support .....

5.2 Standard Detail – Typical Thermoplastic Crosswalk Pavement Markings .....

5.3 Standard Detail – Traffic Signal Phasing - Typical Four Leg Intersection .....

5.4 Standard Detail – Electrical Cabinet Foundation - Type 1 .....

5.5 Standard Detail – Electrical Cabinet Foundation - Type 2 .....

7.1 Standard Detail – Standard Trench and Pavement Restoration .....

8.1 Standard Detail – Cased and Surface Road Monuments .....

10.1 Standard Detail - Category 2 Right of Way Use Permit .....

Small Sized Trees (30' or Less).....

Medium Sized Trees (30' to 50') .....

## Tables

---

Table 3-1. Minimum Stopping Sight Distances .....

Table 3-2. Design Values for Arterial Roadway Features .....

Table 3-3. Design Values for Local Roadway Features.....

Table 3-4. Clear Zone Requirements.....

Table 4-1. Design Intersection Sight Distance .....

|

# KITSAP COUNTY ROAD STANDARDS-2007

---

## TABLE OF CONTENTS

### Chapter 1 – Introduction

1.1	Authority and Intent.....	1
1.2	Application.....	2
1.3	Associated Regulations and Specifications.....	2
1.4	Design Approval and Technical Deviation Procedure.....	4
1.5	Permits.....	5
1.6	Definitions.....	5

### Chapter 2 – Design Criteria

2.1	Functional Classifications.....	9
2.1.1	Arterial Functional Classification.....	10
2.1.1.1	Principal Arterial.....	10
2.1.1.2	Minor Arterials.....	11
2.1.1.3	Collector.....	11
2.1.2	Local Road Functional Classification.....	12
2.1.2.1	Local Sub-Collector.....	12
	Local Roads Minor.....	12
2.1.2.2	Local Road Cul-de-Sacs.....	12
2.1.2.3	Very Low Volume Local Road.....	12
2.2	Design Vehicle.....	12
2.3	Design Speed.....	13
2.4	Design Volumes.....	14
2.5	Stormwater Management.....	15
2.6	Requirements for On-Street Parking.....	15

## Chapter 3—Design Elements

3.1	Vertical Alignment.....	16
3.2	Sight Distance.....	17
3.2.1	Stopping Sight Distance.....	17
3.3	Grade.....	19
3.4	Horizontal Alignment.....	20
3.5	Right of way.....	23
3.6	Pavement.....	24
3.6.1	Road Widening / Adding Traveled Way To Existing Roads.....	24
3.7	Roadway Features.....	25
3.7.1	Cul de sacs.....	26
3.7.2	Two-Way Single Lane Roads.....	27
3.7.3	Non-Motorized Facilities.....	28
3.7.3.1	Sidewalks.....	28
3.7.3.2	Bikeways.....	28
3.7.3.3	Bicycle Path.....	28
3.7.3.4	Bicycle Lane.....	29
3.8	Clear Zone and Roadside Features.....	29
3.8.1	Side Slopes.....	29
3.8.2	Mailboxes.....	29
3.8.3	Guardrail.....	30
3.8.4	Retaining Walls.....	32
3.8.5	Street Trees.....	32

## Chapter 4—Access and Intersections

4.1	Access Control.....	33
4.1.1	Intersection and Access Spacing.....	34
4.1.2	Access Spacing.....	34
4.2	Roadway Intersections.....	35
4.2.1	Angles.....	35
4.2.2	"L" Intersections.....	35
4.2.3	Corner Radii.....	35
4.2.4	Intersection Control.....	36
4.2.5	Geometrics.....	37
4.2.6	Medians.....	37

4.3	Road Approaches .....	37
4.3.1	Residential Road Approach .....	38
4.3.2	Major Road Approach .....	38
4.3.3	Construction Criteria .....	38
4.3.4	Temporary Road Approach .....	39
4.3.5	Failure to Construct Properly .....	39
4.3.6	Fees .....	39

## Chapter 5—Traffic Control and Lighting

5.1	Signs .....	40
5.1.1	Regulatory, Warning, and Guide Signs .....	40
5.1.2	County Road Name Signs .....	40
5.1.3	Private Road Name Signs .....	40
5.2	Delineation .....	40
5.3	Signals .....	42
5.3.1	Design Criteria .....	42
5.3.2	Design Guidelines .....	42
5.4	Illumination .....	44
5.4.1	Design Guidelines .....	44

## Chapter 6—Plan Preparation and Submittal

6.1	General Criteria .....	46
6.2	General Plan Formatting .....	46
6.2.1	Cover Sheet .....	46
6.2.2	Horizontal Plan .....	47
6.2.3	Profile Elements .....	47
6.2.4	Intersection Plan Details .....	48
6.2.5	Channelization and Signage Plan .....	48
6.2.6	Signal and Illumination Plan .....	49
6.3	Time Limitation of Approval .....	51
6.4	Submittal Procedure .....	51
6.5	Changes to Approved Plans .....	51

## Chapter 7—Utility Installation / Work In County Right of Way

7.1	Permits.....	52
7.1.1	Emergency Permits.....	52
7.2	Fees.....	52
7.3	Sureties, Liability Insurance and Indemnification.....	53
7.3.1	Surety Bond.....	53
7.3.2	Waiver of Bonding Requirements.....	53
7.3.3	Commercial Liability Insurance.....	53
7.3.4	Indemnification.....	53
7.4	General Installation Guidelines.....	54
7.5	Adjustment and Relocation of Existing Utilities.....	54
7.6	Underground Utility Installation.....	55
7.6.1	Cover and Separation.....	56
7.6.2	Casings.....	57
7.6.2.1	Materials.....	57
7.6.2.2	Marking.....	57
7.6.2.3	Identification.....	57
7.6.3	Existing Roadways.....	57
7.6.3.1	Utility Trenches Parallel To Road Alignment.....	57
7.6.3.2	Utility Trenches Transverse To Road Alignment.....	58
7.6.4	Untrenched Construction (Jacking, Augering or Tunneling).....	59
7.6.5	Testing.....	59
7.6.6	Individual Service Lines.....	60
7.7	Above Ground Utilities.....	60
7.7.1	Power and Communication Lines.....	61
7.8	Installations on Roadway Bridges and Structure.....	61
7.9	Miscellaneous Provisions.....	62
7.9.1	Preservation, Restoration, and Cleanup.....	62
7.9.2	Traffic Control and Public Safety.....	62
7.10	Final Utility Adjustment to Finish Grade.....	62
7.11	Final Cleanup and Restoration.....	62

## Chapter 8—Construction Control and Inspection

8.1	Basis for Control of the Work.....	64
8.2	Temporary Traffic Control.....	64
8.2.1	Interim Traffic Control.....	64
8.2.2	Temporary Road Closures and Detours.....	65
8.2.3	Haul Routes.....	66
8.2.4	Construction Safety Zone.....	66
8.3	Right of Way Construction Inspection.....	67
8.4	Penalties for Failure to Notify for Inspection.....	68
8.5	Embankment Construction Control in Developments.....	68
8.6	Asphalt Paving Control and Acceptance.....	69
8.7	Survey Control.....	70
8.8	Call Before You Dig.....	70

## Appendix A—Approved Street Trees

### List of Figures

- 3—1 Typical Urban Roadway Section
- 3—2 Typical Rural Roadway Section—Gravel Shoulders
- 3—3 Typical Rural Roadway Section—Thickened Edge Curb
- 4—1 Rural Residential / Major Approach—Gravel Shoulders
- 4—2 Urban Residential Approach—Curb, Gutter and Sidewalk
- 4—3 Urban Major Approach—Curb, Gutter and Sidewalk
- 4—4 Departure Sight Distance Detail
- 4—5 “L” Intersection - Very Low Volume Local Road
- 5—1 Traffic Signal Phasing Diagram
- 7—1 Standard Trench and Pavement Restoration Detail



## Chapter 1

---

# Introduction

## 1.1 Authority and Intent

Chapter 36.75 RCW requires that County roads be established, laid out, constructed, altered, repaired, improved, and maintained by the County or by private individuals or entities authorized to perform such work under an agreement with the County legislative authority. Such work and improvements shall be done in accordance with adopted County standards under the supervision and direction of the County Engineer.

These Kitsap County Road Standards have been authorized by the Kitsap County Board of Commissioners to govern the design and construction of publicly maintained roadways within existing County right-of-way or roadways on private property that are to be dedicated to Kitsap County for right-of-way.

These Standards were developed to provide minimum design requirements for the safety, welfare, and convenience of the traveling public. They are intended to assist, but not ~~to~~ substitute for, competent work by design professionals. It is expected that land surveyors, engineers, and architects will bring to each project ~~the~~ their best skills from their respective disciplines. Application of minimum requirements does not take the place of sound engineering practice. Project Engineers designing road improvements under these standards should take into account all available information and use professional judgment based on training and experience to make final design determinations. Acceptance of plans by the County does not relieve the proponent or engineer from responsibility for ensuring that the design, specifications, and construction comply with current engineering standards and applicable federal and state laws and codes.

These Standards are not intended to represent the legal standard by which the County's duty to the traveling public is ~~to be~~ measured. These Standards are ~~also~~ not intended to limit any reasonable innovative or creative effort that ~~could improve~~ improves quality or ~~reduces~~ reduces costs or potential environmental impacts. Any proposed departure from these Standards ~~will~~ shall be judged on the likelihood that it ~~will~~ shall

produce a compensatory or comparable result, in every way adequate for County road users and residents and without significant reduction in level of service, safety, or operational efficiency.

Kitsap County encourages the use of low impact development techniques ~~which conserve natural areas and that~~ minimize impervious surfaces, loss of native vegetation and runoff generation associated with development ~~impacts.~~ The County Engineer may support deviations from adopted standards when low impact development techniques are employed without risk to the traveling public, critical infrastructure, or maintenance operations.

These Standards are intended to encourage standardization of road design elements and to help meet the public safety needs of motorists, bicyclists, and pedestrians. They address safety, convenience, appearance, stormwater management, economical maintenance, and requirements for the installation of utilities within transportation rights of way.

**Shortened Designation:** ~~\_\_\_\_\_~~ These Kitsap County Road Standards ~~will~~shall be cited routinely in the text as the “Standards.”

## 1.2 Application

The Kitsap County Road Standards apply to all designed and newly constructed or reconstructed public roads, sidewalks and trails within ~~a~~ Kitsap County ~~right-rights~~ of-way or within private property to be dedicated to Kitsap County for right-of-way by any person, firm, corporation or other entity. ~~They do not apply to roads in existence prior to the adoption of these Standards.~~ The Standards are not intended to apply to general maintenance activities performed on roads ~~in existence prior to January 13, 2003, the original date of adoption, as long as the maintenance activities do not significantly alter the dimensions or function of the road.~~

Land development activity that ~~will~~shall impact the level of service, safety, or operational efficiency of existing roads or that is required by other County Code or ordinance to improve such roads, may be required to provide improvements in accordance with these Standards. The need for off-site improvements to existing County roads shall be based on an assessment of the potential impacts of the proposal.

These Standards apply to the design and construction of County roads both by Kitsap County and the private development community. These Standards are not intended to govern the construction of privately maintained roads that are located outside County rights-of-way. It is, however, recommended that designers of such roads adhere to these standards.

## 1.3 Associated Regulations and Specifications

All road plans submitted to the County for review and approval shall be consistent with these Standards and current or amended County standards and ordinances. ~~These include, but are not limited to:~~ and Kitsap County Code.

~~A. Kitsap County Code.~~

~~B. Kitsap County Code Title 12 Stormwater Drainage.~~

~~C. Kitsap County Comprehensive Plan, Transportation Section.~~

~~D. Kitsap County Land Use and Development Procedures.~~

~~E. Kitsap County Critical Areas Ordinance~~

~~F. Kitsap County Bicycle Facilities Plan.~~

~~G. Kitsap County Capital Facilities Plan.~~

Stormwater management requirements associated with road improvements shall comply with the requirements of the Kitsap County Code Title 12, as it now exists or is hereafter amended. This document does not establish or supersede any of the requirements established in the Kitsap County Code Title 12 Stormwater Drainage, or other pertinent regulatory requirements. The Project Engineer must observe all other applicable regulations and design standards.

The most current edition as amended of the following publications and manuals shall be applicable when specifically cited in the Standards or when required by state or federal funding authorities.

- ~~+~~ *Policy on Geometric Design of Highways and Streets, (Green Book) published by the American Association of State Highway and Transportation Officials (AASHTO).*
- ~~+~~ *Standard Specifications for Road, Bridge and Municipal Construction*, published by the Washington State Department of Transportation (WSDOT) and American Public Works Association (APWA).
- ~~+~~ *Standard Plans for Road, Bridge and Municipal Construction*, published by WSDOT.
- ~~+~~ *Design Manual*, published by WSDOT.
- ~~+~~ *Local Agency Guidelines*, published by WSDOT.
- ~~+~~ *Guidelines for Geometric Design of Very Low-Volume Local Roads (ADT less than or equal to 400)*, published by the American Association of State Highway and Transportation Officials (AASHTO).

~~A. *A Policy on Geometric Design of Highways and Streets*, published by the American Association of State Highway and Transportation Officials (AASHTO).~~

✚ *Roadside Design Guide*, published by AASHTO.

✚ *Manual on Uniform Traffic Control Devices*, ([MUTCD](#)), published by the U.S. Department of Transportation, Federal Highway Administration, as amended and approved by WSDOT.

✚ *Construction Manual*, published by WSDOT.

✚ *Guide for the Development of Bicycle Facilities*, adopted by AASHTO.

✚ *Guide for the Planning, Design, and Operation of Pedestrian Facilities*, AASHTO

✚ *Traffic Manual*, as published by WSDOT.

✚ *Highway Capacity Manual*, published by Transportation Research Board ~~(2000)~~

✚ *ITE Trip Generation Manual*, published by Institute of Transportation Engineers ~~(Latest addition)~~

✚ *Bridge Design Manual*, published by WSDOT.

## 1.4 Design Approval and Technical Deviation Procedure

It is the intent of these design standards to allow the design professional maximum latitude in the geometric design of roadways within the County while keeping within the realm of acceptable design practice. In order to provide this latitude, it is recognized that there is a certain amount of discretion inherent in implementing these standards. The County Engineer shall make the final determination of the adequacy of the design parameters and standards employed on a particular project.

In the event that representatives for a private development project disagree with a determination by the County Engineer, or wish to request a deviation from these Standards, they may do so by submitting to the County Engineer a Request For Technical Deviation. ~~The Request for Technical Deviation shall be in writing and state the nature of the request, why the deviation is necessary and identify any adverse impacts. The technical deviation shall include supporting calculations demonstrating how the request meets the intent of the Road Standards, references for resource materials pertinent to the request and other supporting documents. The request must also include an engineering analysis of the alternatives. The Request for Technical Deviation shall be signed and sealed by a professional engineer, and shall meet the following criteria:~~

The Request for Technical Deviation shall at a minimum:

- (1) Be in writing and state the nature of the request,
- (2) State why the deviation is necessary and identify any adverse impacts,
- (3) Include supporting drawings and calculations demonstrating how the request meets the intent of the Road Standards,
- (4) Reference resource materials pertinent to the request and other supporting documents,
- (5) Include an engineering analysis of the alternatives,
- (6) Be signed and sealed by a Washington State licensed professional engineer

The County Engineer may allow less requirements for non-engineering minor deviation requests.

The County Engineer shall evaluate the request for deviation on these criteria:

- (1) The technical deviation ~~will~~shall not otherwise result in non-compliance with the Road Standards Ordinance or any other applicable code;
- (2) The granting of the technical deviation ~~will~~shall not result in non-compliance with development conditions imposed upon a project by the Department of Community Development, the Hearing Examiner and/or Board of Commissioners;
- (3) The granting of the technical deviation ~~will~~shall produce a compensating or comparable result that is in the public interest, and;
- (4) The granting of the technical deviation ~~will~~shall meet the objectives of safety, function, appearance, environmental protection and maintainability based on sound engineering judgment.

Within twenty (20) calendar days of the receipt of the Request for Technical Deviation, the County Engineer shall, in writing, accept, deny, or accept with conditions the request. If the request is denied, the County Engineer shall state the reasons for the denial. An



aggrieved party may appeal any administrative interpretation or departmental ruling related to the Standards by following the process set forth in Kitsap County Code, Title 21.04, as it now exists or is hereafter amended.

## 1.5 Permits

No person, firm, partnership, association, joint venture, corporation, or other public or private legal entity shall conduct any construction activity within County right-of-way unless the work is in accordance with a valid "Permit to Perform Work in County Right-of-way Way". To obtain a permit, the applicant shall submit an application to the Department of Public Works. The application submittal shall include a copy of the ~~County approved~~ construction plans, meeting all applicable requirements.

A copy of each "Permit to Perform Work in County Right-of-way Way" shall be available for inspection at the construction site for the ~~term~~duration of the ~~permit~~work.

Other Permits. Approval and issuance of the permits prescribed in Chapter 10 Category 2 Right of Way Use Permit, does not constitute approval of other applicable permits or requirements that may be required by other County ordinances, state or federal laws. It shall be the responsibility of the applicant to obtain all other permits and approvals required by other county, state or federal laws. Examples of some additional permits that may be required include hydraulic project approval (HPA) by the Washington State Department of Fish and Wildlife, construction and industrial discharge permits administered by the Washington State Department of Ecology under the National Pollutant Discharge Elimination System (NPDES) program, access connection permits issued by the Washington State Department of Transportation, State Environmental Policy Act (SEPA) approval, Critical Areas, Grading, Building, Forest Practice, Site Development Activity Permit (SDAP), etc.

## 1.6 Fees

Fees required under this Ordinance and/or the permit Standards are as specified in the Kitsap County Development Permit Fee Schedule which is adopted by resolution.

## 1.7 Responsibility to Provide Roadway Improvements

1. Any land development which; will impact the service level, safety, or operational efficiency of roads serving such land development; or is required by other county code or ordinance to improve such roads, shall improve those roads in accordance with these Standards. Off-site roadway improvements shall be based on an assessment of the impacts of the proposed land development.
2. Any land development abutting existing or proposed roads shall improve the frontage of those roads in accordance with these standards.
3. For all existing structures with remodels greater than 50 percent of the assessed value of the structure in any three-year period}, then the road improvement standards apply to the entire site. Remodeling includes improvements to the interior, exterior or any combination of interior or exterior improvements to the site's structure(s) or other area(s) on-site.
4. If the development is within an area where the County has adopted by resolution a subarea plan, Complete Street Plan, and or other transportation planning study identifying higher standards, the County Engineer may require those standards.

## 1.8 Definitions

"

Where terms, phrases and words are not defined, they shall have their ordinary accepted meanings within the context in which they are used. Webster's Third New International Dictionary of the English Language, unabridged, 1993 edition, shall be considered as providing ordinarily accepted meanings.

"Applicant" shall mean any person, firm, partnership, association, joint venture, corporation, or other public or private legal entity that proposes to engage in any construction activities within County ~~right-rights~~ of-way.

"Approach" shall mean a connection providing private vehicular access to or from the County road system.

"Arterial Roads System" shall mean roads within Kitsap County that have been classified using the federally designated functional class system. This system is used by the federal government to distribute transportation funds to local agencies. Arterial roads are typically intended to provide mobility while controlling direct access. Examples of arterials are Silverdale Way (Principal Arterial), Mile Hill Drive (Minor Arterial), and Hood Canal Drive (Collector ~~Arterial~~).

**“Auxiliary Lane”** shall mean the portion of the roadway adjoining the traveled way for parking, speed change, truck climbing, turning or other purposes supplementary to through-traffic movement, but shall not mean shoulder.

**“Average Daily Traffic (ADT)”** shall mean the volume of traffic passing a point or segment of a road, in both directions, during a short period of time, divided by the number of days in the period ~~and factored to represent an estimate of traffic volume for an average day of the year.~~ When only periodic counts are taken, the ADT volume can be ~~estimated~~ converted to Annual Average Daily Traffic (AADT) by ~~adjusting the periodic counts according to such factors as the season, month, or day of the~~ applying monthly, day of week, axle factor, and growth factor.

**“Buildable Acreage”** ~~is considered~~ **Bioretention” (shall mean)** Engineered facilities that treat stormwater by passing it through a specified soil profile, and either retain or detain the treated stormwater for flow attenuation.

"

**"Bulb"** shall mean a round area for vehicle turnaround typically located at the end of a cul-de-sac.

**"Clear Zone"** shall mean ~~the total roadside border area, starting at the~~ unobstructed, traversable area provided beyond the edge of the ~~traveled through~~ way, ~~provided~~ for the safe recovery of errant vehicles. ~~This area may consist of a shoulder, a recoverable slope, a nonrecoverable slope, and/or a clear run-out area. The clear zone includes the shoulders, bike lanes, and auxiliary lanes, except those~~ we auxiliary lanes that function like through lanes.

**"County"** shall mean Kitsap County.

**"County Engineer"** shall mean the Kitsap County Road Engineer, having the authority specified in Chapter 11.22 of the Kitsap County Code and under RCW 36.75.050 and 36.80, or his/her assigned designee.

**"Critical Slope"** ~~shall mean a slope on which a driver of an errant vehicle is likely to overturn. Slopes steeper than 3H:1V are considered critical slopes.~~

**"Cul-de-sac"** shall mean a short loop road, or road having only one end open to traffic and the other temporarily or permanently terminated by a vehicle turnaround.

**"Department"** ~~means the Department of Public Works.~~

**"Design Hourly Volume (DHV)"** shall mean generally the 30<sup>th</sup> highest hourly volume of the future year chosen for design. On the average rural road or arterial, DHV is about 15 percent of ADT. For urban areas, DHV is usually between 8 to 12 percent of the ADT.

**"Design Speed"** shall mean a selected speed used to determine the various geometric design features of the roadway.

**"Developer"** shall mean any person, firm, partnership, association, joint venture, corporation or other public or private legal entity participating as owner, promoter, or sales agent in the planning, platting, development, promotion, sale or lease of lands that are subject to the provisions of these standards.

~~"Driveway" shall mean a connection providing private vehicular access to or from the County road system.~~

~~"Eyebrow" shall mean a partial bulb located adjacent to the serving road that provides access to lots.~~

**"Fire Code"** shall mean the Fire Code adopted by Kitsap County Board of Commissioners under Title 14 of the Kitsap County Code as it now exists or is hereafter amended.

"Green Street" shall mean a street that integrates LID drainage facilities to manage stormwater runoff within the public right-of-way.

~~"Improvements" means the design and construction of, but not limited to, roads, drainage facilities (i.e., storm drains, detention/retention ponds, bioswales, ditches, etc.), sidewalks, pedestrian trails, street lighting systems, utilities, and bridges.~~

"Intersection" shall mean the junction of two or more public roads.

~~"Green Street" shall mean a street that integrates LID drainage facilities to manage stormwater runoff within the public right of way.~~

"L Intersection" shall mean a two legged, right angled intersection. "L Intersections" only apply to Very Low Volume local roads.

**"Limited Areas of More Intensive Rural Development (LAMIRD)"** shall mean areas outside the urban growth area designated as existing rural residential communities or villages, areas of mixed use activity, isolated areas of small-scale commercial/industrial activity, and historic towns pursuant to RCW 36.70A.070(5)(d). Kitsap County LAMIRDs are identified in KCC 17.360.

~~"L Intersection" shall mean a two-legged, right angled intersection. "L Intersections" only apply to Very Low Volume Local roads.~~

"Local Roads" shall mean roads that are typically intended to provide connections to the arterial road system and provide direct access to properties. While arterial roads emphasize mobility, local roads typically provide relatively short trip distances and discourage higher speeds. The local road system is composed of Sub-collectors, Local Road Minors, Cul-de-sacs and Very Low Volume roads.

~~"Loop"/"Low impact development (LID)" shall mean a road of limited length forming a loop, having no other intersecting road, storm-water and functioning mainly as direct access to abutting properties. A loop may be designated for one-way or two-way traffic.~~

~~"Low Impact Development" shall mean a stormwater land use management strategy that emphasizes strives to mimic pre-disturbance hydrologic processes of infiltration, filtration, storage, evaporation and transpiration by emphasizing conservation and use of existing on-site natural site features, site planning, and distributed storm water management practices that are integrated into a project design. LID is also known as green stormwater infrastructure or green stormwater solutions. LID is the preferred term used by the County. with distributed, small-scale stormwater controls to more closely mimic natural hydrologic patterns in residential, commercial, and industrial settings.~~

~~" Net developable "Net developable area" shall mean the site area after subtracting all portions rights-of-the-property except way, critical areas and associated (including bald eagle habitat regulations) and their buffers, stormwater controls, recreational facilities, public facilities, community drainfields or other area-wide sanitary sewer facilities, and open space (KCC 17.110.507).~~

~~"Nonrecoverable Slope" shall mean a slope between 3H:1V and 4H:1V on which a driver of an errant vehicle will be unable to stop or return to into a project design. LID is also known as green storm water infrastructure or green storm water solutions. LID is the roadway; preferred term used by the county~~

"

~~"Pavement Width" shall mean the paved surface, including paved shoulder on shoulder-type roads, or paved surface between curb, thickened edge, or gutter flow line.~~

~~"Permeable Pavement" shall mean pervious concrete, porous asphalt, permeable pavers or other forms of pervious or porous paving material intended to allow passage of water through the pavement section. It often includes an aggregate base that provides structural support and acts as a stormwater reservoir.~~

"Private Road" shall mean a privately owned and maintained vehicular access provided by a tract, easement or other legal means, typically serving ~~five (5) or more~~ three or more dwelling units or potential dwelling units.

"Project Engineer" shall mean a qualified professional engineer licensed to practice in the State of Washington.

"Public Road" shall mean a County publicly owned facility providing vehicular access, including the roadway and all other improvements located within the County right-of-way.

~~"Recoverable Slope" shall mean a slope on which a driver of an errant vehicle can regain control of the vehicle. Slopes of 4H:1V or flatter are considered recoverable.~~

"Right-of-Way" shall mean all property in which the eCounty has any form of ownership, interest or title, and which is held for the purpose of public roads and associated features such as, ~~median~~medians, sidewalks, bicycle facilities, and public utilities. This definition applies regardless of whether or not any road exists thereon or whether or not it is used, improved, or maintained for public travel.

"Road" shall mean a facility providing public vehicular access including the roadway and all other improvements inside the right-of-way.

"

**"Road Approach"** shall mean a ~~connection providing private vehicular access to~~ lane or ~~from the County road system.~~ "set of lanes making up one leg of an intersection."

**"Road," "Street" and "Highway"** ~~will~~ shall be considered interchangeable terms for the purpose of these Standards."

**"Roadway"** shall mean the pavement width plus any paved or non-paved shoulders for vehicular use.

"

**"Rural Areas"** shall mean areas so designated in Kitsap County Comprehensive Plan, and as implemented through community plans and area zoning, characterized by long-term low density development.

**"Shoulder"** shall mean the paved or unpaved portion of the roadway outside the traveled way that is available for emergency parking or non-motorized use.

**"Traveled Way"** shall mean the part of the road made for vehicle travel excluding shoulders and parking.

**"Unmaintained Road,"** as used in this chapter, means a road within county right of way which is accessible to public travel but is not maintained by the County.

**"Unopened Right of Way"** means a County right of way existing by dedication, easement or deed, but for which no vehicular roadway is evident nor has been constructed by the county or other parties through an approved county permitting process.

**"Urban Areas"** shall mean areas so designated in Kitsap County Comprehensive Plan, and as implemented through community plans and area zoning, characterized by commercial/industrial and denser residential development.

**"Utility"** shall mean an entity providing public service such as gas, electric power, ~~telephone, telegraph~~ telecommunications, stormwater management, water, sewer, or cable television, whether or not such company is privately owned or owned by a governmental entity.



**“Very Low Volume Local Road”** shall mean a public or private roadway with an average daily traffic count of less than or equal to 400-vehicles.

## 1.9 Survey Monuments

Survey monuments within Kitsap County are essential to the precise location of all land divisions (parcels) and County right of way boundaries. The framework for actual physical reference points, known as monuments, has been previously established and must be preserved to secure ownership boundaries. Existing monuments consists of a system of known points that serve as the basis of reference for subsequent new and existing land subdivisions. Kitsap County intends to help the citizens protect both government and roadway monuments. Working within the county right of way requires all individuals or corporations performing permitted construction or maintenance work comply with RCW 58.09.130 and WAC 332-120 to ensure monument preservation. The law protects monuments which are critical to the protection of private property rights and public infrastructure. Preservation of these monuments must be perpetuated by a Licensed Professional Land Surveyor registered in the State of Washington.

# Design Criteria

Project Engineers designing road improvements shall take into account the road's functional class, design vehicles, design speed, design volumes, stormwater management and on-street parking requirements to make final design determinations. Roadway alignments should be laid out to minimize impervious surface areas, preserve native vegetation and trees, and incorporate LID stormwater management practices where feasible.

## 2.1 Functional Classifications

The first step in the design process is to identify the functional classification of the roadway. A description of the existing and projected adjacent land uses ~~must~~shall accompany the proposal for functional classification of new facilities. This description should answer questions such as:

(1) Is the primary function ~~movement~~mobility or access?

(2) Is the roadway in an urban or rural environment?

(3) Are schools nearby?

(4) What is the expected pedestrian and bicycle activity?

~~(+)~~(5) Will the roadway serve an industrial or commercial site?

Roads are most effectively classified by their function, according to the character of service they are intended to provide. The primary functions of roads are to provide for mobility and access, and the degree to which these functions are provided is considered an integral part of classifying roads. The functional classification system creates a hierarchy of classified roads.

For example, a freeway provides a high degree of mobility but very limited access, available only at interchanges, which could be spaced several miles apart. Higher vehicle speeds and volumes are typical on these types of facilities and are, in fact, desirable. On the other hand, a local road in a residential neighborhood provides a high degree of access by way of numerous driveways approaches to adjacent lots, and lower vehicle speeds and volumes are desired. Between these two extremes are the remainder of the roads, commonly called the arterial system, that ~~must~~ provide both mobility and access.

Roads are grouped into a number of different classifications for administrative, planning, and design purposes. For example, the classification system can be used for planning of new routes, improvements to existing roads, planning for area development and providing minimum design standards or criteria to encourage the use of the road as intended. The existing ~~County Arterial Road System~~county arterial road system has been classified using the federally designated functional class system. This system is used by the federal government as a means to distribute transportation funds to local organizations.

The main considerations when classifying roads into functional groups are the travel desires of the public, land service needs based on existing and expected land use, and the overall continuity of the system. A classification plan that fits the various classes of roads together into a logical pattern and assigns realistic improvement standards to each class will promote the highest overall level of service. Urban and rural areas have different characteristics as to density and types of land use. Consequently, the nature of road and

highway networks are fundamentally different in these areas. These Standards provide for a separate classification of urban and rural functional road systems. For purpose of these Standards, rural areas are the areas designated rural in the County's Comprehensive Plan. Likewise, urban areas are those designated urban in the same plan. In some cases an urban road section may be warranted in areas outside the urban area.

Kitsap County definitions for each functional classification are presented below. The Kitsap County Comprehensive Plan, Transportation Section includes transportation plans for modes other than passenger vehicles. These modal plans are intended to overlay onto the functional classification system. For example, the [Non-Motorized Facilities Plan](#) ~~bicycle facilities plan~~ overlays the functional classification system to identify roadways that should include bicycle facilities as a design element.

The functional classification system directly addresses all roads in unincorporated Kitsap County that are under the jurisdiction of Kitsap County. Determination of functional classification for new roads ~~will~~shall be made by the County Engineer. State highways under the jurisdiction of the Washington State Department of Transportation are all legally designated arterials (RCW 46.61.195). The functional classifications are defined below.

Limited Areas of More Intensive [Rural](#) Development (LAMIRDs) are unique areas lying outside of the Urban Growth Area. They are existing rural residential communities or villages, areas of mixed use activity, isolated areas of small-scale commercial/industrial activity and historic towns. Many of these zones have land use patterns that are urban in character. At the direction of the County Engineer, roadway projects within LAMIRDs may be required to provide an urban road section or other amenities that may be required by an adopted community plan.

## ~~2.1.1 Arterial~~ 2.1.1 **Federal** Functional Classifications

The ~~County Arterial~~[County arterial](#) road system is divided into three [federal](#) functional classifications, Principal Arterial, Minor Arterial, and Collector.

### 2.1.1.1 **Principal Arterials**

**2.1.1.1** Principal arterials provide a network of roads which can be identified as unusually significant to the area in which it lies in terms of the nature and composition of travel it serves. In urban areas, these facilities may be very limited in number and extent, and their importance may be primarily derived from the service provided to travel passing through the area. In urbanized areas, their importance also derives from service to rural-oriented traffic, but equally or even more important, from service for major travel movements within these urbanized areas.

Urban principal arterials serve the major centers of activity of metropolitan areas, the highest traffic volume corridors, and the longest trips. They carry a high proportion of the total urban area travel on a minimum of roadway mileage. Principal arterials carry the major portion of trips entering and leaving urban areas, as well as the majority of through movements

\_bypassing the central city. They also serve significant intra-area travel, such as between central business districts and outlying residential areas, between major inner city communities, or between major suburban centers. Frequently, principal arterials carry important intra-urban and inter-city bus routes. This network provides continuity both internally and for all rural arterials that intercept the urban boundary.

Rural principal arterials consist of a connected rural network of continuous routes. They provide the highest degree of mobility, serve major centers of activity, and are the highest traffic volume corridors between suburban centers and larger communities. They frequently carry important intra-urban and inter-city bus routes.

#### **2.1.1.2 Minor Arterials—**

**2.1.1.2** Minor arterials connect to and augment the principal arterial system, as well as connect to rural collector roads.

Urban minor arterials provide service for trips of moderate length at a somewhat lower level of mobility than principal arterials. They also distribute travel to smaller geographic areas. Urban minor arterials contain facilities that place more emphasis on land access. Such facilities may carry local bus routes and provide intra-community continuity but ideally do not penetrate identifiable neighborhoods.

Rural minor arterials provide service to corridors with trip length and travel density greater than those predominately served by rural collectors. They link cities and larger towns and form an integrated network providing intra-community continuity. A rural minor arterial is typically a continuous road with a direct, rather than meandering, alignment. Rural minor arterials are routes whose design should be expected to allow for relatively high overall travel speeds with minimum interference to through movement. They may carry local bus routes, but ideally do not penetrate identifiable neighborhoods.

#### **2.1.1.3 Collector-**

**2.1.1.3** Collectors distribute trips from principal and minor arterials to the ultimate destination and collect traffic from local roads and channel it into the principal and minor arterial system.

Urban collectors differ from principal and minor arterials in that they may penetrate residential neighborhoods and provide direct land access. In the central business district and in other areas of like development and traffic density, urban collectors may include the road grid, which forms a logical entity for traffic circulation.

Rural collectors serve intra-county travel corridors linking nearby cities or towns with routes of higher classification. They may penetrate residential neighborhoods, provide direct land access and distribute trips from the principal and minor arterials through the area to the ultimate destination.



## 2.1.2 Local Road Functional Classifications

**2.1.2** The local road system consists of local sub-collectors, ~~local road minor, local road cul-de-sacs~~ and ~~very low volume~~ local roads. The local road system emphasizes land access in lieu of mobility. Local roads provide direct access to abutting land and provide service for trips of relatively short distances. Local roads should be designed for a relatively uniform low volume of traffic upon full development; ~~particularly local road minor and local road cul-de-sacs. The system.~~ Local roads should be designed to discourage excessive speeds and should minimize the necessity for traffic control devices. Internal roads with direct lot access should be discontinuous so as to discourage through traffic.

### 2.1.2.1 Local Sub-Collector

**2.1.2.1** Local sub-collectors serve as primary access to a development from the adjacent road system, providing circulation within neighborhoods. They channel traffic to the collector system from the local road ~~minor~~ classification in residential neighborhoods. A local sub-collector usually serves one neighborhood or a combination of a few small developments, rather than interconnecting two or more larger neighborhoods. Abutting residences are oriented away from the local sub-collector and direct lot access is discouraged.

Local Sub-collectors serve residential single family, multiple dwelling developments, commercial business office, professional activities, and industrial development.

### 2.1.2.2 Local ~~Road Minor~~ Roads

**2.1.2.2** Local roads provide direct access from abutting land to local sub-collectors. They are typically an internal subdivision road providing circulation within the subdivision. A local road ~~minor~~ is designed so that it can never become a higher classification roadway.

~~**2.1.2.3—Local Road Cul-de-Sac** are roads which are permanent cul-de-sacs, or short loops, connecting to a Local Road Minor. Direct lot access is provided throughout the length of the road. A local road cul-de-sac is designed so that it can never become a road of a higher classification.~~

~~**2.1.2.4—Very Low Volume Local Road** are Local Road Minor or Cul-de-Sacs with an average daily traffic (ADT) of less than or equal to 400. They are typically low speed roads within subdivisions where direct lot access is provided. Specific design parameters, features and treatments such as low speed curves and “L Intersections” may be applicable to these roadways.~~

## ~~2.2~~ 2.2 Design Vehicle

Roadway design ~~must~~shall take into account the weight, dimensions, and operating characteristics of vehicles expected to travel on the roadway. The road's geometry ~~must~~shall accommodate the physical dimensions and turning radius of selected “design vehicles.” Critical features such as road radii at intersections and on curves are generally designed for the largest design vehicle likely to use the road

with considerable frequency, or a design vehicle with special characteristics that ~~must~~shall be taken into account. Design vehicles are grouped in the following general classes:

**Passenger cars:** Full-size, compacts, and subcompacts plus all light vehicles and light delivery trucks (vans and pickups).

**Trucks:** Single-unit trucks, truck tractor-semitrailer combinations, and trucks or truck tractors with semitrailers in combination with full trailers.

**Buses/recreational vehicles:** Single unit buses, articulated buses, school buses, motor homes, and passenger cars or motor homes pulling trailers or boats.

Vehicles selected as the design vehicle for a roadway generally have the largest physical dimensions and widest turning radius of all vehicles in their ~~class~~types. AASHTO's "A Policy on Geometric Design of Highways and Streets" defines standard characteristics for ~~19~~ design vehicles within the general vehicle ~~classes. From the AASHTO list, the types. The~~ following ~~vehicles have been selected as the~~ minimum design ~~vehicle~~vehicles are for each roadway functional classification ~~of Kitsap County roadway~~ (see the AASHTO document for definitions~~vehicle~~ turning paths and descriptions~~dimensions~~):

~~Principal Arterial ————— WB-50 (Intermediate Semi-trailer)~~

~~Minor Arterial ————— WB-40 (Intermediate Semi-trailer)~~

~~Collector ————— SU (Single Unit Truck)~~

~~Local Sub-Collector ————— SU (Single Unit Truck)~~

~~Local Road Minor ————— SU (Single Unit Truck)~~

~~Local Road Cul-de-sac ————— SU (Single Unit Truck)~~

Principal Arterial                      WB-40 (Intermediate Semi-trailer)

Minor Arterial                        WB-40 (Intermediate Semi-trailer)

Collector                                SU-40 (Single Unit Truck)

Local Sub-Collector      SU-30 (Single Unit Truck)

Local Road              SU-30 (Single Unit Truck)

The project engineer ~~must insure~~shall ensure that design vehicles can negotiate a roadway without encroaching on the opposing lane or leaving the traveled way.

## ~~2.3~~ 2.3 Design Speed

Geometric design features of a road facility should be consistent with the design speed appropriate for the facility. ~~It should be noted, however, that the design speed does not necessarily represent the anticipated operating or posted speed.~~ The design speed for each road classification shall be as follows:

**Principal Arterial:** ~~Ten miles per hour over posted or proposed speed limit.~~ **Minor Arterial:** ~~\_\_\_\_\_ Ten miles per hour over posted or proposed speed limit.~~  
**Collector:** ~~\_\_\_\_\_ Ten miles per hour over posted or proposed speed limit.~~

~~Local Sub-Collector: Five miles per hour over posted or proposed speed limit.~~

~~Local Road Minor — Posted or proposed speed limit, minimum 25 mph.~~

~~& Cul-de-sac:~~

~~Very Low Volume Local Road: Posted or proposed speed limit, minimum 20 mph.~~

Principal Arterial, Minor Arterial, Collector: Posted or proposed speed limit.

Local Sub Collector: Posted or proposed speed limit.

Local Road: Posted or proposed speed limit, minimum 25 mph.

Very Low Volume Local Road: Posted or proposed speed limit, minimum 20 mph.

## 2.4 2.4 Design Volumes

The design volume is the traffic volume used in the design of a facility, representing the traffic expected to use the facility. Local road sub-collector, and local road ~~minor, and local road cul-de-sac~~ will~~shall~~ be designed using estimated ~~average daily traffic~~ Average Daily Traffic (ADT) projections. These projections shall be for a given time period (in whole days), greater than one day but less than one year, divided by the number of days in that time period. For roadways with functional classifications of principal arterial, minor arterial, or collector, the ~~design hourly volume~~ Design Hourly Volume (DHV) concept is used. This is the 30<sup>th</sup> highest hourly volume of the future year chosen for design. ~~On the average~~ For design purposes rural road or arterial, DHV ~~is about~~ shall be 15 percent of ADT. For urban areas, DHV is ~~usually between 8 to 12~~ 10 percent of the ADT. The County ~~will~~ shall provide these design volumes to the Project Engineer upon request.

~~The design year applicable to proposed projects is shown in Table 2.1.~~

For the purpose of these Standards, public roadways with an ~~average daily traffic (ADT)~~ of less than or equal to 400 are considered Very Low Volume Local Roads.

~~Table 2-1.~~ **5** Design Year

<del>Development Characteristic</del>	<del>Design Year</del>
<del>Small development (&lt;500 peak-hour trips)</del>	<del> <ul style="list-style-type: none"> <li>Anticipated opening year, assuming full build-out and occupancy</li> </ul> </del>
<del>Moderate single-phase development (500-1000 peak-hour trips)</del>	<del> <ul style="list-style-type: none"> <li>5 years after opening date.</li> </ul> </del>
<del>Large single-phase development (&gt;1000 peak-hour trips)</del>	<del> <ul style="list-style-type: none"> <li>5 years after full build-out and occupancy</li> <li>Adopted transportation plan horizon year</li> </ul> </del>
<del>Moderate or large multiple-phase development</del>	<del> <ul style="list-style-type: none"> <li>Anticipated year of complete build-out and occupancy</li> <li>Adopted transportation plan horizon year</li> </ul> </del>

All roadways shall be designed to traffic volumes at the time of full build-out of the development. A reasonable yearly growth rate shall be applied to background traffic. The county engineer shall determine the growth rate used in the calculation.

## **2.5** 2.6 Stormwater Management

All roadways ~~must~~shall have adequate crown or cross-slope, longitudinal grade for water to run off the roadway. All stormwater management elements of the roadway within the project boundaries shall be designed in accordance with the requirements of Kitsap County Code Title 12, Stormwater Drainage. Low impact development (LID) techniques ~~shall be encouraged~~are required to the ~~maximum~~ extent ~~practical~~feasible without causing flooding or erosion impacts. See the Kitsap County Stormwater Design Manual for the applicable stormwater management and LID requirements, and the Kitsap County Green Streets Plan for additional LID guidance.

## **2.6** 2.7 Requirements for On-Street Parking

~~In general, on-street parking promotes reduced travel speeds because it demands driver attention. Residential subdivisions with lot density greater than 4 dwelling units per buildable acre will, at a minimum, provide parallel on-street parking on one side of the roadway. Subdivisions with lot density greater than 7 dwelling units per buildable acre, will provide parallel on-street parking on both sides of the roadway.~~

In general, on-street parking reduces roadway capacity, reduces travel speeds, and can increase collision frequency. For these reasons, on-street parking on arterial roads is discouraged. In residential developments, a minimum of 0.5 spaces per unit shall be provided as on-street parking or in designated areas/lots outside the County right of way. The designated parking or areas/lots must be located so that each residential lot served is within 300 feet walking distance of the parking. On-street parking shall be parallel parking with a minimum of 8 feet in width by 20 feet in length for end spaces and 23 feet in length for intervening spaces. In no case shall parking reduce the road width to less than twenty feet of clear and unobstructed width, unless approved by the Kitsap County Fire Marshal. In urban growth areas (UGA) perpendicular or angled parking may be allowed on Local Roads Minor, Local Roads Cul-De-Sacs and Very Low Volume Local Roads. However, in such instances, increased safety measures such as a wider traveled way that does not impair sight distance may be required. Designated off-street parking located outside of the right of way, may be considered on a site specific basis.

All

- (1) on-street parking shall be in the public right of way.
- (2) If angled parking is requested on a collector or arterial road, the County will seek Transportation Secretary approval per RCW 46.61.575 as required. Angled parking may be allowed on local roads with approval of the County Engineer.
- (3) Preferred configuration for angled parking is back-in parking on bike routes.
- (4) Parking maneuver shall be designed so vehicle does not cross the road centerline.
- (5) Angled parking may require increased safety measures such as a wider traveled way that does not impair sight distance.
- (6) Angled parking stalls shall be designed to not encroach on the sidewalk.
- (7) Minimum parking dimensions for diagonal parking is 9 feet wide by 17 feet.

## Chapter 3

---

# Design Elements

### ~~3.1~~ 3.1 Vertical Alignment

The minimum lengths for vertical curves required to provide the minimum stopping sight distance are contained in ~~Tables 3-1 and 3-2, AASHTO.~~ Sag vertical curve design shall be based on the visibility available on a non-illuminated roadway. The automobile headlight beam distance should be at a minimum equal to the stopping sight distance. If illumination is provided, the length of the sag vertical curve can be designed for driver comfort as outlined in AASHTO. Crest vertical curve design shall be based on stopping sight distance for wet pavement. It should be emphasized that these lengths are minimum values based on design speed; longer curves are desired wherever practical. The following criteria for establishing lengths of vertical curves should always be considered.

- ~~1)(1) topography~~ Topography and stormwater management
- ~~2)(2) Passenger~~ Passenger comfort
- ~~travel~~



~~3)~~(3) Travel speeds

~~construction~~

~~4)~~(4) Construction costs

~~5)~~(5) General~~general~~ appearance

~~6)~~Illumination~~illumination~~

(6)

All grade changes greater than 1 percent shall be connected by a vertical curve. Grade breaks are not permitted at the beginning of vertical curvature, at the end of vertical tangency, nor in close proximity to another vertical curve or grade break. Minimum vertical curve lengths can be determined by multiplying the algebraic difference in tangent grades by the K values found in ~~Tables 3-1 and 3-2, AASHTO~~. The design of crest and sag vertical curves is related to design speed and is important for rural roads with higher driving speeds. The AASHTO document is the best source of information for the analysis of vertical and horizontal curvature.

Innovative techniques are encouraged to preserve habitat, retain trees, and reduce the creation of impervious area. Generally, roads should run perpendicular to contour lines when the land slopes at less than 10 percent, and parallel to contour lines when slopes exceed 10 percent.

## ~~3.2~~ 3.2 Sight Distance

The calculation of sight distance for stopping, decision, passing, and intersections is discussed in AASHTO's "A Policy on Geometric Design of Highways and Streets" and WSDOT's "Design Manual." Sight distance is the length of roadway visible to the driver. Passing sight distance is pertinent only on two lane, two way roadways. For paved roads with striped centerlines, appropriate ~~striping is necessary~~ passing and no passing zones are required to indicate to drivers where safe passing maneuvers are permitted. Intersections should be planned and located to provide as much sight distance as possible. At a minimum, excluding private ~~driveways, approaches~~ the intersection sight distance ~~must~~ shall provide sufficient sight distance for the driver on the minor roadway to ~~cross~~ enter or ~~turn left onto~~ cross the major roadway without requiring approaching traffic to reduce speed. (Chapter 4).

### 3.2.1 Stopping Sight Distance

Stopping Sight Distance is the sum of two distances: (1) brake reaction distance, which is the distance traversed by the vehicle from the instant the driver sights an object necessitating a stop to the instant the brakes are applied; and  
(2) braking distance, which is the distance needed to stop the vehicle from the instant brake application begins, as shown in Table 3-1.

Stopping sight distance shall be available throughout all horizontal and vertical curves. This distance is dependent on the height of the driver's eye above the road surface, the specified object height above the road surface, and the height and lateral position of sight obstructions within the driver's line of sight. Values are based on an object height of 2.0 feet and a driver's eye height of 3.5 feet. The effects of grade shall be accounted for through the use of a correction factor for grades steeper than 3 percent.

~~3.5 feet. The effects of grade must be accounted for through the use of a correction factor for grades steeper than 3 percent.~~

~~Sight distance shall be sufficient for vehicles on a major road to view an oncoming vehicle traveling at the speed limit and turning safely onto a major or minor road. Design analysis and detailed requirements for sight distance can be found in AASHTO.~~

In situations where the stopping sight distance ~~may be inadequate~~ is not clearly adequate, the County Engineer ~~will~~ shall require the Project Engineer to prepare a stopping sight distance diagram. The diagram shall include appropriate field measurements, and any proposed counter measures. The diagram and measurements shall be stamped and signed by the Project Engineer and submitted for review prior to the approval of the construction plans.

Table 3-1. Minimum Stopping Sight Distance for Vertical Curves Distances

Design Speed (mph)	Design Stopping Sight Distance (ft.) on level roads	Stopping Sight Distance (ft.) on grades							
		Down Grades			Up Grades				
		3-5%	6-8%	≥ 9%	3-5%	6-8%	≥ 9%		
20	115	7	17	116			120	126	109
25	155	12	26	158			165	173	147
30	200	19	37	205			215	227	200
35	250	29	49	257			271	287	237
40	305	44	64	315			333	354	289
45	360	64	79	378			400	427	344
50	425	84	96	446			474	507	405
60	570	151	136	598			638	686	538
		Downgrades			Upgrades				
		3%	6%	9%	3%	6%	9%		
20	115	116	120	126	109	107	116		
25	155	158	165	173	147	143	155		
30	200	205	215	227	200	184	200		
35	250	257	271	287	237	229	250		
<u>Design Speed (mph)</u>	<u>Design Stopping Site Distance (ft.) on level roads</u>	<u>Stopping Sight Distance (ft.) on grades</u>							
		Downgrades			Upgrades				
		3%	6%	9%	3%	6%	9%		

<u>40</u>	<u>305</u>	<u>315</u>	<u>333</u>	<u>354</u>		<u>289</u>	<u>278</u>	<u>2</u>
<u>45</u>	<u>360</u>	<u>378</u>	<u>400</u>	<u>427</u>		<u>344</u>	<u>331</u>	<u>3</u>
<u>50</u>	<u>425</u>	<u>446</u>	<u>474</u>	<u>507</u>		<u>405</u>	<u>388</u>	<u>3</u>

Note: Distances were calculated using friction factor for WET pavement.

[Source: A Policy on Geometric Design of Highways and Streets (~~Fifth~~Sixth Edition), AASHTO]

## 3-2.

**Minimum Stopping Distance Sight Distance for Crest Vertical and Horizontal Curves**

For Very Low Volume Local Roads

All locations for 0-100 vpd and "Lower risk" locations for 100-250 vpd (1) (vpd = vehicles per day)				"Higher risk" locations for 100-250 vpd and all locations for 250-400 vpd (2)		
		K, Value for Crest Curves				K, Value for Crest Curves
Design Speed (mph)	Stopping Sight Distance (ft)	Calculated	Design	Stopping Sight Distance (ft)	Calculated	Design
20	90	3.8	4	95	4.2	5
25	115	6.1	7	125	7.2	8
30	135	8.4	9	165	12.6	13
35	170	13.4	14	205	19.5	20
(1) "Lower risk" locations away from intersections, narrow bridges, railroad-highway grade crossings, sharp curves, and steep grades (2) "Higher risk" locations are locations near intersections, narrow bridges, or railroad-highway grade crossings, or in advance of sharp curves or steep downgrades (3) The rate of vertical curvature, K, is the length of curve (L) per percent algebraic difference in intersecting grades (A); i.e., $K = L/A$						

Source: Guidelines for Geometric Design of Very Low Volume Local Roads (2001)

**Sag Vertical Curves:** There are no special guidelines for the design of sag vertical curves on Very Low Volume Local Roads. Sag vertical curves should generally be designed in accordance with Table 3-1.

In some cases, stopping sight distances may not be long enough. Greater distances may be needed at locations where drivers must make complex or instantaneous decisions or where information is difficult to perceive. Refer to AASHTO's guidelines for decision sight distances at locations where additional margin of error would be prudent.

### **3.3 3.3 Grade**

Acceptable grade to assure proper emergency access, sight distance, and stormwater management is an important consideration for the design of a roadway. Tolerable maximum grades ~~will~~shall vary with road use. A steeper grade may be more acceptable on an urban residential road than on a rural road serving heavy trucks. Intersections on steep grades should be avoided whenever possible,

especially in areas with recurring snow and ice problems. Ease of access for emergency vehicles is also to be considered when establishing grades. Centerline slopes greater than 12% ~~requires~~require approval of the Fire ~~Marshall~~-Marshal. For rural projects, AASHTO's "A Policy on Geometric Design of Highways and Streets" includes tables of maximum grades related to design speed and terrain. The maximum centerline grade on any new or reconstructed road shall not exceed the following:

~~"A Policy on Geometric Design of Highways and Streets" includes tables of maximum grades related to design speed and terrain.~~

<u>Arterials</u>		<u>Local Road</u>	
<u>Principal</u>	<u>8%</u>	<u>Local Sub-collector</u>	<u>12%</u>
<u>Minor</u>	<u>8%</u>	<u>Local Road</u>	<u>12%</u>
<u>Collector</u>	<u>10%</u>	<u>Cul-de-sac Bulb</u>	<u>6%</u>
<u>Roundabout cross slope</u>	<u>6%</u>	<u>Roundabout cross slope</u>	<u>6%</u>

~~The maximum centerline grade on any new or reconstructed road shall not exceed the following:~~

<u>Arterials</u>		<u>Local Road</u>	
<u>Principal</u> .....	<u>8%</u>	<u>Local Sub collector</u> .....	<u>12%</u>
<u>Minor</u> .....	<u>8%</u>	<u>Local Road Minor</u> .....	<u>12%</u>
<u>Collector</u> .....	<u>10%</u>	<u>Local Road Cul de sac</u> .....	<u>12%</u>
		<u>Cul de sac Bulb</u> .....	<u>6%</u>

~~The maximum grade across a cul de sac bulb shall not exceed 6 percent.~~ With curbed roadways, (including asphalt tilt-up), longitudinal grades shouldshall be provided to facilitate surface stormwater management. ~~An appropriate~~The minimum grade is typically 0.5 percentalong a curb line shall be no less than 1 percent. Flat areas should be avoided to the maximum extent possible to preclude ponding. Particular attention should be given to the design of stormwater inlets and their spacing to keep the spread of water on the traveled way within ~~tolerable limits~~the limits required by the Kitsap County Stormwater Design Manual. Roadside channels and median swales frequently need grades steeper than the roadway profile for adequate stormwater management.

### **3.4** 3.4 Horizontal Alignment



Horizontal alignment consists of tangents and horizontal curves. Horizontal and vertical alignments are the two primary design control elements for the design of a roadway.

The road construction centerline shall match the right-of-way centerline unless otherwise approved by the County Engineer. Horizontal alignments should be laid out to minimize impervious surfaces, preserve native vegetation and trees, and incorporate LID facilities to the extent feasible. On Very Low Volume Local Roads, where design speeds are in the 20-25 mph range, short-radius curves and "L Intersections" may be tolerated and superelevation may not be necessary. Depending on design speed, curves with larger radii should be constructed with a normal crown section of 2 percent and curves with smaller radii should be superelevated in accordance with the appropriate superelevation rates found in AASHTO. Design speed, curvature, superelevation, and sight distance are based on formulas, experience, and good design practice. The alignment should be as direct as possible from the beginning to the end of the roadway and still blend with the topography, while preserving developed properties, community values, desired travel speeds, and environmental values. To maintain the desired speed, horizontal curves may be superelevated. Superelevation is the rotation or banking of the roadway cross-section to overcome forces that act on a vehicle traversing a curve.

The designer ~~must insure~~ shall ensure that the horizontal alignment accommodates the required design vehicles without encroaching on the opposing lane or leaving the roadway. Widening the travel lanes may be required to ensure that this requirement is met. Conventional turning templates or computer methods are routinely used for analysis of turning movements.

Tables 3-3, 3-4 and 3-5 show

The design superelevation rate for all county roads shall be  $e_{max} = 8\%$ . For low speed urban roads AASHTO table for minimum radius values of horizontal curves for given design speeds and functional classifications, radii and superelevation for low-speed urban streets should be used. Superelevations in urban areas should be kept to a maximum of 4%. A maximum of 8 percent superelevation may be used, upon approval of the County Engineer, for design of improvements to existing arterials, or to meet unique terrain and right-of-way conditions. Superelevation run-off lengths on arterials or local access roads shall be calculated in accordance with the WSDOT Design Manual, AASHTO. On Very Low Volume Local Roads, the use of short radius curves as shown in Table 3-5 may be appropriate, AASHTO Geometric Design of Very Low -Volume Local Roads is acceptable. When using the small curve radii shown in Table 3-5 for 20 mph design speed, it may will shall be necessary to provide a wider lane to accommodate the SU design vehicle. In cases where the average daily traffic is less than 400 vehicles a day, the developer may elect to use the higher volume criteria found in Table 3-4 and take advantage of the narrower lane widths.

Table 3-3. Minimum Horizontal Curvatures for Arterials

Arterials	Urban			Rural		
	Principal	Minor	Collector	Principal	Minor	Collector
Design Speed (mph) (See Section 2.3)	55	50	45	60	55	50
Horizontal Curvature, Normal Crown Section, Radius (Ft.)	1,552	1,191	900	2,000	1,552	1,191
Horizontal Curvature for 2 percent Superelevation, Radius (Ft.)	1,345	1,042	795	1,715	1,345	1,042
Horizontal Curvature for 4 percent Superelevation, Radius (Ft.)	1,190	926	711	1,500	1,190	926
Horizontal Curvature for 6 percent Superelevation, Radius (Ft.)	1,060	833	643	1,330	1,060	833
Horizontal Curvature for 8 percent (maximum allowable on arterials) Superelevation, Radius (Ft.) (requires approval of the Co. Engineer)	960	758	587	1,200	960	758

Source: A Policy on Geometric Design of Highways and Streets (Fifth Edition), AA HTO



Table 3-4. Minimum Horizontal Curves for Local Roads  
ADT > 400

Local Roads	Local Sub-Collector			Local Road Minor & Cul-de-sac	
		Minimum roadway width			Minimum roadway width
Design Speed (mph) (see Sec. 2.3)	40	Urban	Rural	25	Urban & Rural
Horizontal Curvature, Normal Crown Section, Radius (Ft.)	667	22-ft.	26-ft.	181	22-ft.
Horizontal Curvature for 2 percent Superelevation, Radius (Ft.)	593	22-ft.	26-ft.	167	22-ft.
Horizontal Curvature for 4 percent Superelevation, Radius (Ft.)	533	22-ft.	26-ft.	154	22-ft.
Horizontal Curvature for 6 percent Superelevation, Radius (Ft.)	485	22-ft.	26-ft.	144	22-ft.

Source: A Policy on Geometric Design of Highways and Streets (Fifth Edition), Low-Speed AASHTO

Table 3-5. Minimum Horizontal Curvature for Very Low Volume Local Roads  
 ADT ≤ 400 vehicle/day, Limited Heavy Vehicle Traffic

Local Roads	Local Road Minor & Cul-de-sac		Local Road Minor & Cul-de-sac	
		Minimum roadway width		Minimum roadway width at Curve
Design Speed (mph) (See Section 2.3)	25	Urban & Rural	20	Urban & Rural
Horizontal Curvature, Normal Crown Section, Radius (Ft.)	155	22-ft.	85	25-ft.
Horizontal Curvature for 2 percent Superelevation, Radius (Ft.)	140	22-ft.	75	25-ft.
Horizontal Curvature for 4 percent Superelevation, Radius (Ft.)	125	22-ft.	70	25-ft.
Horizontal Curvature for 6 percent Superelevation, Radius (Ft.)	115	22-ft.	65	25-ft.

Source: Guidelines for Geometric Design of Very Low Volume Local Roads (2001)

### 3.5 Right-of-way Way

The right-of-way width for any roadway shall be sufficient to accommodate all features of the road. Roadway features are defined as elements necessary for the construction, operation, and maintenance of the roadway. These include, but are not limited to, driving lanes, auxiliary lanes, bicycle lanes, shoulders and sidewalks, signs, ditches, LID facilities, slopes, and any utilities that may be expected to be placed within the right-of-way.

The minimum right-of-way width for a local road (~~and local~~ sub-collector, ~~minor, cul-de-sac~~) that ~~will~~shall ~~not~~ require any future widening, shall be 40 feet, provided that a non-exclusive utility easement is provided abutting the right-of-way on one or both sides so that the total

width of right-of-way and easement is no less than ~~50~~60 feet. Where cut or fill slopes exceed the minimum prescribed right-of-way, slope maintenance easements may be provided in lieu of providing additional right-of-way.

## 3.6 3.6 Pavement

Paving and sub-grade material for local roads shall be a minimum of ~~23~~-inch compacted depth of ~~Hot Mix asphalt, 2HMA, 2~~ 3-inch compacted depth of crushed surfacing top course, and 6-inch compacted depth of ~~gravel~~ crushed surfacing base ~~course~~. If there is evidence of instability in the sub-grade, the soil shall be sampled and tested sufficiently to establish a pavement design that ~~will support~~ supports the proposed construction. Remedial measures may include, a stronger paved section, strengthening the sub-grade by ~~adding or substituting~~ providing additional fractured aggregate, ~~asphalt treated base~~, installing geotextile material, more extensive stormwater management, or a combination of such measures.

Paving and sub-grade material for arterial roads shall be designed using currently accepted methodology. The design ~~must~~ shall consider the load bearing capacity of the soils and the traffic-carrying requirements of the roadway. Plans shall be accompanied by a pavement design based on soil strength parameters reflecting actual field tests and traffic loading analyses. The analysis shall consider the traffic volume and axle loading. The solution shall include the type and thickness of roadway materials and the recommended method of placement. The soils test report and the resulting pavement design ~~will~~ shall be subject to review and approval by the County Engineer. All concrete curb and gutter shall be constructed prior to paving. ~~Figures 3-1 through 3-3~~ Figures 3-1 through 3-3 show typical roadway pavement sections.

~~All new pavements in rural areas shall include a 30 degree safety edge along the outside of the paved roadway for roads with a posted speed of 35 mph or greater, and less than 2 feet paved shoulders. The safety edge is a simple shaping of the edge of the pavement to 30 degrees that eliminates the vertical drop-off, and allows motorists that leave the pavement to easily and smoothly return to the travelled way.~~

~~Permeable pavements shall be permitted in County rights of way on a case by case basis where soils, site conditions and traffic are compatible.~~

### 3.6.1 3.6.1 Road Widening ~~+/~~ Adding Traveled Way To Existing Roads ~~—~~

When an existing asphalt paved road is to be widened, a clean vertical edge on the existing pavement shall be provided for joining to the new asphalt. ~~The clean vertical edge shall be positioned to provide 3 feet of compactable area within the travel way. The compactable area is measured from the edge of curb, if present, or edge of travel lane.~~ After placement of the new pavement section, the joint shall be sealed with paving asphalt AR-4000W for tack coat, ~~the entire road pre-leveled and overlaid with a minimum~~

~~of one inch Hot Mix asphalt depending on the thickness of pavement lift throughout the widened area. The requirement for a pre-level course or overlay may be waived by the County Engineer based on the condition of the existing pavement and the extent of widening. If the joint falls in the wheel track a complete lane overlay shall be required.~~

The normal roadway crown slope for new construction is 2 percent. When widening of an existing road, a maximum of 4 percent crown slope is permitted. Grinding and/or overlaying as applicable ~~will~~shall be required if the cross slope exceeds 4 percent.

When an existing shoulder is required to become part of a proposed traveled way, a pavement evaluation shall be performed. This evaluation shall analyze the structural capacity and determine any need for improvement. Designs based on the evaluation are subject to review and approval by the County Engineer. The responsibility for any shoulder material thickness improvement shall be considered part of the requirement for roadway widening. The shoulder width, as a minimum, shall be replaced to the same width and material as existed before widening began.

Where widening of a roadway results in existing catch basins being located within the traveled way, a plan for adjustment and ~~+~~or relocation shall be provided.



## **3.7** 3.7 Roadway Features

~~Tables 3-6 and 3-7 present~~Chapter 42.5 Washington State Department of Transportation, Local Agency Guidelines (M 36-63.26) presents minimum roadway feature design values for each functional classification. ~~For the arterials, the design values vary with design hourly volume (DHV).~~

, as shown in Tables 3-2 and 3-3.

Table 3-~~6~~2. Design Values for Arterial Roadway Features

Arterials Design Standards	Principal Arterial			Minor Arterial				Collector				
	Curbed <sup>(4)</sup>	Shoulder		Curbed <sup>(4)</sup>	Shoulder			Curbed <sup>(4)</sup>	Shoulder			
	DHV All	DHV Below 200	DHV 200 and Over	DHV All	DHV Below 100	DHV 100 to 200	DHV 201 and Over	DHV 400 and Over	ADT 400 to 750	ADT 751 to 1000	DHV 100 to 200	DHV 201 and Over
Roadway Width <sup>(e)(1)(2)(7)(9)(1)</sup>	24 ft.	36 ft.	40 ft.	24 ft.	32 ft.	36 ft.	40 ft.	24 ft.	26 ft.	28 ft.	34 ft.	40 ft.
Lane Width:	12	12 ft.	12 ft.	12	12 ft.	12 ft.	12 ft.	12	10 ft.	10 ft.	11 ft.	12 ft.
(A) Exterior <sup>(e)(2)(7)</sup>	ft. <sup>(h)(11)</sup>			ft. <sup>(h)(11)</sup>				ft. <sup>(h)(11)</sup>				
(B) Interior Thru <sup>(e)(2)</sup>	11 ft.	11 ft.	11 ft.	11 ft.	11 ft.	11 ft.	11 ft.	11 ft.	10 ft.	10 ft.	11 ft.	11 ft.
(C) 2-Way Left Turn <sup>(e)(2)</sup>	11 ft.	11 ft.	11 ft.	11 ft.	11 ft.	11 ft.	11 ft.	11 ft.	10 ft.	10 ft.	11 ft.	11 ft.
(D) Exclusive Turn <sup>(e)(2)</sup>	11 ft.	11 ft.	11 ft.	11 ft.	11 ft.	11 ft.	11 ft.	11 ft.	10 ft.	10 ft.	11 ft.	11 ft.
(E) Parking (as required) <sup>(2)</sup>	10 ft. <sup>(e)(3)</sup>	=====	=====	10 ft. <sup>(e)(3)</sup>	=====	—	=====	10 ft. <sup>(e)</sup>	=====	—	—	—
(F) Bicycle Lane (as required) <sup>(4)</sup>	5 ft. AASHTO Guide for the Development of Bicycle Facilities, Kitsap County Non-motorized Plan, Chapter 3 of this Standard.											

Shoulder Width <sup>(e)-(f)</sup> <sub>(d)(7)(2)(2)</sub>	N/A	6 ft.	8 ft.	N/A	4 ft.	6 ft.	8 ft.	N/A	3 ft.	4 ft.	6 ft.	8 ft.
Sidewalk Width <u>(minimum)</u> <sup>(g)</sup>	56 ft.	=====	=====	56 ft.	=====	---	=====	56 ft.	=====	---	---	---

Ditch Slope (in-slope) Slopes steeper than 4H:1V should only be used when achieving a 4H:1V slope is impractical.

Clear Zone/Side Slopes

(a) For curbed, distance from face of curb to face of curb, ~~FR~~ or shouldered, distance from outside edge to outside edge of shoulder. ~~ensure lateral support.~~ ~~longer posts to~~  
~~edge of shoulder.~~ ~~Kitsap County Bicycle Facilities Plan.~~

(d) When guardrail is necessary, provide 2 feet of widening or ~~-----~~  
~~-----~~

(e) Width varies based on Design Hourly Volume (DHV) see ~~-----~~  
 required as a condition of Development

(f) Width varies ~~-----~~  
 longer posts to ~~-----~~

(b) AASHTO <sup>(10)</sup> Curbed section is appropriate for urban setting. ~~-----~~ ~~Section 42, WSDOT~~  
 Local Agency Guidelines. ~~-----~~ Approval.

(c) Industrial areas 8 feet to 10 feet and Residential areas 7 ~~-----~~ ~~-----~~  
 2 feet (14 feet minimum lane width) if feet to 10 feet, when the lane is not likely to become a ~~-----~~ ~~-----~~  
 not provided. ~~-----~~ (h) Provide additional ~~-----~~ bicycle lanes are ~~-----~~  
 traffic lane in the foreseeable future.

- (1) For curbed, distance from face of curb to face of curb, FR or shouldered, distance from paved edge to paved edge of shoulder.
  - (2) May be reduced to minimum allowed by AASHTO
  - (3) 8 feet may be acceptable when the lane is not likely to become a traffic lane in the foreseeable future.
- Curbed section is appropriate for urban setting Source: City and County Design Standards adopted in 1999, per RCW 35.78.030 and RCW 43.32.020

- (4)
- (5) Industrial areas 8 feet to 10 feet . Residential areas 7 feet to 10 feet
- (6) When guardrail is necessary, provide 2 feet of widening or longer posts to ensure lateral support
- (7) For roads with traffic volumes of less than 400 ADT, the low volume road and street standards may be used
- (8) Federal functional classification defined by WSDOT
- (9) For guidance for one-way streets, see AASHTO, and the current uniform fire code
- (10) When using AASHTO guidance for clear zone determinations, the designer should take into account all AASHTO materials relating to clear zone and project circumstances.
- (11) Provide additional 2 feet (13 feet minimum lane width) if bicycle lanes are not provided.

Note: Design Hourly volume (DHV). The DHV is generally the 30<sup>th</sup> highest hourly volume (30 DHV) of the future year chosen for design. On the average rural road or arterial, DHV is about 15 percent of ADT. For urban areas, DHV is usually between 8 to 12 percent of the ADT or AADT.

**Table 3-~~7~~3. Design Values for Local Roadway Features**

Local Roads	Urban			Rural		
	Local Sub-collector <u>Urban</u> (c)	Local Road <del>Minor Urban</del> (c)		Local Sub-collector <u>Rural</u>	Local Road <del>Minor Rural</del>	
Lane Width (a)(b) <del>(f)</del>	<del>11</del> <u>13</u> ft.	<del>11</del> <u>10</u> ft.		10 ft.	8 ft.	
<del>Low speed, Low</del>	<del>11</del> ft.	<del>11</del> ft.	<del>11</del> ft.	<del>10</del> ft.	<del>9.5</del>	<del>9.5</del>
Sidewalk, <del>both sides</del> or Shoulder Width	5 ft. (e)	5 ft. (e)		<del>3</del> <u>4</u> ft. (d)	3 ft. (d)	
<del>Clear Zone</del>	<del>1.5</del>	<del>1.5</del>	<del>1.5</del>	<del>10</del> ft.	<del>10</del> ft.	<del>10</del> ft.
Ditch Slope (in_slope)	N/A	N/A		2H:1V	2H:1V	

<p><del>(a)</del> For curbed, distance from face of curb to road centerline.</p> <p><del>For</del> <del>(e) For Curbed section is appropriate for urban setting.</del></p> <p><u>(a)</u> shouldered, distance from inside edge of shoulder to road <del>—— (d) When guardrail is necessary, provide 2 feet of widening or longer centerline. —— posts to ensure lateral support.</del></p> <p><u>(b)</u> Residential areas where on street parking is required, provide 7 <del>—— (e) When sidewalk is required as a condition of development 8</del> additional feet.</p> <p><del>(b)(c)</del> <u>Curbed section is appropriate for urban setting. —— approval.</u></p>	<p><u>(d) When guardrail is necessary, provide 2 feet of widening or longer posts to ensure lateral support.</u></p> <p><u>(e) When sidewalk is required as a condition of development approval.</u></p> <p><del>(e)(f)</del> <u>Additional width may be necessary at curves.</u></p>
--	---

### 3.7.1 Cul-de-sacs ~~——~~

**3.7.1** Whenever a cul-de-sac dead end road extends more than 150 feet measured from the centerline of the intersecting road to the farthest extent of surfaced traveled way, a widened "bulb" shall be constructed as follows:

- A. Minimum public right-of-way diameter across the bulb section shall be 100 feet. The right-of-way diameter may be reduced, provided utilities and necessary stormwater management are accommodated on permanent easements within the development.
- B. Minimum diameter of surfacing across the bulb shall be 80 feet of paving for a curb-type road and 80 feet total for a shoulder-type road, to include 74 feet of paving and 3-foot shoulders with compacted crushed surfacing material. Public roads in areas zoned CC Commercial or Industrial shall have a minimum roadway diameter of 100 feet. When on-street parking is required an additional 16 feet of paving is required.



C. Cul-de-sac Island: An optional feature for a cul-de-sac, an island, if provided, shall have a minimum diameter of 20 feet and shall be designed to accommodate the design vehicle. The island shall be grassed or landscaped and shall be maintained by the adjoining property owners or community association. Where on-street parking is required, parking adjacent to or in a cul-de-sac island is not permitted.

D. Where required on cul-de-sacs, sidewalks shall at a minimum be constructed on one side and on the bulb, terminating on a property line at or near half-way around the bulb.

~~E. Parking on medians, islands or sidewalks is prohibited.~~

~~F.~~ E. A cul-de-sac shall not be longer than 700 feet measured from the centerline of the intersecting road to the center of the bulb section. Proposed exceptions to this rule ~~will~~shall be considered by the County Fire Marshal based on pertinent traffic planning factors such as topography, sensitive areas, and existing development. The cul-de-sac length may extend to 1,000 feet if 50 or fewer potential lots are to be served and there is provision for emergency turnaround near mid-length.

~~G.~~ F. The County Engineer may require an off-road walkway or an emergency vehicle access to connect a cul-de-sac at its terminus with other roads, parks, schools, bus stops, or other pedestrian traffic generators.

~~H.~~ G. If a road temporarily terminates at a property boundary and is longer than 150 feet from the centerline of the intersecting road, a temporary bulb shall be constructed near the property boundary. The paved bulb shall be the appropriate diameter. Removal of the temporary cul-de-sac shall be the responsibility of the developer who extends the road.

~~I. The maximum cross-slope in a bulb shall not exceed 6 percent.~~

### 3.7.2 Two-Way Single-Lane Roads

**3.7.2** Provided that the established criteria for a technical deviation is accepted by the County Engineer, two-way single-lane roads may be used in physically constrained locations when the construction of a two lane road is not practical. Two-way single-lane roads may be constructed in areas serving residential plats but ~~will~~shall not be considered for business or commercial use. Two-way single-lane road cross sections are allowed only on local access roads where traffic volumes are less than 100 vehicles per day and the length is less than one half mile. Two-way single-lane roads are designed to operate at low speeds, typically no more than 25 mph.

Two-way single-lane roads shall be provided with a 20-foot unobstructed width paved to a minimum of 12 feet. Where the minimum unobstructed width cannot be met, a variance from the Fire Marshal is required. Design values of stopping sight distance for two-way single-lane roads should be twice the stopping sight distance for a comparable two-lane road. Turnouts shall be provided at a minimum of 500-foot intervals, or less if a traffic study indicates that more turnouts are necessary

after considering topography, horizontal and vertical alignment, and visibility. In some cases, particularly where increased sight distances are impractical, widening of the roadway at crests should be considered.

When a two-way single-lane road approaches a normal county road, the driving surface shall be a minimum of 20-feet in width with a minimum return radius of 35-feet. The full width driving surface shall be maintained for a minimum of 50-feet before tapering back to a two-way single lane road section at a taper of 1:25 for a symmetrical taper. All county maintained two-way single-lane roads shall be paved to full depth per county paving standards for local access roads.

### 3.7.3 Shoulders

All shoulders on arterials and collectors shall be paved full width. All local roads shall be compacted gravel or paved. Any roadway designated a bike route shall have a minimum of 4-foot paved shoulders. The paved portion of the shoulder shall be adjacent to the paved travel lane.

### 3.7.4 Curbs

All urban curbs shall be concrete construction, 6-inch vertical face with a minimum 12-inch gutter (see WSDOT Standard Plans, Cement Concrete Traffic Curb and Gutter). Rural asphalt thickened edge sections may be used to channel stormwater. Thickened edge sections will be in addition to the minimum shoulder width; 18-inch run with 4-inch rise (see Figure 3-3 ).

### 3.7.5 Non-Motorized Facilities—

**3.7.3** Kitsap County encourages a variety of mobility options supporting alternatives to automobile travel. ~~The basic concept of non-motorized facilities is that of a multi-linear system based on existing roadways, natural resource corridors, or other protected corridors and districts.~~ These facilities increase non-motorized transportation opportunities, improve the beauty and health of the

environment, and provide for outdoor recreation. Enhanced bicycle and walking facilities offer travel options for those who are unable to drive or choose not to drive for all or some trips.

### 3.7.5.1 Sidewalks

**3.7.3.1** Sidewalks are constructed of concrete and are raised and located adjacent to curbs or separated from the curb by a linear planting strip. ~~On local residential roads, the sidewalk width is typically~~ Planting strips shall be a minimum of 56 feet wide. On collector and arterial roads, the sidewalk width can vary ~~from 6 feet to 15 feet or more~~ depending on the location. Pedestrian facilities may be required as part of road improvements where there are anticipated or existing origins and destinations within acceptable pedestrian travel distances that ~~will~~ may generate trips. These include, but are not limited to; schools, parks, shopping areas, medical facilities, social services, housing, community and recreational centers, and transit and park-and-ride facilities. Where sidewalks are required, sidewalk and curb ramps shall meet the requirements of the Americans with Disabilities Act. Separate curb ramps shall be provided for each direction of permitted pedestrian travel.

### 3.7.5.2 Bikeways

**3.7.3.2** Bikeways are a generic term for any road, path, or way which is specifically designated for bicycle travel, regardless of whether such facilities are designated for exclusive use of bicycles or are to be shared with other transportation modes.

### ~~Bicycle~~ 3.7.5.3 Shared-use Path ~~(shared~~

**3.7.3.3** Shared use path ~~is a bikeway~~ physically separated from the motorized vehicular traffic by an open space or barrier and either within the highway right-of-way or within an independent right-of-way. Shared use paths may be utilized by pedestrians, skaters, wheelchair users, joggers, and other non-motorized users. ~~Bicycle paths are two-way facilities and are either bicycle-only or shared bicycle/pedestrian facilities.~~ The minimum width for a two-way combined bicycle and pedestrian facility is 10 feet paved. For areas of anticipated high volume use, ~~a 12-foot~~ wide is minimum. Sixty bicycles per hour is considered high volume. Twenty pedestrians per hour in peak hour conditions is also high

volume. ~~Bicycle paths for exclusive bicycle use should be a minimum of 8 feet wide for anticipated low volume, and 12 feet for high volume. If a bicycle path is one way, the minimum width allowed is 6 feet.~~

**3.7.5.4 Bicycle Lane**

**3.7.3.4** A bicycle lane is a portion of a roadway, which has been designated by striping, signing, and/or pavement markers for the preferential or exclusive use of bicycles. ~~Bicycle lanes are always one-way facilities that move in the same direction as motorized vehicles.~~ Bicycle lanes are for bicycles only, and should not be used by pedestrians. For curbed roadways, the minimum lane width is 5 feet from face of curb. Bicycle lanes along roadways without curbs ~~will~~shall maintain a minimum width of 4 feet. ~~For roadways with on-road parking, the minimum width is 5 feet, measured 9 feet from the face of curb, or 9 feet from the outside edge of where the vehicles are parking along the road.~~

**3.8 3.8 Clear Zone and Roadside Features**

The term “clear zone” is used to designate the unobstructed, ~~relatively flat-traversable~~ area beyond the edge of the traveled way provided for the recovery of errant vehicles. The intent is to provide ~~for arterials roadways with~~ as much clear, ~~traversable recovery zone~~ area as practical. The clear zone includes ~~any~~ shoulders ~~or, bike lanes, and~~ auxiliary lanes. ~~The Features that a vehicle might encounter when it leaves the roadway, and should be evaluated for mitigation include sideslopes, fixed objects, and water hazards. Mitigation measures include removal, redesign, relocate, reduce impact severity, shield, or delineate. Clear zone evaluation shall conform with AASHTO guidelines, and the clear zone values in Table 3-8 are~~ used to ~~judge the adequacy of the existing clear zone and to~~ provide a minimum target value for roadway design. ~~These values are not to be used as justification to compromise or take away from the existing clear zone. Clear zone requirements for local roads are shown on~~ applicable to new construction.

**Table 3-~~7~~. The 4. Clear Zone Requirements**

<u>Posted Speed</u>	<u>Design ADT</u>	<u>Fill Slopes (H:V)</u>			<u>Cut Slopes (H:V)</u>		
		<u>6 : 1 or flatter</u>	<u>5 : 1 to 4 : 1</u>	<u>3 : 1</u>	<u>3 : 1</u>	<u>4 : 1 to 5 : 1</u>	<u>6 : 1 or flatter</u>
<u>40 (mph)</u>	<u>Under 750</u>	<u>7-10</u>	<u>7-10</u>	<u>**</u>	<u>7-10</u>	<u>7-10</u>	<u>7-10</u>
	<u>750-1500</u>	<u>10-12</u>	<u>12-14</u>	<u>**</u>	<u>12-14</u>	<u>12-14</u>	<u>12-14</u>

or Less	<u>1500-6000</u>	<u>12-14</u>	<u>14-16</u>	<u>**</u>	<u>14-16</u>	<u>14-16</u>	<u>14-16</u>
	<u>Over 6000</u>	<u>14-16</u>	<u>16-18</u>	<u>**</u>	<u>16-18</u>	<u>16-18</u>	<u>16-18</u>
45-50 (mph)	<u>Under 750</u>	<u>10-12</u>	<u>12-14</u>	<u>**</u>	<u>8-10</u>	<u>8-10</u>	<u>10-12</u>
	<u>750-1500</u>	<u>14-16</u>	<u>16-20</u>	<u>**</u>	<u>10-12</u>	<u>12-14</u>	<u>14-16</u>
	<u>1500-6000</u>	<u>16-18</u>	<u>20-26</u>	<u>**</u>	<u>12-14</u>	<u>14-16</u>	<u>16-18</u>
	<u>Over 6000</u>	<u>20-22</u>	<u>24-28</u>	<u>**</u>	<u>14-16</u>	<u>18-20</u>	<u>20-22</u>

\* Where a site specific investigation indicates a high probability of continuing crashes, or such occurrences are indicated by crash history, the designer may provide clear zone distances ~~of~~ greater than shown in Table 3-8. Clear zones may be limited to 30 feet ~~from~~ for practicality and to provide a consistent roadway template if previous experience with similar projects or designs indicates satisfactory performance.

\*\* Since recovery is less likely on the unshielded, traversable 3H:1V slopes, fixed objects should not be present in the vicinity of the toe of these slopes. Recovery of high speed vehicles that encroach beyond the edge of shoulder may be expected to occur beyond the toe of slope. Determination of the width of the recovery area at the toe of slope should take into consideration right of way availability, environmental concerns, economic factors, safety needs, and crash histories. Also, the distance between the edge of the through traveled ~~way~~ lane and the beginning of the 3H:1V slope should influence the recovery area provided at the toe of slope.

Source: Roadside Design Guide (latest version 2011), AASHTO

Establishing clear zones based on Table 3-4 in urban areas with restricted environments may not be practical. Urban environments are characterized as having sidewalks, landscaping, transit shelters, poles or street furniture located adjacent to curbs. Roadways in urban environments typically have lower speeds and in some cases on-street parking. Designing a clear zone for a roadway in an urban restricted environment shall be based on guidance from AASHTO Roadside Design Guide.

### 3.8.1 Side Slopes—

**3.8.1** Side slopes on local roads shall be constructed no steeper than 2H:1V. Side slopes on arterials shall be no steeper than 3H:1V for cut slopes and 4H:1V for fill slopes. Steeper slopes may be approved by the County Engineer when accompanied with a geotechnical report by a qualified professional engineer showing that the steeper slopes ~~will~~ shall be stable.

Side slopes shall be stabilized by grass sod or seeding or by other planting or surfacing materials as required by the Kitsap County Code and Washington State erosion and stormwater control standards.

### **3.8.23.8.2 Mailboxes**

No mailbox or newspaper delivery box, hereinafter referred to as mailbox, ~~will~~shall be allowed to exist on Kitsap County right-of-way if it interferes with the safety of the traveling public or the function, maintenance, or operation of the County road system. The location and construction of mailboxes shall conform to the regulations of the U.S. Postal Service. In addition, the installation of all mailboxes located within the clear zone and on Kitsap County right-of-way shall meet the following requirements:

- A. The maximum size post allowable is 4-inches by 4-inches for a wooden post and 2-inches in diameter for a standard steel or aluminum pipe post. The post shall be embedded no more than 24-inches into the ground. A metal post shall not be fitted with an anchor plate, but it may have an anti-twist device that extends no more than 10-inches below the ground surface.



- B. Mailbox supports shall be separated a distance at least equal to three-fourths of their heights and preferably their full heights above ground.
- C. Multiple mailbox installations ~~must~~shall meet the same criteria as single mailbox installations.
- D. The Neighborhood Delivery and Collection Box Unit (NDCBU) is a specialized type of multiple mailbox installation that generally consists of a cluster of 8 to 16 locked boxes mounted on a pedestal or within a framework. NDCBU's are not allowed within the clear zone on Kitsap County ~~Right-right~~of-way, except on very low-volume local roads.
- ~~E.~~ E. Refer to AASHTO's Roadside Design Guide or Washington State Department of Transportation (WSDOT) Standard Plans for details of acceptable mailbox assemblies.

~~F. Proprietary mailboxes and support hardware will be allowed if accepted by the Federal Highway Administration (FHWA) for use as a National Cooperative Highway Research Program (NCHRP) Report 350 crash tested device.~~

A mailbox installation not conforming to these standards ~~will~~shall be considered an unauthorized encroachment into County ~~right-~~of-way. The owner of a problematic mailbox shall be notified in writing that their mailbox does not comply with Kitsap County standards. At the discretion of Kitsap County, based on an assessment of the hazard to the public, the owner of the mailbox shall be granted not less than 24 hours or more than 14 days to remove an unacceptable mailbox. After the specified period has expired, the unacceptable mailbox ~~will~~shall be removed by Kitsap County at the owner's expense.

### ~~3.8.3~~ — Guardrail

### 3.8.3 Traffic Barriers

#### Barrier

~~All roads that do not meet the minimum roadway clear zone and recovery area criteria, to include slopes, shall be required to install guardrail. An exception to this is when the installation of guardrail creates a greater hazard with the potential of redirecting errant vehicles into oncoming traffic.~~

Guardrail installations shall conform to WSDOT ~~Standard Plans,~~ WSDOT Design Manual and ~~LAG Manual.~~

Table 3-8. Clear Zone Standard Plans. Recommendations for Arterials barrier installations shall conform to AASHTO standards.

DESIGN SPEED	DESIGN ADT	FILL SLOPES (H:V)			CUT SLOPES (H:V)		
		6:1 or flatter	5:1 to 4:1	3:1	3:1	4:1 to 5:1	6:1 or flatter
45-50 MPH	Under 750	10-12 ft.	12-14 ft.	**	8-10 ft.	8-10 ft.	10-12 ft.
	750-1500	14-16 ft	16-20 ft	**	10-12 ft	12-14 ft	14-16 ft
	1500-6000	16-18 ft	20-26 ft	**	12-14 ft	14-16 ft	16-18 ft
	Over 6000	20-22 ft	24-28 ft	**	14-16 ft	18-20 ft	20-22 ft
55 MPH	Under 750	12-14 ft	14-18 ft	**	8-10 ft	10-12 ft	10-12 ft
	750-1500	16-18 ft	20-24 ft	**	10-12 ft	14-16 ft	16-18 ft
	1500-6000	20-22 ft	24-30 ft	**	14-16 ft	16-18 ft	20-22 ft
	Over 6000	22-24 ft	26-32 *	**	16-18 ft	20-22 ft	22-24 ft
60 MPH	Under 750	16-18 ft	20-24	**	10-12 ft	12-14 ft	14-16 ft
	750-1500	20-24 ft	26-32 *	**	12-14 ft	16-18 ft	20-22 ft
	1500-6000	26-30 ft	32-40 *	**	14-18 ft	18-22 ft	24-26 ft
	Over 6000	30-32 *	36-44 *	**	20-22 ft	24-26 ft	26-28 ft

\*—Where a site specific investigation indicates a high probability of continuing crashes, or such occurrences are indicated by crash history, the designer may provide clear zone distances greater than shown in Table 3-8. Clear zones may be limited to 30 feet for practicality and to provide a consistent roadway template if previous experience with similar projects or designs indicates satisfactory performance.

\*\*—Since recovery is less likely on the unshielded, traversable 3H:1V slopes, fixed objects should not be present in the vicinity of the toe of these slopes. Recovery of high speed vehicles that encroach beyond the edge of shoulder may be expected to occur beyond the toe of slope. Determination of the width of the recovery area at the toe of slope should take into consideration right-of-way availability, environmental concerns, economic factors, safety needs, and crash histories. Also, the distance between the edge of the through traveled lane and the beginning of the 3H:1V slope should influence the recovery area provided at the toe of slope.

Source: Roadside Design Guide (2002), AASHTO

### **3.8.43.8.4 Retaining Walls**

Retaining walls within the right-of-way shall be designed and constructed in accordance with the current WSDOT Design Manual, Standard Plans, and Standard Specifications. Walls having a vertical height over 4 feet measured from the bottom of the footings to the top of the wall shall be designed ~~in accordance with the uniform building code and will~~ and be stamped by a qualified professional engineer.

### **3.8.53.8.5 Street Trees**

With the exception of landscaped medians and vegetated LID stormwater management facilities, maintenance of landscape features located within County right-of-way shall be the responsibility of the fronting property owner. This includes watering, mulching, plant replacement and required pruning.

While Kitsap County encourages the planting of trees along public streets, some species have aggressive root systems which may cause damage to adjacent curbs, gutters, sidewalks, and utilities. In addition, some species are inappropriate for use because they block visibility, are susceptible to wind damage or drop fruit or debris. Appendix "A" contains a list of approved trees for given applications.

Trees located in the right-of-way ~~must~~ shall be planted to the following standards:

- A. 3.5 feet back from the face of curb (if planted in the clear zone, the tree shall not be allowed to grow to over 4 inch diameter at 6 inches above the ground)
- B. 5 feet from underground utility lines
- C. 15 feet from power poles

~~D. 10 feet from driveways~~

D. 10 feet from approaches, foliage shall not be allowed to restrict driver's visibility. Branches shall not be allowed between a height of 3 feet and 7 feet.

E. 20 feet from street lights or other existing trees

F. 30 feet from street intersections (a sight triangle should be evaluated when trees are planted near intersections)

G. If trees are planted near roads, sidewalks, or approaches provide acceptable root barrier to preclude root damage to pavement.

Where these standards cannot be met, plantings in the right-of-way are limited to shrubs having a mature height of 3.5 feet.

Prior to any digging within County right-of-way, an underground locate should be requested by calling 800-424-5555. Kitsap County is not responsible for private irrigation systems located in right-of-way unless the installation is performed under a permit to work in County right-of-way and all conditions of permit approval are met.

## Chapter 4

---

# Access and Intersections

## 4.1 4.1 Access Control

Access points to County roads are classified as private approaches or intersections. Intersection design criteria defined in the current edition of the *AASHTO Green Book*, *WSDOT Design Manual* and the *Manual on Uniform Traffic Control Devices* shall be used whenever a public roadway intersects another public road or a private approach ~~or if traffic signalization is warranted~~.intersects a public road.

Intersection location, spacing, and design are fundamental to managing roadway access and preserving roadway capacity. The functional classification of a roadway addresses the appropriate level of access control. The County Engineer may require the Project Engineer to furnish an access plan that the County can use to assess the impact of the proposed access on the County road system. For intersections with three or more lanes, the Project Engineer ~~must~~shall prepare signing, striping, and traffic channelization plans.

The general design criteria shown below are minimum guidelines only and may be modified to account for traffic volumes, topography, design speed, design vehicle requirements, and other conditions.

Access points shall be designed to provide adequate sight distance in both directions on the public roadway being accessed.

The following general design criteria for roadway intersections and approaches shall apply:

~~A.~~(1) Roadway intersections shall be located a sufficient distance from all curves to provide proper sight distance for vehicles on the intersecting road and on the through road.

~~B.~~(2) Multi-leg intersections (i.e., those with more than four legs) are not permitted within local road networks. In local road Networks, "T" intersections are encouraged. For arterial access, four-leg intersections are encouraged.

~~C.~~(3) Where approaches are on opposite sides of the road avoid positioning them where opposing left turning movements conflict with each other, especially in two-way left-turn lanes.

~~C.~~(4) Roundabout intersections taking the place of standard intersections, shall be designed in accordance with current AASHTO, FHWA and/or WSDOT standards and guidelines.

~~D.~~(5) In order to preclude encroachment on travel lanes, radii and any taper for right turn entry and exit should be consistent with the design vehicle's turning path requirements.

~~E.~~(6) Whenever a property has potential access from two or more roads, the County Engineer may refuse access to the higher classified road.

~~F.~~(7) Whenever a potential feasible access exists to any property from both a public road and private easement, the County Engineer may refuse new access to the public road.

~~G.~~(8) New access locations internal to the platting of property shall be unified whenever possible to create the fewest number of access points onto a County road. All subdivision lots shall access from interior roads only. Lots of record in existing formal plat subdivisions, short plats, and large lots not served by a minor or major approach shall be permitted one residential approach.

~~H.~~(9) Access to corner lots shall be from the lesser-classified road at the greatest distance possible from the intersection.

~~I.~~(10) The number of intersections shall be minimized as much as possible, particularly as the classification of the affected roads increase. Intersection spacing should be maximized wherever possible. Developments shall be limited to one ingress/egress per 300 lineal feet along a public arterial but may be required at greater intervals based on a traffic analysis.

~~J.~~(11) All access gates shall be installed so that no portion of the gate, open or closed, ~~is within the County right of way. Adequate space between the edge of roadway and the~~ gate appurtenances such as key pad islands, turnaround areas, etc. shall be ~~provided so that the entering vehicle is completely off the roadway, located within~~ County right of way. All gates shall meet the requirements of Kitsap County Code Title 14, Buildings and Construction, and require the approval of the County Fire Marshal and the local Fire District.

a. Gates installed across a shared-access facility, private road, tract or easement serving more than 50 ADT shall have a turnaround located in front of the gate to accommodate a SU vehicle and the ingress shall have two travel lanes.

b. Gates serving a single family residence, storm pond facility or agricultural area shall be set back from the county right of way or easement a minimum 20 feet. All other gates shall be set back a minimum of 50 feet.



~~K.(12)~~ A minimum of two access points, separated by no less than half the diagonal of the property or area served, shall be required for developments that ~~will~~ generate more than 1,000 ADT ~~or contain more than 100 homes,~~ unless other mitigating measures are approved by the County Fire Marshal.

(13) Preserve native vegetation and trees to the maximum extent feasible.

The number and location of intersections may be more restrictive than described herein if deemed necessary by the County Engineer. The County Engineer shall base the determination on existing and projected traffic volumes, channelization, signalization, and turning movements generated by the proposed project.

#### 4.1.1 Intersection and Access Spacing — Functional Area

Access points and intersections are a major source of accidents and congestion. Therefore, the spacing of intersections and driveways/approaches is a critical element in the planning and design of roadways. Access spacing can be especially challenging where development takes place on existing roads where land has

already been subdivided. While property owners have the right to reasonable access, roadway users have the right to freedom of movement and safe roads. An objective of these standards is to manage access to land developments while preserving the flow of traffic on County roads. Numerous studies have shown that sound access management reduces accidents and improves the operation of roads. New access points or intersections should not be located within the functional area of an existing intersection. For the purposes of these Standards, an intersection's functional area on the approach leg is considered to include the 95% queue length plus the minimum stopping sight distance measured from the stop line. Departure leg spacing shall be minimum stopping sight distance for arterials and 50 feet for local roads measured from the tangent curb line of the cross traffic.

~~For the purposes of these Standards, an intersection's functional area is considered to include any queue length plus the minimum stopping sight distance measured from edge of traveled way to edge of traveled way. Refer to Table 3-1 for minimum stopping sight distances at given design speeds.~~

## 4.2 Roadway Intersections

### 4.2

Roadway intersection guidelines encourage the preservation of capacity and safe operation of roadways. The following subsections provide the guidelines for roadway intersection location and design.

### 4.2.1 Angles

**4.2.1** An important intersection design characteristic is the intersection angle. The intersection angle is the angle between any two intersection legs. The preferred angle is 90 degrees. The allowable intersection angles are between 75 to 105 degrees. An approved deviation from the County Engineer is required when the following intersection configurations cannot be avoided.

~~a.A.~~ Intersections with offset legs.

~~b.B.~~ Intersections with more than four legs.

~~c.C.~~ Tee intersections where the major traffic movement turns.

~~d.D.~~ Wye intersections that are not a one-way merge or diverge.

e.E. Angle-points or short radius curves within the intersection.

f.F. Other non-standard intersection designs.

## 4.2.2 “L” Intersections—

**4.2.2** On very low volume roads (ADT  $\leq 400$ ), an “L” intersection (two legged, right angled intersection) may be desirable to address unique site constraints or planning objectives. Because there are only two legs, these do not meet the true definition of an intersection and generally do not require traffic controls. Nevertheless, “L” intersections are commonly used throughout the Cecountry and meet the objectives of safety and efficient design. “L” intersections shall be designed in accordance with the intersection standards in Section 4. Refer to ~~Figure 4-5~~Figure 4-1 5 for the required geometry and design considerations.

## 4.2.3 Corner Radii——

**4.2.3**—The geometric design of an intersection requires identifying and addressing the needs of all intersection users. For the design of right turn corners, there may be competing design objectives when considering the turning requirements of the design vehicle and the crossing requirements of pedestrians. To reduce the operational impacts of large trucks, right turn radii should be designed so that the truck can complete its turn without encroaching on the adjacent lanes at either the entrance or exit legs of the curve. This results in larger corner radii, which increases pavement area and higher vehicle turning speeds. The design elements of each intersection, including all radii, ~~must~~shall be based on expected volumes by direction of arrival and by expected vehicle characteristics. For local roads intersecting local roads, the minimum face of curb line radii required is 35 feet.

The designer ~~must insure~~shall ensure that corner radii accommodate required design vehicles without encroaching on the opposing lane or leaving the traveled way. Widening the travel lanes may be required to ensure that this requirement is met. Conventional turning templates or computer methods are routinely used for analysis of turning movements.

With approval from the County Engineer, partial lane encroachment may be allowed during turning movements on very low-volume roadways to reduce pavement area, or to allow curb bulb-outs to provide for roadway bioretention and/or promote pedestrian safety (shorter crossing distances).

### 4.2.4 Intersection Control

**4.2.4** Sight distance shall be provided at intersections to allow the drivers of stopped vehicles a sufficient view of the intersecting roadway to decide when to enter the roadway or to cross it. Specified areas along intersection approach legs and across their included corners should be clear of obstructions that might block a driver's view of potentially conflicting vehicles. These specified areas are known as clear sight triangles. The dimensions of the legs of the sight triangles shall be designed for the design speed of the facility being entered. Departure sight triangles for intersections with stop control on the minor road should be considered for three situations: Left turns from the minor road; Right turns from the minor road; and Crossing the major road from a minor-road approach. The following table 4-1 depicts minimum lengths for approach grades of 3 percent or less. If unusual design or safety considerations warrant increased sight distance, the requirements ~~will~~shall be determined by the County Engineer.

**Table 4-1. Design Intersection Sight Distance**

<u>Design</u> Posted Speed (mph)	20	25	30	35	40	45	50
Left Turn (feet)	225	280	335	390	445	500	555

Crossing / Right Turn (feet)	195	240	290	335	385	430	480
------------------------------	-----	-----	-----	-----	-----	-----	-----

Source: Policy on Geometric Design of Highways and Streets (~~Latest Fifth~~<sup>Sixth</sup> Edition), AASHTO

Values are based on stopped condition, driver's eye height of 3.5 feet set back 14.5 feet from the edge of traveled way, or stop line and an object height of 3.5 feet ~~as illustrated in Figure 4-4.~~ Clear sight triangle distance ~~must~~<sup>shall</sup> be calculated for situations that involve road approach grades in excess of 3 percent by using the adjustment factors listed in AASHTO.

In situations where the clear sight triangle distance is questionable, the County Engineer may require the Project Engineer to prepare a clear sight triangle diagram, together with appropriate field measurements, and submit them for review prior to the approval of the construction plans. The diagram and measurements shall be stamped and signed by a qualified Professional Engineer. Where the clear sight triangle falls on private property, a sight easement ~~must~~<sup>shall</sup> be provided to maintain line of sight.

### 4.2.5 Geometrics-

**4.2.5** At the intersection of different classifications of roads (e.g. a minor arterial with a collector arterial), the centerline slope and typical cross section of the higher classified road should be carried through the intersection. The centerline slope and typical cross section of the lower classified road should match in a manner that will not interfere with the smooth movement of traffic in the travel lanes of the higher classified road. Where two roads of the same classification intersect, the centerline grade shall be matched at the center of the intersection with cross slopes varying through the intersection to allow stormwater management. All classes of local roads shall be treated as the same classification for purposes of this paragraph. Profile grades for all roads (public or private) intersecting with a County road (existing or proposed) shall be designed and constructed so that adequate sight distance is provided.

### 4.2.6 Medians—

**4.2.6** Medians at roadway intersections are optional design features. Medians should be as wide as feasible but of a dimension in balance with other components of the cross section. Median width shall be additional to, not part of, the specified width of traveled way. For medians 30 feet or wider each intersecting road location must be considered a separate intersection. Median edges shall be similar to outer road edges: either formed vertical curb and gutter, or shoulder and ditch, provided that clear zone requirements are met. A median may be grassed, landscaped, ~~or~~ surfaced with pavement or used for LID facilities. Medians shall be designed so as not to limit turning radii or sight distance at intersections. No portion of a side road median may extend into the right-of-way of the intersecting road. The County Engineer may require revisions to medians as necessary to provide for new access points and to maintain required sight distance. Non-yielding or non-breakaway structures shall not be installed in medians. Street trees may be planted in medians subject to approval by the County Engineer.

## **4.3** 4.3 Road Approaches

Road approach shall mean a connection providing ~~private~~ vehicle access to or from the County road system. Any person, firm, partnership, association, joint venture, corporation, or other entity desiring to construct or alter a permanent or temporary approach ~~must~~shall obtain a Road Approach Permit from Kitsap County Department of Community Development. A copy of the permit shall be available for inspection at the site during construction. Any change in land use or any improvement to an existing site that increases traffic volumes using an existing approach ~~will~~shall require a new Road Approach Permit.

Road approaches ~~will~~shall meet the design requirements set forth in these standards. Road approach design includes location, spacing, sight distance, throat length and width, radii, angles, stormwater management, and vertical/horizontal grades.

The design of a road approach ~~needs to~~shall address the type of vehicles anticipated, traffic volume, and land use activities being accessed. Road approach locations ~~need to~~shall be carefully determined to minimize interference with normal roadway operation. Road approaches need to be constructed where sight distance is adequate for safe traffic operations. Road approaches are classified as residential or major.

### 4.3.1 Residential Road Approach

~~4.3.1~~ A residential road approach is used to serve up to ~~two~~four single family residences or ~~one~~two duplex ~~unit~~units. Residential road approaches shall be constructed in accordance with the specific geometric requirements found in ~~Figures 4-1 and 4-2~~Figures 4-2 and 4-3. Grading and restoration of the ~~driveway beyond the end of the road~~ approach shall be done to provide a smooth, passable, and safe transition to the ~~approach~~road connection.

Spacing of residential road approaches shall comply with Section 4.1, constructed the maximum practical distance, ~~but in no event, preferably not~~ less than ~~100~~80 feet from an arterial or local road sub-collector intersection or less than ~~50~~20 feet from a local road minor ~~or cul-de-sac~~ intersection. The distance is measured along the property line from the intersecting road right-of-way line to the nearest edge of the approach width.

### 4.3.2 Major Road Approach

~~4.3.2~~ A major road approach is used to serve multi-family and commercial uses. ~~When multiple access points are desired to serve one site, each approach will conform to the appropriate standard.~~ The number, location, and size of major road approaches shall be determined by the volume and type of traffic generated by a proposed development, other road approaches in the vicinity, the amount of property frontage along the road, and existing channelization/ traffic controls. When multiple major road approaches to one parcel or development are permitted, they shall be spaced as described in Section 4.1.1. ~~A minimum of two road approaches will be required for developments that will generate an ADT of 1,000 or more, unless other mitigating measures are approved by the County Fire Marshal.~~

Major road approaches shall meet the spacing requirements described in Section 4.1.1, except where physical site conditions and spacing of existing road approaches may cause the County Engineer to require another location. The distance is measured along the property line from the intersecting road right-of-way line to the edge of the road approach width. New road approaches that would create a four-legged intersection are desirable. Access to a corner lot with a frontage length less than



the minimum required for an approach ~~will~~shall be established on a case-by-case basis by the County Engineer and the road approach shall be placed at a location to maximize safety.

Major road approaches shall be constructed in accordance with specific geometric requirements provided in ~~Figures 4-1 and 4-3~~Figures 4-4 and 4-5. Grading and restoration beyond the end of the road approach shall be done to provide a smooth, passable, and safe transition.

Access to the abutting property shall be controlled along the access centerline from the county right of way or easement into the property for a distance of 50 feet minimum.

### 4.3.3 Construction Criteria—

**4.3.3** Wherever possible, the outer edge of an approach shall not be constructed closer than 70 feet to a bridge, culvert, or other structure that may warrant end protection using barriers or guardrail.

All approaches shall be paved to the right-of-way line or 3 feet beyond the end of the radius, whichever is greater, with a minimum of ~~23~~-inch compacted depth of ~~hot mix asphalt~~Hot Mix Asphalt (HMA) over minimum 2-inch compacted depth crushed surfacing top course, or

\_minimum 6-inches of reinforced Portland Cement concrete. If an existing County maintained road is gravel, an approach constructed of 4-inch compacted depth crushed surfacing top course is acceptable.

#### **4.3.4 Temporary Road Approach**

**4.3.4** A temporary road approach shall be constructed in accordance with the residential road approach requirements except paving. Grading and restoration beyond the end of the road approach shall be done to provide a smooth, passable, and safe transition to the existing facility. Temporary road approaches should preserve native vegetation to the extent feasible, and avoid existing trees.

No site work may commence until a permit for the temporary road approach has been issued and the temporary approach constructed. All temporary road approaches ~~must~~shall be removed and the right-of-way restored within 180 days from the date of approval. One extension of this ~~time~~ permit time may be granted for a period not to exceed an additional 180 days.

#### **4.3.5 Failure to Construct Properly**

**4.3.5** In addition to all other enforcement remedies, any person, firm, partnership, association, joint venture, corporation or other entity who fails to construct an approach properly ~~will~~shall be required to compensate the County for the improvement or removal of the approach. Compensation shall include administration time as well as equipment and materials to remove or improve the approach. Reimbursement shall be made to the Kitsap County Department of Public Works.

**~~4.3.6 Fees~~** ~~Fees required under this Ordinance and/or the Road Standards are as specified in the Kitsap County Development Permit Fee Schedule, Kitsap County Code Section 21.06.100, as it now exists or is hereafter amended.~~



# Traffic Control and ~~Ill~~umination Street Lighting

## ~~5.1~~ 5.1 Signs

All traffic signs and installations ~~must~~shall conform to the latest edition of the Manual on Uniform Traffic Control Devices (MUTCD), as ~~modified~~adopted by the Secretary of the Washington State Department of Transportation ~~Commission~~ per RCW 47.36.030. The Developer is responsible for purchase and initial installation of all traffic control devices.

### 5.1.1 ~~Regulatory, Warning, and Guide Signs~~—

~~5.1.1~~ Signs give motorists the information they need to safely and legally drive on public roadways. The MUTCD contains information on the intended use and placement of signs. It also contains information on the size of standard regulatory and warning signs. All traffic control signs shall be installed before a road is opened to vehicular use. The County Traffic Engineer ~~will~~shall approve all traffic control signs for type, size, legend, reflective facing material, and mounting device. This also applies to all major road approaches to County ~~right~~rights of-way.

~~5.1.2~~ ~~County Road Name Signs~~—~~On roads in plats that are to be turned over to the County for maintenance, the Department of Public Works shall furnish, install and maintain the necessary signs. However, reimbursement for the initial installation of all traffic signs shall be made to the Department of Public Works. Road name signs are considered a safety item and reimbursement is required prior to road construction approval.~~

### 5.1.2 ~~Private Road Name Signs~~—

**5.1.3** The County does not fabricate, install or maintain private road name signs on private property. If a private road intersects with a maintained public road, a street name sign, built to County specifications, can be purchased from the County. ~~This sign will be fabricated, installed in the public right-of-way and maintained by the county as long as it remains under County jurisdiction. The public does have the option to purchase their own sign and install it following approval by the Kitsap County Traffic Engineer. The sign shall conform to the MUTCD and County standards.~~

## **5.2** 5.2 Delineation

Delineation are the pavement markings, guideposts, and raised pavement markers used on and adjacent to the roadway to define vehicular travel paths. The MUTCD provides delineation placement guidelines. Pavement markings are classified as either longitudinal

or transverse. Roadway pavement markings or other traffic delineators shall be installed in accordance with approved plans, and the latest edition of the MUTCD.

Kitsap County has the following pavement marking requirements:

~~A.(1)~~ All pavement markings with the exception of long-line paint stripes and Raised Pavement Markers (RPMs) shall be in Thermoplastic.

~~B.(2)~~ Channelizing lines shall be 8 inches in width using Thermoplastic material (i.e. gore lines, islands).

~~D.(3)~~ Turn Lane-Use Arrows, Through Lane-Use Arrows, Turn and Through Lane-Use Arrows, and Lane-Reduction Arrows shall conform to Figure 3B-21~~24~~ in the MUTCD.

~~E.(4)~~ Stop Lines shall be 18 inches in width and long enough to cross the lane or travelway.

~~F.(5)~~ Crosswalk markings shall be installed in accordance with the ~~WSDOT Standard Plans. The length of the crosswalk lines shall be 10 feet on Arterial Roads not controlled by a stop sign or signal. detail shown in the Figure 5-2.~~

~~G.(6)~~ Speed Hump markings shall conform to Figure 3B-29-Option A, in the MUTCD, ~~no narrow elongated style. See Figures A-1 and A-2.~~

~~H.(7)~~ ~~Raised Pavement Markers, RPMs~~~~Raised Pavement MarkersRPMs~~, when specified, shall be installed in accordance with the WSDOT Standard Plans Manual. ~~Pavement Markers shall not be recessed unless specified.~~

When construction requires traffic to use lanes not normally used, existing pavement markings may confuse motorists. Markings that create confusion should be completely removed and replaced with new markings before the path is open to traffic. The intended path should be clearly defined during the day, night, and twilight hours, as well as under wet and dry road conditions. Markings that ~~must~~will be visible at night shall be ~~reflective-retroreflective.~~

~~Kitsap County may choose to perform all or part of the signing and delineation work and charge the applicant for actual costs incurred by the County. The Project Engineer will indicate on the road construction plans, before approval, that the Department of Public Works is to be contacted 48 hours prior to construction. This will enable the County to schedule the signing and delineation work and make arrangements to charge the proponent. After the County completes the work, reimbursement to the Department of Public Works shall be made before the County accepts the overall project for dedication or maintenance and before the County releases any financial guarantee. Before any signing or delineation work takes place, the Project Engineer shall contact the Department of Public Works and schedule an on-site meeting to preview the work, markings, layout, and method of construction.~~

## **5.3** 5.3 Signals

Signals are traffic control devices used to regulate vehicle and pedestrian movements or warn of a particular condition or hazard. Section IV in the *Manual of Uniform Traffic Control Devices* (MUTCD) discusses the types of signals and their applications, and provides warrants and guidelines for appropriate signal installation. All signal systems shall be planned, designed, and constructed in coordination with the Department of Public Works Traffic Operations Division.

### **5.3.1** Design Criteria

**5.3.1** When designing traffic signal systems for the County, the design shall be in accordance with the National Electrical Code, conform to all the pertinent requirements of these standards, policies, and directives, and utilize the standards and practices outlined in the current or amended editions of the following publications:

- A. *MUTCD*
- B. *WSDOT Design Manual*
- C. *WSDOT Traffic Manual*
- D. *WSDOT Standard Specifications*

### **5.3.2** Design Guidelines



**5.3.2** The following is a list describing the typical process and guidelines used for the installation of a traffic signal system for the County.

- A. Evaluate the ~~purposed~~proposed intersection to verify that warrants for a traffic signal are met in accordance with the MUTCD.
- B. The designer should contact the County for specific requirements prior to beginning work on the signal design.
- C. Traffic studies shall be conducted and the traffic pattern and volume results used to determine the appropriate number of lanes, length of turn pockets and signal phasing.
  - D. Signal phasing is the ordered sequence of all traffic movements at a signalized intersection. When establishing the phasing for a traffic signal, the designer ~~will~~shall follow the appropriate standards as well as consider the level of service, safety, and efficiency needs of the County. In addition, the designer should follow the preferred directional phasing layout as shown in ~~Figure 5-1~~Figure 5-3 Kitsap County Public Works Traffic Signal Phasing diagram as closely as

- D. ~~As~~ possible. The County ~~will~~shall determine the operational signal timing, which determines the time interval assigned to each traffic movement.
- E. Pedestrian activity shall be considered at all traffic signal installations. For each pedestrian crossing, a pedestrian push button assembly and Accessible Pedestrian Signals shall be provided. In consideration of the Americans with Disabilities Act (ADA) requirements, curb ramps shall be constructed on or near the crosswalks at intersections.
- F. Permanent traffic signal supports shall be metal standard and mast arm. Timber strain poles are allowed only on temporary systems.
- G. Controller cabinet location should be determined early in the plan development. The designer should always consider the safety of the driving public and signal system equipment when selecting a location. The cabinet shall not restrict the lateral visibility of vehicle traffic. The cabinet location should provide easy access for maintenance personnel and allow as much as possible simultaneous viewing of the controller and signal displays. See Figures 5-4 2 and 5-5 3.
- H. The ~~County will~~Developer shall supply all traffic signal cabinets, controllers, and necessary equipment inside the controller cabinet. Ninety (90) days prior to installation, the Developer shall deliver the cabinet, controllers, and internal components to the County for testing. Once testing is approved, the Developer is responsible for transporting from the County shop to the job site. For signal installations initiated by a private developer or another governmental agency, the County ~~will~~shall bill the appropriate individual or agency for all required equipment and testing. ~~All equipment supplied by the County must be pre-paid before it will be purchased and installed.~~
- I. All underground conduits for a traffic signal installation shall be PVC schedule 80. Galvanized rigid steel is to be used for all 90 degree bends and the first 10 feet of electrical service on pole mounted feeds.

- J. Detailed signal contract plans shall be submitted to the County for review and approval by the appropriate authorities. The plans shall be submitted for review and approval prior to being advertised for construction. Design submittal guidelines and procedures for signal design plans are outlined in section 6.2.6 of these standards.
  
- K. Final inspection of the project by the County ~~will~~shall be required. After final inspection affirms the installation is consistent with current signal design standards and after receipt of a formal letter of agreement, the County ~~will~~shall assume ownership, operational authority, and responsibility of the traffic signal.

L. See Section 8.9 for initial signal turn on requirements.

## 5.4 5.4 Illumination

Transportation facility illumination is necessary to facilitate visual perception of conditions or features that require additional driver or pedestrian alertness. ~~Any proposal that would provide less than basic illumination at these facilities will require prior approval by the County.~~

### 5.4.1 Design Guidelines

**5.4.1** Designed illumination systems to be owned by the County shall be designed and installed in accordance with the National Electrical Code and the current Washington State Department of Transportation Standard Specifications, ~~and shall follow the applicable standards for basic illumination outlined in the current or amended edition of the following:~~

~~A. WSDOT Traffic Manual~~

WSDOT

### 5.4.2 Street Lighting Requirements

~~B. Illumination design shall be to the Design and Maintenance of Roadway and Parking Facility Lighting American National Standard Practice for Roadway Lighting, ANSI/IES RP-8-20184 or latest version. or Design Manual~~

~~A. Basic Guide for Roundabout Lighting, IES DG-19-08. Design projects shall include illumination ~~is required at for~~ the following locations:~~

~~1. Channelized intersections.~~

~~A. Signalized or channelized intersection. When ~~raised median the~~ channelization is ~~installed within the traveled way~~ delineated with curbs, raised medians, or islands, illuminate the raised channelization from the beginning of ~~an arterial to separate opposing directions of the approach taper.~~~~

~~2.B. Railroad crossing with gates or signals if there is nighttime train traffic and guide or prohibit left turning traffic.~~

~~C. As a part of Roundabouts.~~

~~3.D. Continuous street lighting for major roadway construction or reconstruction projects, continuous street illumination shall be provided on principal and minor arterials that are in areas with a highly dense concentration of of high density urban commercial development or in areas that have a significant concentration of both or moderate density commercial and high density multi-family development.~~

~~4. Railroad Crossings Mid block crosswalks with gates or signals if there is regular nighttime train traffic pedestrian activity.~~

~~E. At midblock crosswalks where a minimum of 20 pedestrian crossings regularly occur in a one-hour period between dusk and dawn, and where the roadway has a posted speed greater than 25 mph, the crosswalk shall meet ANSI/IES light levels.~~

~~A. Designed Intersection with a marked crosswalk across the uncontrolled legs that has regular nighttime pedestrian activity and a posted speed limit greater than 25 mph on the uncontrolled legs.~~

~~F. Where marked crosswalks are present on uncontrolled legs of isolated intersections, and where a minimum of 20 pedestrian crossings regularly occur in a one-hour period between dusk and dawn, and where the roadway has a posted speed greater than 25 mph across the uncontrolled leg, the crosswalk horizontal illumination shall meet isolated intersection light levels.~~

~~Any proposal that would provide less than basic illumination at the above facilities shall require prior approval by the County.~~

### 5.4.3 Intersection Delineation Partial or Beacon Street Lighting

~~Intersection delineation Partial or beacon street lighting will be considered where a change in direction of the major routes occur or as a safety mitigation for nighttime collisions susceptible to correction with lighting.~~

~~B. Designated illumination systems to be owned by the County shall be inspected by the Washington State Department of Labor and Industries, Electrical Inspection Division, or applicable electric utility.~~

~~C. Maintenance Beacon lighting systems to be conveyed to Kitsap County shall be planned in coordination with the Department of Public Works Traffic Operations Division. Maintenance Beacon lighting is typically placed on existing wooden poles when available, or on new wooden poles when existing poles are not available. This spot lighting provides illumination enhancement at locations where nighttime accidents may be mitigated by its installation, or in less developed areas where commercial~~

~~development has necessitated channelized roadway intersections.~~ If maintenance beacon lighting is required or requested on a project, Public Works ~~will~~shall coordinate with Puget Sound Energy for its location and installation. ~~Electricity for maintenance lighting is typically paid by adjacent property owners.~~ County owned ~~maintenance~~ lighting shall be ~~a minimum 200-watt High Pressure Sodium lamp with a cut-off lens~~LED type lamps using 240-volt power supply.

~~D.~~ At some locations, franchised electrical utilities or junior districts may own, operate, and maintain street lights within the County right-of-way under the provisions of franchise agreements with Kitsap County. Kitsap County does not coordinate the installation, maintenance, or billing of these utilities or districts.

~~E.~~ No private individuals or homeowner associations shall install lighting within the County right-of-way. Privately owned and maintained lighting shall be located outside of the County right-of-way. Private entity must coordinate with PSE and pay for installation and monthly fees. Historically, electricity for beacon lighting has in some cases been paid by adjacent property owners; however, this is no longer the practice.

|



## Chapter 6

---

# Plan Preparation and Submittal

## ~~6.1~~ 6.1 General Criteria

~~A.(1)~~ A.(1) All road construction or reconstruction plans shall be prepared by and bear the stamp of a qualified Professional Engineer, licensed in the State of Washington.

~~B.(2)~~ B.(2) Construction plans for roads accessing state highways shall be submitted by the Project Engineer directly to WSDOT. All requirements, signed agreement or approval for the intersection or road approach ~~must~~shall be obtained by the developer before final plan approval ~~will~~shall be granted by Kitsap County. A copy of the approved plan from WSDOT shall be submitted to Kitsap County before final plan approval. Where WSDOT requirements exceed these Standards, WSDOT standards shall govern.

~~C.(3)~~ C.(3) ~~It shall be the responsibility of the~~The Project Engineer ~~to contact~~contacts the Kitsap County Department of Community Development for road name approval.

## ~~6.2~~ 6.2 General Plan Formatting

### 6.2.1 Cover Sheet

**6.2.1** Road construction plans submitted to the County for review and approval shall have a plan cover sheet containing the following information:

~~A.~~ A. An overall site plan drawn to an appropriate scale showing the entire development and road system network, including its connection to an existing County road or State highway. In the event the site is too large for the required information to be shown for the entire project site, the site plan view ~~must~~shall serve as an index to subsequent detailed plan sheets.

~~B.~~ B. Easements, tracts, stormwater management facilities, all buffer and screening areas.

~~C.~~ C. Standard notes that are applicable to the project.

## 6.2.2 Horizontal Plan—

**6.2.2** Horizontal plans of the project shall include the following information:

- A. A. Road alignments with 100-foot stationing, preferably increasing to the north or east and reading from left to right; stationing at points of curve, tangent, and intersection; ties to section or quarter corners at each end or other established and monumented survey control points; and each section crossing.
- B. Section, township, and range on each sheet; plat or project name.
- C. Bearings on road centerline.
- D. Curve data, including radius, point of intersections, delta, arc length, and tangent length on all horizontal lines.
- E. Right-of-way lines and widths for the proposed road and intersecting roads. The plans shall show dimensioned lot lines, tracts, easements areas, and lot numbers.
- F. All topographic features within right-of-way limits and sufficient area beyond to resolve questions of setback, slope, stormwater management, access onto abutting property, and road continuations. This shall include, but is not limited to, ditch flow lines, contours, utility locations, fences, existing curbing and approaches, pertinent trees and shrubbery, and other appurtenances that would affect the construction of the project.
- G. Identification of all existing County roads and adjoining subdivisions when it is pertinent to the scope of the project.
- H. Typical roadway cross-section(s) of proposed road.

- I. Scale: 1" = 50' is preferred, no scale smaller than 1" = 100' ~~will~~shall be accepted, unless it is the overall site plan sheet. Details for clarification may be shown at a convenient scale, normally 1" = 10' or 1" = 20'.
- J. Utilities and structures within and adjacent to the right-of-way meeting the required clear zone distance.
- K. Delineate and identify areas of easements (i.e., slopes or maintenance) outside the right-of-way that are caused by construction of the proposed project.

### 6.2.3 Profile Elements—Plan

**6.2.3** Profile drawings of the project shall include the following information:

- A. A. Road, stormwater, all existing or proposed utilities, and original ground profiles with stationing the same as the horizontal plan, preferably reading from left to right, to show stationing of points of curve, tangent, and intersection of vertical curves, with elevations.
- B. Road grade and vertical curve data including K value; road to be measured at centerline.
- C. Vertical scale: 1" = 5' is preferred. Clarifying details may be shown at a convenient scale. Use 1" = 10' for vertical when horizontal plans are 1" = 100'.
- D. D. When roads end at a property line, the existing ground profile shall be continued a minimum of 200 feet to show that the proposed vertical alignment is reasonable.
- E. E. Description of vertical datum; controlling bench marks; and project bench marks with sufficient description and elevation frequency no less than every one half mile.

### 6.2.4 Intersection Plan Details—

**6.2.4** Intersection plan details for the project shall include the following information:

When either of the road centerline profile grades within 35 feet of an intersection has a gradient of 8 percent or more, or less than 1.5 percent, an intersection detail drawn to a scale of 1" = 20' ~~must~~shall be included as a detail on the road construction plans. The detail ~~will~~shall show spot elevations every 25 feet on the road centerline, around the curb return, and grate elevations for stormwater management structures in the intersection. The intersection plan ~~must~~shall be clearly detailed to show flow line grades and how surface stormwater management ~~will~~shall be controlled at the intersection. Curb return data for lesser gradients shall be shown on the road construction plans.

### 6.2.5 Channelization and Signage Plan—

**6.2.5** All plans submitted for approval for any improvements to County roads shall include a channelization plan set. This plan set shall include all existing channelization for the entire length of the impacted roadway, and all proposed channelization after the improvements are completed. ~~Channelization plans shall include scaled drawings showing the following for both existing and proposed signs, pavement width, shoulder width, corner radii, traffic islands, median dividers, pavement tapers and transitions, lane lines, center lines, lane widths, turn lanes, crosswalks, illumination, traffic signals, adjacent approaches, sidewalk and walkways. The plans shall show all pavement markings to be obliterated, and signs to be removed. The plans shall be submitted with sufficient detail to allow the Department of Public Works to determine the scope and extent of the work including type and amount of material and the length of time to complete the work. If there are interim control plans proposed, they also must be included in the plans.~~

The plans shall contain the following:

- a. A. A sign schedule in tabular format that includes location, type, legend, sheeting, size, and mounting.
- b. B. Channelization including pavement width, shoulder width, corner radii, traffic islands, median dividers, pavement tapers and transitions, lane lines, centerlines, lane widths, and turn lanes.
- c. C. Adjacent approaches, sidewalk and walkways.
- d. D. Delineation including crosswalks, arrows, raised pavement markers, guideposts.
- e. E. Illumination and traffic signals.
- f. F. All pavement markings to be obliterated, and signs to be removed.
- ~~g. Sufficient detail to allow the Department of Public Works to determine the scope and extent of the work including type and amount of material and the length of time to complete the work. If there are interim control plans proposed, they also must be included in the plans.~~
- h. G. Scale: 1" = 50' is preferred, no scale smaller than 1" = 100' ~~will~~shall be accepted.

H. These standard notes:

i.

~~4.1)~~ Contractor to provide all thermoplastic markings, paint striping, and signage.

~~2.2)~~ Contractor to remove all existing pavement markings in conflict with proposed markings.

~~3.3)~~ All pavement markings shall conform to the latest edition of the Manual on Uniform Traffic Control Devices, unless otherwise noted.

~~4.4)~~ Contractor shall contact Public Works Traffic Division prior to installing pavement markings or other traffic delineators on County ~~right-rights~~ of-way.

### 6.2.6 Signal and Illumination Plan

**6.2.6** All information provided on signal and illumination plan sheets should be clear and easy to read. Signal and Illumination plans shall include as a minimum the following information:



A. A. Signal Plans

~~4.1)~~ \_\_\_\_\_ Plan sheet shall show a north arrow, appropriate scale bar and the major arterial oriented horizontal on the plan sheet.

~~2.2)~~ \_\_\_\_\_ Design elements should be clearly identifiable shown as existing, proposed and future design elements. All proposed signal equipment including signal poles, mast arms, vehicle heads, pedestrian heads, pedestrian push buttons, signs, junction boxes, conduit, loops, video cameras, controller and service cabinet and foundations ~~shall be shown in bold.~~

~~3.3)~~ \_\_\_\_\_ Phase diagram and signal display layout of all vehicle and pedestrian signal heads shall be shown on the plan sheet. Designer shall contact the County to confirm signal phasing prior to the first submittal. The County prefers to use a directional traffic signal phasing layout with phase ~~ϕ~~ 6 assigned to the northbound direction as shown in ~~Figure 5-1~~ figure 5-3 † Kitsap County Public Works Traffic Signal Phasing diagram.

~~4.4)~~ \_\_\_\_\_ All existing and proposed right-of-way information shall be shown and labeled on the plans, including easements needed for signal equipment.

~~5.5)~~ \_\_\_\_\_ All proposed curbs, sidewalks and channelization striping, including crosswalks and stop bars shall be shown on the plans.

~~6.6)~~ \_\_\_\_\_ Plan shall show construction centerline for each road with stationing labeled every 100 feet.

~~7.7)~~ \_\_\_\_\_ All proposed and existing underground and overhead utilities shall be shown and labeled on the plans.

~~8.8)~~ \_\_\_\_\_ Power source location shall be shown and labeled.

|  
9.9) Signal related signing should be shown and labeled.

| **B. B. Schedules**

| 4.1) Wire schedule including run number, conduit size, and wire type.

| 2.2) Junction box schedule including junction box type and approximate location.

~~3.3)~~ Pole schedule shall include signal standard details, wind load calculations, foundation details, pole orientation attachments and base details.

~~4.4)~~ Luminaire schedule including location, pole type, lamp type and wattage, mounting height, and base type.

~~C.~~ C. Wire diagram showing the wiring schematic for all signal heads, pedestrian heads, pedestrian push buttons, preemption detectors, loops, video cameras and their terminations in the cabinet.

~~D.~~ D. General Notes and Construction Notes.

## ~~6.3~~ 6.3 Time Limitation of Approval

The approval of road construction plans shall be valid for a time period not to exceed 3 years from the date of approval.

## ~~6.4~~ 6.4 Submittal Procedure

*Plans for proposed road construction or reconstruction shall meet the submittal requirements used for Site Development Activity Permits-(SDAP). Contact the Department of Community Development for specific submittal requirements.*

## ~~6.5~~ 6.5 Changes to Approved Plans

From time to time, field conditions encountered during construction require modification to the design contained in the approved construction plans. Prior to making any adjustments or changes to the approved construction plans, the Project Engineer shall first receive approval from the County Engineer for such changes. Changes shall be submitted to the Department of Community Development using the ~~Site Development Activity Permit~~SDAP procedures ~~and the guidelines found in WAC 196-23-020~~. Proposed modifications that the County Engineer deems substantial shall require additional review fees and re-issuance of the required permit. Minor proposed modifications may be accepted by the County Engineer without requiring the re-issuance of the accepted permit or the payment of additional review fees.



## Chapter 7

---

# Utility Installation ~~+/~~ Work In County Right ~~-~~ of ~~-~~ way Way

## ~~7.1~~ 7.1 Permits

No person, firm, partnership, association, joint venture, corporation or other entity shall: construct, adjust, repair or relocate any utility line, or construct any new or alter any existing roadway feature in Kitsap County ~~right~~ rights of ~~-~~ way without first obtaining a permit from the Kitsap County Department of Public Works. A permit is not required for routine maintenance activities or repairs to aboveground utilities. ~~Utility relocation work completed in conjunction with a County Road Improvement Project does not require a permit.~~ The applicant is required to be a qualified licensed and insured contractor in the State of Washington. Plans, drawings or other details that ~~will~~ shall enable the County to determine the location, size, length, time period, and purpose of the permit being sought shall be furnished by the applicant. The applicant is responsible for obtaining all applicable permits required by other agencies. All permits that extend or alter existing and new waterline installations require review and approval by the Fire Marshal prior to application.

### ~~7.1.1~~ 7.1.1 Emergency Repairs

- A. A permit need not be obtained before performing emergency repairs upon existing underground utilities where the public health, safety, and welfare is threatened if immediate repairs are not made.
- B. As soon as practicable after the need for emergency work is discovered or after the emergency repairs have been made, the person, firm, partnership, association, joint venture, corporation, or other entity intending to make or having made the emergency repairs shall notify the Department of Public Works regarding the location, extent, and nature of the repairs.
- ~~C.~~ C. On the next working day immediately following the date of the emergency repair, the public or private entity having made such emergency repairs shall submit an application for a permit to the Department of Public Works and shall comply with the Road Standards insofar as possible as determined by the Department of Public Works.

Fees

~~7.2~~ 7.2

~~Fees required under this Ordinance and/or the Road Standards are as specified in the Kitsap County Development Permit Fee Schedule, Kitsap County Code Section 21.06.100, as it now exists or is hereafter amended.~~

## 7.3 Sureties, Liability Insurance, and Indemnification

### 7.2.1 Surety Bond-

**7.3.1** The term “Bond” is defined as a financial guarantee in the form of a surety bond or assignment of funds, from a corporation authorized to do the business of surety in the State of Washington. The bond is required to ensure compliance with all permit conditions and shall be kept in full force and effect for a minimum of two years following acceptance of the work as complete by Kitsap County. The bond shall be in favor of the Department of Public Works and is required prior to permit approval. The amount of the bond shall be as determined by Kitsap County.

Prior to the final approval of construction, a maintenance bond or other acceptable surety must be posted and maintained by the applicant for a period of two years. The maintenance bond or surety shall guarantee the improvements constructed under the right of way use permit against design and material defects and failures in quality and shall guarantee that the facilities constructed under the permit will be regularly and adequately maintained throughout the maintenance period. At the end of this time, the County will inspect the improvements and, when the improvements are determined acceptable the County will take over the maintenance and operations of the improvements. The amount of the maintenance bond or surety shall be ten percent (10%) of the estimated construction cost of the improvements requiring maintenance, or five thousand dollars (\$5,000.00) whichever is greater. The construction cost of the facilities requiring maintenance shall be estimated by a professional engineer and is subject to approval of the County Engineer.

If a person, firm, partnership, association, joint venture, corporation, or other entity locates, installs, adjusts, repairs or relocates underground utility lines on a regular basis, the Department may allow such entity to post a blanket bond in an amount no less than five thousand dollars. If an entity that has posted a blanket bond thereafter makes application for a permit, on a project of such magnitude that the County determines that the -amount of the blanket bond is inadequate, the County may require a separate, additional bond.

### 7.2.2 Waiver of Bonding Requirements—

**7.3.2** The bonding requirements described above may be waived at the discretion of the County Engineer.



### **7.2.3 Commercial Liability Insurance**

**7.3.3** Prior to beginning any work, and through the term of the maintenance bond, the applicant shall maintain commercial general liability insurance in the amount of not less than one million dollars (\$1,000,000) combined single limit bodily injury and property damage, with a two million dollar (\$2,000,000) aggregate. Prior to issuing the permit to work in the right-of-way, a permit applicant ~~must~~shall provide the County with a certificate of insurance, signed by the insurance agent and the permit applicant. The policy shall be endorsed and the certificate shall name Kitsap County as an additional insured on the policy with respect to activities performed under this permit and through the term covered by the maintenance bond. The policy shall be endorsed and the certificate shall reflect that the insurance provided shall be primary insurance and any insurance or self-insurance carried by the County shall be excess and not contributory to that provided by the applicant. If, for any reason, a material change occurs in the insurance coverage during the period of time required by this provision, such changes shall not become effective until forty-five (45) days after Kitsap County has received written notice of such changes.

### **7.2.4 Indemnification**

**7.3.4** The holder of any right-of-way permit shall have no recourse whatsoever against Kitsap County or its officials, boards, commissions, agents, or employees for any loss, costs, expenses, or damages arising out of any provision or requirement of the permit or the Road Standards, or because of Kitsap County enforcement activities. Granting of a franchise or permit shall not imply or be construed to mean the county shall be responsible for the design, construction, or operation of the facility or for public safety during the facility's installation, operation, or maintenance.

## ~~7.4~~ 7.4 General Installation Guidelines

All utility installations shall be designed in accordance with the standards, codes and regulations applicable to the type of utility, including those described throughout this document. ~~The methods of installation and materials used shall conform to the codes and standards promulgated by government and by the industry.~~

Utility installations shall be located to minimize the need for later adjustment, to accommodate future roadway improvements, and to provide service access to such installations with minimum interference to roadway traffic. If, while reviewing applications for work in the right-of-way, the County determines that a proposed utility location interferes with a future project identified in the County's ~~Six~~-year Transportation Plan (TIP), ~~Surface and~~ Stormwater Capital Facilities Plan, or ~~Wastewater~~ Sewer Utility Capital Facilities Plan, the utility will be required to locate elsewhere. The County will aid the applicant in determining a new location.

Installations placed parallel to the road alignment will be located as near as practicable to the right-of-way line and on uniform line and grade.

Utility line crossings of a road will be as near a right angle (~~normal~~) to the road centerline as practicable. Where practicable, crossings should avoid deep cuts, footings of bridges and retaining walls, or locations where roadway stormwater would be affected.

Where existing facilities are in place, new facilities shall be compatible with the existing installations and shall conform to these Standards, where possible.

Gravity systems, whether sanitary sewer or stormwater drainage, shall have precedence over other systems in planning and installation except where a non-gravity system has already been installed under a previously approved permit.

Notwithstanding other provisions, underground systems shall be located at least 4 feet away from road centerline and where they will not otherwise disturb existing survey monumentation, nor interfere with the location of planned survey monumentation.

## ~~7.5~~ 7.5 Adjustment and Relocation of Existing Utilities

Existing utilities in a public right-of-way shall be removed within a ~~reasonable~~ time period specified by the County, when road work funded by the County involves disturbing an existing utility. All such removal or relocation shall be at the sole expense of the owning utility, unless otherwise specified in an approved, current franchise agreement between the utility and the County.

Aerial facilities converted to underground, at the request of the County, ~~must~~shall comply with appropriate rates approved by the Washington Utilities and Transportation Commission (WUTC).

The County's ~~6~~Six-year Transportation Improvement Plan, ~~Surface and~~ Stormwater Capital Facilities Plan and ~~Wastewater~~Sewer Utility Capital Facilities Plan ~~is~~are available to all utilities and ~~serve~~serve as the County's initial notice to utilities of planned improvements that may require utility adjustments or relocations. All utilities shall, within the limits of standard business practice, make available appropriate short or long range development plans to the County. In addition, utilities agree to participate in the planning and design of all County administered projects as defined in the Kitsap County Public Works Utilities Coordination Policy and Procedures document. All utilities are encouraged to attend the annual Utility Coordination meeting held the first quarter of each year.

Notwithstanding reinforcement or protection otherwise provided, a contractor shall be responsible for the security of each existing pipeline and other utilities within a road construction zone. Where there are unusual utility hazards or where heavy construction equipment ~~will~~shall be used, the contractor shall provide adequate temporary protection. In replacing the roadway, the design should give due consideration to the protection of previously existing utilities in the roadway section without sacrificing the geometrics of roadway design.

## ~~7.6~~ 7.6 **Underground Utility Installation**

The WSDOT Standard Specifications as well as all other applicable federal and state regulations, including health and safety standards, ~~will~~shall apply unless otherwise stated below.

A five-year moratorium on pavement excavation and trenching shall be enforced following the completion of a new road or road overlay. This requirement restricts all road trenching except in the event of an emergency repair or if all trenching is outside of the paved area.

When trenching through existing pavement, the initial pavement cut may be accomplished by jack hammering or saw cutting, all final vertical meetlines shall be sawcut and extended to at least a minimum of 2 feet outside the limits of the trench unless against an existing curb. To assure adequate compaction, all trenches shall be at least 3 feet wide unless otherwise approved by the County inspector. Trench sides shall be kept as nearly vertical as possible. Shoring shall comply with the Washington State Department of Labor and Industries Safety Standards.

Controlled Density Fill (CDF) may be required by the County in lieu of native backfill material or gravel borrow. Controlled Density Fill shall meet the requirements of WSDOT Standard Specifications.

Pipe shall be installed and the trench backfilled in a manner assuring no deformation of the pipe likely to cause leakage or degradation of the roadway structure. Compaction and restoration shall be accomplished as detailed below and immediately after the trench is backfilled, so as to cause the least disruption to traffic.

Temporary restoration of the road surface for overnight use shall be accomplished by using cold mix, controlled density fill, ~~asphalt-treated base,~~ or non-skid steel plates. Controlled density fill used for temporary restoration may be dumped directly into the trench, bladed out, and rolled. The temporary surface installation and maintenance shall be the responsibility of the applicant. After rolling, the trench ~~must~~shall be filled flush with asphalt to provide a smooth riding surface. Asphalt materials used for temporary patching ~~must~~shall be removed prior to placement of hot patch.

Gravel shoulders disturbed by excavation shall be replaced full depth with approved backfill and topped with 2 inches of crushed surfacing top course in accordance with WSDOT Standard Specifications.

Final patches shall be completed within 15 days ~~of utility installation.~~ This time frame may be adjusted at the County's discretion if delays are due to inclement paving weather, or other adverse conditions that may exist.

~~If required by the County prior to starting construction, the contractor/utility shall submit a proposed haul route for review and approval.~~ For Utility Trench Restoration and Backfill standards, see ~~Figure 7-1; Figure 7-1.~~

Plowing of communication and electrical lines on within right of way, or adjacent to existing roads by means of a vibratory plow is not allowed ~~on county roads.~~

Water settling of backfill in trenches under existing roadways is not permitted.

Above ground utilities placed within the right ~~of~~ way such as telephone and cable pedestals, vaults or any other utility equipment enclosure shall be clearly marked or maintained in such a way that all vegetation is cleared within a 5 foot radius and to a height of 12 inches above ground level. Clear zone requirements, as defined in Chapter 3.8, shall be adhered to.

## 7.6.1 Cover and Separation

**7.6.1** Underground utilities shall be constructed in compliance with applicable Federal, State and local codes and standards.

All utility installations shall be designed in accordance with the standards, codes and regulations applicable to the type of utility, including separation requirements.

## **7.6.2 Casings**

**7.6.2** Casings shall be installed for roadway crossings when required by appropriate industry codes and when directed by the County Engineer. Casing may be required for the following conditions:

- A. As an expediency in the insertion, removal, replacement, or maintenance of a carrier line crossing in locations where it is necessary in order to avoid open trench construction.

- B. As protection for carrier lines from external loads or shock either during or after construction of a road.
- C. Within the road right-of-way, where practicable, casing pipes shall extend beyond the toe of fill slopes, back of roadway ditch, or outside of curb.
- D. Other than for necessary vents and/or drains, casing pipes shall be sealed at both ends.
- E. Casing pipes shall be designed to support the load of the road and superimposed loads thereon and, as a minimum, shall equal the structural requirements for road stormwater management facilities. Casings shall be composed of materials of sufficient durability to withstand any conditions to which they may normally be exposed.

#### **7.6.2.1 Materials**

**7.6.2.1** Carrier pipes (pipes directly enclosing a transmitted fluid or gas) shall conform to the material and design requirements of the appropriate utility industry and governmental codes and specifications.

Carrier pipes shall be designed to support the load of the road plus superimposed loads thereon when the pipe is operated under all ranges of pressure from maximum internal to zero pressure.

#### **7.6.2.2 Marking**



**7.6.2.2** Location markers and emergency information shall be used when required by applicable County, State and Federal Standards.

**7.6.2.3 Identification**

**7.6.2.3** A tracer wire is required for all buried, nonconductive utilities. ~~The tracer wire shall be #12 jacketed, 45 mil solid copper and installed sufficiently near, including side services, unless~~ the utility ~~to enable electric locating of the utility line is straight with structures on each end.~~ This wire shall also be connected to existing tracer wire at the main in a manner that ensures continuity of the tracer system.

**7.6.3 Existing Roadways**

**7.6.3.1 7.6.3.1 Utility Trenches Parallel ~~To~~ Road Alignment**

**A.a)** All trench backfill within the roadway prism shall be mechanically compacted as follows:

Trench backfill within the pipe zone shall be compacted ~~to 90 percent of maximum density (modified proctor) and to 95 percent maximum density above the pipe zone,~~ in accordance with WSDOT Standard Specifications, section 2-03.3(14)C, method B.

**B.b)** All densities shall be determined by testing methods outlined in WSDOT Standard Specifications.

~~C.c)~~ All trench backfill from back of ditch to the right-of-way line shall be mechanically compacted to 85 percent of maximum density throughout the depth of the trench.

~~D.d)~~ In any trench in which the density falls below specified requirements, and further compaction cannot be achieved with existing material, the backfill shall be replaced with gravel borrow as specified in the WSDOT Standard Specifications, or with CDF, as specified in Section 7.6 of this document. Any imported backfill material shall then be mechanically compacted to the appropriate maximum density.

~~E.— Backfill compaction shall not exceed 6 inch lifts to achieve the density requirements as specified above. Such compaction shall be performed to within 6 inches of existing road grade.~~

~~F.e)~~ After placing a tack coat on the existing asphalt edges, the final patch shall be constructed with ~~Hot Mix Asphalt~~HMA to match the existing pavement thickness, or 23 inches, whichever is greater. Pavement restoration shall be a minimum of ½ lane with no paving joint in wheel tracks. The classification of HMA and asphalt binder ~~will~~shall be determined by the County Engineer.

~~G.f)~~ Any exceptions to the overlay requirement ~~will~~shall be on a case-by-case basis, subject to approval by the County Engineer, considering the existing conditions of the roadway. Portland Cement Concrete pavement shall be restored consistent with WSDOT Standard Specifications.

#### ~~7.6.3.2~~ 7.6.3.2 Utility Trenches ~~Transverse To~~Perpendicular to Road Alignment

~~A.a)~~ Utility trenching through existing pavement across the road alignment ~~will~~shall be discouraged. It ~~will~~shall not be permitted unless it can be shown that alternatives such as boring or jacking are not feasible, or unless the utility can be installed just prior to reconstruction or overlay of the road.

~~B.b)~~ \_\_\_\_\_ The entire trench shall be backfilled with gravel borrow, crushed surfacing top course, or CDF meeting the requirements of WSDOT Standard Specifications and shall be mechanically compacted to 95 percent of maximum density (modified proctor) in accordance with WSDOT Standard Specifications.

~~G.c)~~ \_\_\_\_\_ Where the same utility has previously installed utility crossings within 200 feet of a proposed crossing, a full width overlay consisting of 23 inches of ~~Hot Mix Asphalt will~~ HMA shall be required. The classification of HMA and asphalt binder ~~will~~ shall be determined by the County Engineer. In these cases, the overlay shall extend 10 feet longitudinally beyond each patch end. A pre-level may be required prior to the overlay. Pavement butt joints are required at each match line. See butt joint detail in Appendix.

D. d) \_\_\_\_\_ Where existing pavement defects are in close proximity to the new cut, the County inspector may require additional pavement removal and replacement to incorporate/eliminate the existing pavement defect and provide for a firm tie to existing pavement.

## **Untrenched 7.6.4 Trenchless Construction (Jacking, Augering or Tunneling) \_\_\_\_\_**

**7.6.4** Tunneling under pavements may be required in some situations. The developer/contractor shall install the pipe by jacking, augering or tunneling, or by installing the pipe within a casing by a combination of these methods.

Where crossing of existing utilities is a concern, windowing to expose existing utilities ~~will~~shall be allowed as conditioned within individual permits.

When use of a casing pipe is required, the developer/contractor shall be responsible to select the gauge and size required, unless otherwise indicated on the drawings, and consistent with ~~his~~this jacking or augering operation, and shall be set to line and grade. During jacking or augering operations, particular care shall be exercised to prevent caving ahead of the pipe which ~~will~~may cause voids outside the pipe. When the carrier pipe is installed within a casing pipe, the carrier pipe shall be skidded into position in \_\_\_\_\_an acceptable manner and to the line and grade as designated. The void space between the casing and the pipe shall be filled with ~~controlled density fill~~CDF or as otherwise approved by the County. The casing pipe shall be sealed, or capped at each end.

Prior to jacking or augering activities, shop drawings describing these activities, including dimensioning of pit length, size of underground borings and complete description of shoring, shall be submitted for approval.

Water boring shall not be permitted.

## **7.6.5 Testing-**

**7.6.5** Consistent with Section 7.6.3, and prior to placing any surface materials on the roadway, it shall be the responsibility of the developer to provide density tests and soil reports certified by an independent testing agency.

A minimum of one test per lift shall be taken within every 500 feet of trench length and at depths of 50 percent of trench depth and at the surface. Compaction of laterals or service line trenches shall be tested where required by the County Engineer.

Depending on the quantity of Hot Mix Asphalt used in a project, and at the discretion of the County Engineer, the applicant may be required to submit a mix design, mix design verification test results, and independent assurance samples from an independent laboratory, in accordance with the WSDOT Standard Specifications. All costs for supplying required tests ~~will~~shall be the ~~applicant's~~applicant's responsibility.

### 7.6.6 Individual Service Lines

Individual ~~Water S~~ service ~~L~~ lines shall be placed with a minimum of 36 inches cover from finished grade. Side connection shall enter perpendicular to the right-of-way within the frontage of the lot served.

~~7.6.6~~ Private ~~S~~ septic ~~T~~ tank ~~E~~ effluent ~~L~~ lines located within the right-of-way require that prior to approval, private easements shall be submitted to the Department of Public Works and recorded with the County Auditor. Following construction, record drawings of the installation shall be submitted to the Department of Public Works and recorded with the County Auditor. Effluent lines shall be placed with a minimum of 4 feet of cover from the lowest roadside feature (i.e., bottom of ditch), within 10 degrees of deflection from a perpendicular line to road centerline and extend to outside the right-of-way line. Effluent lines shall be encased in cast or ductile iron pipe of larger diameter or encased as approved by the County Engineer, for that portion of pipe within the right-of-way. Manholes should be designed and located in a manner that preserves the roadway's structure, safe operation, maintenance, and appearance and that ~~will~~ shall cause the least interference to other utilities or future roadway expansion. Installations of manholes in the pavement or shoulders should be avoided.

## ~~7.7~~ 7.7 Above Ground Utilities

Above ground utility objects, including poles, guys, transformer, and other related ground mounted equipment or facilities located within the County right-of-way shall be located to preserve a safe traffic environment, the appearance of the roadway, and the efficient and economic maintenance of the right-of-way. Where breakaway or non-stationary ground mounted utilities are to occupy the space between the traveled way and right-of-way boundary, they shall be placed as far as possible from the traveled way. Installation of bollards within right of way is not allowed.

Utility poles, guy wires, and other stationary, above-ground utility objects shall be placed outside of clear zone areas. ~~Justification for all exceptions must~~ Exceptions shall be provided to the County Engineer for review ~~and approval.~~ Installation of utility poles and other above ground utility objects ~~will~~ shall not be permitted in sidewalks or walkways, unless clear zone and ADA requirements are met and no feasible alternatives exist.

Locations of poles shall be compatible with ~~driveways~~ approaches, intersections, and other roadway features (i.e., they shall not interfere with sight distance, roadway signing, traffic signals, culverts, etc.). Where possible, utilities shall share facilities so that a minimum number of poles are needed.

The cost of relocating poles or obstacles to achieve these standards are the responsibility of the developer whose project necessitates compliance with these standards. These standards are not intended to prevent the developer from making financial arrangements to accomplish removal of a pole or appurtenance with an appropriate utility or other owner of the obstacle.

### **7.7.1 Power and Communication Lines**

Single pole construction and joint use of a pole is desirable and shall be used whenever feasible.

The minimum vertical clearance for overhead power and communication lines above the road and the minimum lateral and vertical clearance from bridges shall be in compliance with the current edition of National Electrical Safety Code and Washington State Department of Labor and Industries Electrical Construction Code.

Where irregularly shaped portions of the right-of-way extend beyond the normal right-of-way limits, a uniform alignment of facilities shall be allowed within the right-of-way.

## **7.8** 7.8 Installations on Roadway Bridges and Structures

Attachment of utility lines to a roadway structure (including bridges) may be allowed where such attachment conforms to sound engineering considerations for preserving the roadway structure and its safe operation, maintenance and appearance. The attachment shall be in accordance with the following:

- A.(1)** Attachment of a utility shall not be considered unless the structure in question is of a design that is adequate to support the additional load and can accommodate the utility facility without compromise of roadway features, including reasonable ease of maintenance.
- B.(2)** Manholes and other utility access panels shall be avoided within the roadway portion of a structure.
- C.(3)** Attachment on a structure of a pipeline carrying a hazardous substance shall be avoided where practicable.
- D.(4)** The utility attachment shall not reduce the clearance of a structure where such clearance is critical. Attachment to the outside of a structure shall be avoided where there are reasonable alternatives.
- E.(5)** Utility mountings shall be of a type that do not create noise resulting from vibration.



~~F. Any hole created in a structure abutment shall be sleeved, shall be of a minimum size necessary to accommodate the utility line, and shall be sealed to prevent any leakage of water or backfill material.~~

G.(6) The utility line at the back of the abutment shall curve or angle out to align outside the roadbed area in as short a distance as is operationally practicable.

H.(7) An evaluation by a Structural Engineer, licensed in the State of Washington, may be required.

## ~~7.9~~ 7.9 Miscellaneous Provisions

### 7.9.1 Preservation, Restoration, and Cleanup—

~~7.9.1~~ The size of disturbed area used to install a utility shall be kept to a minimum.

Restoration methods shall be in accordance with these standards and/or special provisions of the franchise, permit, agreement, or regulation.

Unsatisfactory restoration work shall be corrected by the utility within 10 business days of the date of written notification. At the direction of the County Engineer and without further notification, unsatisfactory restoration work ~~will~~may be corrected by the Public Works Department. The ~~utility company~~permit holder shall be billed for all costs incurred by the County for the execution of the restoration construction.

### 7.9.2 Traffic Control and Public Safety——

~~7.9.2~~ Traffic controls, including detours for all utility work, shall conform to Chapter 8 of these standards and the current Manual on Uniform Traffic Control Devices for Streets and Highways. A traffic control plan ~~may~~shall be required for "Right-~~of-~~way Construction Permits" that affect vehicle and/or pedestrian traffic.

## ~~7.10~~ 7.10 Final Utility Adjustment to Finish Grade

All utility covers which are located on proposed asphalt concrete pavement roadways shall be set to final elevation ~~prior to placing base material and pavement or as directed by the County after paving.~~

## ~~7.11~~ 7.11 Final Cleanup and Restoration

In addition to restoration of the roadway, as described above, the responsible utility company or other permit holder shall care for adjacent areas as follows:

~~4.(1)~~ Roadways shall be cleaned and swept both during and after each working day.

~~2.(2)~~ Disturbed soils shall be final graded, seeded, and mulched after installation of the utility. In limited areas, seeding and mulching by hand, or sod placement using approved methods, may be acceptable.

~~3.~~(3) Ditches that are lined with erodible soil and subject to rapid flows shall require seeding, jute matting, netting, placement of sod, or rock lined to control erosion.

~~4.~~(4) Any silting of downstream stormwater management facilities, whether ditches or pipe and catch basins, which results from ~~the~~ utility installation, shall be cleaned and the work area restored to a stable condition as part of the site cleanup each day.

~~5.~~(5) The repair and restoration of the right-of-way, including cleanup, ~~must~~shall be completed within the dates specified in the permit. Extensions to the completion date ~~must~~shall be approved by the County Engineer.

(6) All temporary erosion control measures shall be removed at project completion and site stabilized.

## Chapter 8

---

# Construction Control and Inspection

## 8.1 Basis for Control of the Work

### ~~8.1~~

~~A.(1)~~ Work performed in the construction or improvement of County roads, whether by or for a private developer, by County forces, or by County contractor, shall be done in accordance with these Standards and approved plans and specifications. It is emphasized that no work may be started until such plans are approved. Any revision to such plans shall be approved by the County Engineer before being implemented.

~~B.(2)~~ The County Engineer ~~will~~shall have authority to enforce ~~the~~these Standards ~~as well as other referenced within existing right of way or pertinent specifications right of way to be dedicated to the county in the future.~~ The County Engineer ~~will~~shall delegate staff engineers, assistants, and inspectors as necessary to inspect the work, and they ~~will~~shall exercise such authority as the County Engineer may delegate.

~~C.(3)~~ Provisions of the WSDOT/APWA Standard Specifications shall apply, with the term "Engineer" therein ~~construed~~ to be the County Engineer.

## ~~8.2~~ 8.2 Temporary Traffic Control

All traffic control and traffic control devices shall be as specified in the latest edition of the Manual on Uniform Traffic Control Devices (MUTCD). ~~If required by the County, the~~The Project Engineer shall submit temporary traffic control plans for review and approval.

During the progress of the work, barriers and warning signs shall be erected and maintained by the contractor as necessary or as directed by the County Engineer for the protection of the traveling public. The barriers shall be properly lighted when necessary.

### 8.2.1 Interim Traffic Control-

**8.2.1** The developer/contractor shall be responsible for interim traffic control during construction on or along traveled County roads. When road-~~or stormwater management~~ work is to be performed on County roads that are open to traffic, the developer/contractor ~~may be~~ is required to submit a traffic control plan for approval by the County Engineer prior to beginning the work. Traffic control shall follow the guidelines of the WSDOT/APWA Standard Specifications. All barricades, signs and flagging shall conform to MUTCD requirements. Signs ~~must~~ shall be legible and visible and shall be removed at the end of each work day if not applicable after construction hours.

All construction and maintenance operations shall be planned to keep interference with traffic to a minimum. ~~On heavily traveled roads, construction operations interfering with traffic shall not be scheduled during periods of peak traffic flow.~~ Work shall be planned so that closure of intersecting roads, road approaches, or other access points is held to a minimum.

Adequate provision shall be made to safeguard any open excavation, and shall include barricades, lights, flaggers, or other protective devices as may be necessary or as requested by the County Engineer.

The storage of materials on through roadways and shoulders shall not be permitted. Parking of vehicles on through roadways shall be kept to a minimum.

## **8.2.2 Temporary Road Closures and Detours—**

**8.2.2** When work restricting normal operation of a road cannot be avoided, the party doing the work ~~will~~shall accomplish the following:

~~A.~~ A. Complete an Application to Perform Work on County Road Rights-of-Way.

~~1.~~

~~2.B.~~ 2.B. Identify any restriction(s) during the pre-construction meeting, or when no pre-construction meeting is required identify restriction(s) when the application is submitted.

~~3.C.~~ 3.C. Complete a traffic control plan ~~if required by the County.~~

~~4.D.~~ 4.D. Notify the County at least 48 hours before work begins.

~~5.E.~~ 5.E. Ensure all required signs are in place before work begins.

~~6.F.~~ 6.F. Notify the County when the restriction is removed.

When temporary road closures up to 2412 hours long cannot be avoided, a traffic control and detour plan mustshall be submitted to the Department of Public Works ~~Transportation Division~~, with a permit application, a minimum of 10 days in advance of any planned closure. ~~In these cases, a~~ Approved notice signage mustshall be in place a minimum of seven (7) days prior to any closure.

In unique situations where closure of a County roadway is being considered for a continuous period exceeding 2412 hours, the proponent should contact the Department of Public Works ~~Transportation Division~~ to review the feasibility of the closure. A continuous road closure exceeding 1224 hours requires approval by the Board of County Commissioners. Providing that Public Works recommends approval of such a closure, the application package mustshall be submitted a minimum of six (6) weeks prior to implementation. In these cases, approved notice signage mustshall be in place a minimum of fourteen (14) days prior to any closure.

On major projects involving closures or significant inconvenience to road users e-motorists, the developer may be required to notify by mail, or in person, residents and businesses directly affected.



The Department of Public Works Public Information Section ~~will~~may notify the appropriate public agencies, and media outlets ~~and interested residents by mail.~~ Scheduled restrictions ~~will~~shall also be posted to The Road Report website.

### 8.2.3 Haul Routes-

~~8.2.3~~—If the construction of a proposed development is determined by the County Engineer to require special routing of large trucks or heavy construction equipment to prevent impacts on surrounding roads, residences or businesses, the developer/contractor shall be required to develop and use an approved haul route. When required, the haul route plan ~~must~~shall be prepared and submitted to the County Engineer and approved prior to beginning or continuing construction. The haul route plan shall address routing, hours of operation, signage and flagging, and daily maintenance. If the developer/contractor's traffic fails to use the designated haul route, the County Engineer may prohibit or limit further work on the development until such time as the requirements of the haul route are complied with. The County Engineer may require the developer/contractor to document the haul route pavement condition prior to initiating work. Any necessary repairs to the road or right-of-way resulting from the construction activities shall be the responsibility of the developer/contractor.

### ~~Construction Safety Zone~~—~~The construction safety zone will be determined as follows:~~8.2.4 Work Zone Clear Zone

~~8.2.4~~ ~~Work zones are divided into traffic spaces where motorists are allowed to travel, and work spaces where workers perform their work activities. Keeping~~  
~~When the posted speed is 35 MPH or under, spaces separate in work zones ensures both workers and the safety~~ motoring public are as safe as possible.

AASHTO Roadside Design Guide defines the work zone clear zone will be 10 feet (WZCZ) as:

"...the unobstructed relatively flat area impacted by construction that extends outward from the edge of the traveled way."

The WZCZ shall be established at these distances measured from the outside edge of the traveled way or 2 feet beyond the outside edge of the sidewalk.;

When the posted speed is from 40 to 55 MPH, the safety zone will be 15 feet from the outside edge of traveled way. When the posted speed is 60 MPH or over, the safety zone will be 30 feet from the outside edge of traveled way.

≤35 mph - 10 feet

40 mph – 15 feet

45-50 mph – 20 feet

The purpose of a WZCZ is to ensure the contractor's equipment, employee's private vehicles, and storage or stockpiling of project materials occur in an appropriate clear area. WZCZ criteria normally applies to hazards other than equipment and materials absolutely necessary to construction during a work shift.

During nonworking hours, equipment or materials shall not be within the ~~safety zone~~WZCZ unless it is protected by permanent guardrail or temporary concrete barrier. The use of temporary concrete barrier shall be permitted only if the County Engineer approves the installation and location.

The Contractor's nonessential vehicles and employee's private vehicles shall not be permitted to park within the WZCZ at any time unless protected as described above.

During the actual hours of work, unless protected as described above, only materials absolutely necessary to construction shall be within the ~~safety zone~~WZCZ, and only construction vehicles absolutely necessary to construction shall be allowed within the ~~safety zone~~WZCZ or allowed to stop or park on the shoulder of the roadway.

~~The Contractor's nonessential vehicles and employees private vehicles shall not be permitted to park within the safety zone at any~~

~~time unless protected as described above.~~

Deviation from the above requirements shall not occur unless the Contractor has requested the deviation in writing and the County Engineer has provided written approval.

### ~~8.3~~ 8.3 ~~Right-of-way~~ Way Construction Inspection

All road and stormwater management facility construction, proposed or in progress, which relates to right-of-way development, control and inspection ~~will~~shall be performed under the direction of the County Engineer. ~~Unless otherwise instructed by the County Engineer, the following construction activities will~~shall require a conference, monitoring or inspection:

~~A.~~ After written notification of project- plan approval, and all required permits, financial guarantees, and necessary documentation have been acquired, a preconstruction conference may be scheduled. An effort ~~will~~shall be made to schedule conferences within five working days. A conference ~~must~~shall precede the beginning of construction and include the contractor, project engineer, utilities, and other parties affected.

~~(1)~~ The County shall be notified a minimum of two ~~(2)~~ working days prior to ~~initial~~:

~~B.i.~~ Initial site work involving clearing and the installation of temporary water retention/detention and siltation control.

~~C.ii.~~ The County shall be notified a minimum of two working days prior to trenchingTrenching and placing of storm sewers and underground utilities such as sanitary sewer, stormwater drainage, water, gas, power, telephone, signals, street lighting, fiber optic, and TV lines.

~~D.iii.~~ The County shall be notified a minimum of two working days prior to anyAny backfill and compaction of storm sewers and underground utilities.

~~E.iv.~~ The County shall be notified a minimum of two working days prior whenCompletion of underground utilities, roadway grading and placement of gravel base (if required) ~~are complete.~~ Compaction tests and certifications shall be provided at the time of inspection.

~~F.v.~~ ~~The County shall be notified a minimum of two working days prior to verify~~Verify proper curb and sidewalk forming and preparation prior to placing concrete.

~~G.vi.~~ ~~The County shall be notified a minimum of two working days prior to verify~~Verify curb and sidewalk placement and finish of concrete.

~~H.vii.~~ ~~The County shall be notified a minimum of two working days prior to the~~The placement and compaction of crushed surfacing base course and top course.

~~I.~~ ~~The County shall be notified a minimum of three working days prior to any paving with asphalt concrete pavement or portland cement concrete pavement.~~

~~J.viii.~~ ~~The County shall be notified a minimum of two working days prior to final project completion. Prior to approval~~ Prior to final acceptance of construction work, acceptance for maintenance and release of construction performance bonds, the developer/contractor shall pay any required fees, submit any required maintenance and defect financial guarantees, and ~~may~~ be required to submit one ~~photo mylar or ink on mylar set of design plans and~~ two sets of final corrected plans (as-built) reflecting all minor and design plan changes of the road and stormwater management system.

~~(23)~~ The County shall be notified a minimum of ~~sixtythree~~ (3) working days prior to ~~the end of the maintenance period. any paving with asphalt concrete pavement or Portland cement concrete pavement.~~

~~K.~~ (3) Prior to release of the maintenance guarantee, there shall be successful performance during the maintenance period, correction of defects, and the payment of any outstanding fees.

~~(4) For roads designed in excess of 10% grade, developer shall provide written certification from a professional land surveyor that, after placement of gravel base the road grade is below 12%.~~

## **8.4 8.4 Penalties for Failure to Notify for Inspection**

If an applicant fails to notify the county as required by the Road Standards, Kitsap County may require sampling and/or testing post-construction, either by the Project Engineer or Kitsap County. Costs for such testing and/or sampling shall be borne by the applicant. When such testing and/or sampling is required, the County may prohibit or limit further work until all such tests and/or sampling have been completed and corrections made to the satisfaction of the County. In addition to this provision, the County reserves its right to bring any or all other enforcement action for the failure to notify.

## **8.5 Embankment Construction Control in Developments**

### **8.5**

The provisions of the WSDOT/APWA Standard Specifications apply in all respects to development construction unless otherwise instructed by the County Engineer. The following elements are mentioned for clarification and emphasis:

~~A.~~(1) Embankment and Cut Section Compaction: Compaction of the top 2 feet of fill subgrade and top 6 inches of cut subgrade shall meet a minimum 95 percent of maximum density in accordance with the WSDOT/APWA Standard Specifications. Subgrade fill below the top 2 feet shall be compacted to 90 percent of maximum density.

~~B.~~(2) Testing for Density

4.i. Prior to placing any surfacing material on the roadway, it shall be the responsibility of the developer/contractor to provide density test reports reviewed and approved by the Project Engineer. Optimum moisture content and maximum density shall be determined by methods cited in WSDOT/APWA Standard Specifications or by other test procedures approved by the County Engineer. In fill sections, a minimum of one test shall be taken for every 1,000 cubic yards or fraction thereof and on each lift of embankment. In cut sections, the interval shall be every 100 feet of roadway. For work to be accepted, tests ~~must~~shall show consistent uniform density as required by tests referenced above.

~~2~~.ii. In cases where tests do not meet the minimum standard, corrective action shall be taken, such as adding water, aerating, replacing material or applying more compactive effort as directed by the Project Engineer. Retests shall show passing densities prior to placing the next lift of subgrade fill.

~~3~~.iii. For trenching in existing roads, see [Figure 7-1](#) ~~Figure 7-1~~. [Appendix](#).

~~G~~. (3) Finishing Subgrade: After the subgrade preparation has been completed, it shall be thoroughly checked by the developer/contractor using a level, string line, crown board, or other means to determine that the subgrade conforms to the typical section or special plan conditions prior to placing any surfacing material.

## ~~8.6~~ 8.6 Asphalt Paving Control and Acceptance

For ~~Hot Mix Asphalt (HMA)~~, where paving is in the traffic lanes, including lanes for ramps, truck climbing, weaving, and speed changes, and the specified compacted course thickness is greater than 0.10 foot, the acceptable level of compaction shall be a minimum of 92 percent of the maximum density as determined by AASHTO test method T 209. The level of compaction attained ~~will~~shall be determined as the average of not less than 5 nuclear density gauge tests taken on the day the mix is placed (after completion of the finish rolling) at randomly selected locations within each lot. The quantity represented by each lot ~~will~~shall be no greater than a single day's production or approximately 400 tons, whichever is less.

Asphalt concrete pavement not meeting the prescribed minimum density standard shall be removed and replaced with satisfactory material. Cores may be used as an alternate to the nuclear density gauge tests and shall be taken within 48 hours of the placement of the mix.

At the start of paving, if requested by the County, a compaction test section shall be constructed to determine the compactibility of the mix design, ~~in accordance with section 5-04~~. Compactibility shall be based on the ability of the mix to attain the specified minimum density (92 percent of the maximum density determined by AASHTO test method T 209). Following determination of compactibility, the Contractor is responsible for the control of the compaction effort. If the County does not request a test section, the mix ~~will~~shall be considered compactable.



HMA constructed under conditions other than listed above shall be compacted on the basis of test point evaluation of the compaction train. The test point evaluation shall be performed in accordance with instructions from the County. The number of passes with an approved compaction train, required to attain the maximum test point density, shall be used on all subsequent paving.

In addition to the randomly selected locations for tests of the control lot, the County reserves the right to test any area which appears defective and to require the further compaction of areas that fall below acceptable density readings.

## ~~8.7~~ 8.7 Survey Control

All ~~existing~~ survey control monuments, including existing monuments that are disturbed, lost, ~~or destroyed~~ or removed during surveying or construction shall be replaced by a Professional Land Surveyor (PLS) licensed in the State of Washington, in accordance with WAC 332-120 and recognized good practice of land surveying. All surveyed monuments, horizontal or vertical, tied, placed, replaced or calculated shall be referenced to the coordinate system and meridian or vertical datum used. The controlling monuments used shall be specified.

Survey control monuments shall be constructed as shown on the approved construction plans, in conformance with the approved details for survey monuments. ~~The location of the monuments shall be the responsibility of a PLS, who shall scribe the brass portion of the monument after construction in accordance with recognized good practice in land surveying.~~ Survey monuments conforming with Figure 8-1 in Appendix, as approved by the County Engineer, shall be placed in County roads at:

~~(1) Survey monuments shall be required at all intersections, at the point~~ Points of curvature ~~(PC) and point~~

~~(2) Points~~ of tangent

~~(3) Intersections~~ (PT) of all curves, ~~at centers~~

~~(4) Centers~~ of cul-de-sacs, ~~and at other appropriate locations as determined necessary~~

~~(5) As needed for intervisibility~~

~~(6) As required~~ by the County Engineer. ~~Monuments at the PC and PT of the curve may be eliminated and replaced with a monument at the point of intersection, if the point of intersection~~

If a PI falls within the paved roadway surface, a PI monument may replace the corresponding PC and PT monuments. Monuments placed in landscape medians shall be marked with a sign, not more than 5 feet away, with "SURVEY MARKER Do Not Disturb." Road monuments may be offset to the paved shoulder and adequately described including offset.

~~For formal recorded documents containing a surveyor's certificate, monumentation and staking, recorded subdivisions, survey monuments shall be placed by the responsible at all exterior boundary corners and angle points. A signed and sealed statement from a registered surveyor that all monuments and corners indicated on the subdivision plat have been set and are in good condition shall be required prior to final plat approval.~~

~~A legal survey conforming to Chapter 58.09 RCW shall be filed with the County Auditor and/or the County Engineer showing methods used to establish the monument's position with references establishing the monument's location. Formal recorded documents shall contain the registered surveyor's certification. Monumentation shall be marked with the surveyor's certification number in accordance with the certificate and the Survey Recording Act Chapter 58.09 RCW.~~

## **8.8 8.8 Call Before You Dig**

Builders in accordance with the Revised Code of Washington are responsible for timely notification of utilities in advance of any construction in right-of-way or utility easements. ~~The Utility One-Call Center phone number 1-800-424-5555 should be prominently displayed on the work site.~~

## **8.9 Signal Turn On**

1. Contractor shall give the County a minimum of five (5) working days' notice prior to turn on.
2. Contractor shall contact Signal Shop two (2) days prior to turn on and review the system on site.
3. All punchlist items shall be fixed prior to turn on.
4. Turn ons shall be limited to Tues, Wed. or Thurs. from 9:00 AM to 1:00 PM (not on any government holidays).
5. Contractor will be on site with technicians able to respond to problems.
6. All detectors, striping, signs, and markings shall be in place prior to turn on, and all temporary traffic control devices removed.
7. Contractor shall respond to any signal malfunctions within the first fifteen (15) days after turn on.

|

## Chapter 9

---

### Neighborhood Traffic Calming Program

Improving traffic safety within neighborhoods is a high priority for the Department of Public Works. The Department routinely collects data on all accidents occurring on County roads and strives to improve conditions wherever possible. In areas of concern, studies may be performed to assess travel speeds, appropriate speed limits, and potential mitigation measures. In the absence of documented accidents or excessive travel speeds, neighborhood traffic calming issues can be contentious and divisive for a community. While a certain percentage of motorists disregard posted limits or drive carelessly, it's recognized that the vast majority of motorists operate their vehicles in a responsible manner. Balancing driver's desire for mobility against perceived safety issues is a challenge for countless neighborhoods. This program does not apply to federally functionally classified arterials and collectors.

#### 9.0 Objectives

The objectives of the Neighborhood Traffic Calming Program are derived from existing County policies and the mission of the Department of Public Works. They are:

- (1) Plan and design traffic calming measures and speeding countermeasures in accordance with sound engineering practices and standards.
- (2) Solicit citizen input and participation throughout all phases of neighborhood traffic safety.
- (3) Where possible to reduce the volume of vehicular traffic on residential neighborhoods, encourage motorists to use higher classification roadways.
- (4) Employ a combination of education, enforcement and engineering methods to address documented speeding issues. These methods should be used in a progressive manner with passive measures (education and enforcement) employed initially.
- (5) Work with local fire districts and law enforcement to ensure that emergency response standards are maintained.

(6) Coordinate the collection of speeding data to provide local law enforcement agencies with timely information on speeding patterns that can be utilized for enforcement efforts.

(7) Make efficient use of County resources by prioritizing traffic calming projects.

## **9.1 Eligible Roadways**

A roadway considered for traffic calming must meet each of the following eligibility requirements:

(1) A candidate road must be paved and maintained by the County, and

(2) The road must be a local access road as defined herein, and

(3) The road must have a posted speed limit of 30 mph or less, and

(4) A candidate roadway cannot have more than 2 lanes of traffic in either direction, and

(5) The roadway must have a longitudinal slope of less than 8% at all points where speed humps may be proposed.

## **9.2 Qualifying Criteria**

Candidate projects meeting the above eligibility requirements will be considered for funding provided that each of the following qualifying criteria is satisfied:

(1) 25% of the existing traffic must be travelling at least 10-mph over the posted speed limit, as determined by the County Traffic Engineer, and

(2) The average daily traffic (ADT) must be between ~~200 and 3,000~~ (200-3000 ~~—Andy~~), and

(3) At least 70% of the affected property owners (one vote per property) must support speed countermeasure installation. Affected property owners are those individuals who must use the subject roadway to get to a convenient collector or arterial roadway, or who own property

that abuts the subject road.

Projects that do not meet all of the above qualifying criteria will not be considered further.

### 9.3 Traffic Calming Measures

- (1) Calming measures are specifically employed for addressing traffic concerns in neighborhoods. Proposed measures are the result of an engineering analysis and involvement with the affected property owners. Where appropriate, countermeasures are implemented in a progressive manner with passive measures installed first and physical devices used if needed.
- (2) Passive traffic calming measures include signage, pavement markings, traffic law enforcement and public education. Installation of stop signs is not considered a traffic calming measure.
- (3) Physical devices are typically limited to speed humps. ~~but traffic circles, curb extensions/chokers or chicanes may be considered in limited applications.~~ Permanent speed radar signs are not used under this program.
- (4) Installation of physical devices requires consideration of emergency vehicle access, bus routes, commercial vehicles, road geometry, stopping sight distance, drainage, pavement condition, bicycle/pedestrian usage, the condition of surrounding roadways and cost.

### 9.4 Neighborhood Traffic Calming Process

Neighborhood traffic calming improvements are initiated by the Department of Public Works, or, are requested by affected property owners. The initial request must include a petition signed by at least 25% of affected property owners (one signature per property). The Traffic Division will perform an engineering study to determine if eligibility requirements and qualifying criteria have been met. The Sheriff's Department, fire services, transit and schools will be consulted as applicable. The affected property owners will be notified of the engineering study findings.

If Eligibility Requirements and Qualifying Criteria are Satisfied:

- (1) The Traffic Division will develop a conceptual plan and communicate this information to the affected property owners.
  - (2) Information regarding proposed neighborhood traffic calming measures will be provided to affected property owners by mail. If significant concerns exist with the affected property owners, either Public Works or affected property owners may request a public meeting to discuss issues and/or modify the plan accordingly.
  - (3) Following the distribution of information on proposed traffic calming measures, the Department of Public Works will send out voting ballots to affected property owners. Each property will receive one vote. If at least 70% of affected property owners are in favor of the proposal, traffic calming measures will be installed. If not, no additional action will be taken.
  - (4) If more than 30% of affected property owners reject proposed traffic calming measures, or more than 70% of affected property owners fail to respond, another petition may not be considered for 3 years unless documented speeds or ADT increase significantly.
  - (5) Affected property owners will be notified by mail of the vote outcome and proposed actions, if any.
  - (6) Where the above provisions are satisfied, neighborhood traffic calming measures installed will be either constructed by the Department of Public Works or contracted. Projects will be constructed subject to available funding and competing demands of higher priority.
- If neither the eligibility nor qualifying criteria are met, another petition will not be considered for 3 years unless speeds or ADT increases significantly.



## Chapter 10

---

# Permits and Standards for Use and Improvements to County Right of Way

## 10.1 Authority and Purpose

It is the purpose of this chapter to establish a permit process and standards for regulating the opening, improvements and use of county rights of way by persons, firms or entities requiring use of and access to the County right of way for road and drainage purposes. Improvements and use of County right of way that is opened, within maintained or unmaintained areas is permitted by standards outlined in Chapter 7.

Permits issued pursuant to this chapter do not convey any vested right or ownership interest in any County right of way. Each permit shall state on its face that any County right of way improved pursuant to this chapter shall be open for use by the public except in those cases where specific conditions in a temporary use permit restrict the use of the right of way for safety reasons.

## 10.2 Permit Required

Any improvements, alterations, utility installation or expansion, logging, and drainage activities requires a Permit to Perform Work in County right of way issued by the Department of Public Works No unopened County right of way or unmaintained road within a county right of way shall be privately improved, altered, expanded upon or used for access or utilities purposes, nor shall development approval necessitating such improvements or use be granted, unless a permit has been issued pursuant to this chapter.

Right of way use approvals issued prior to the effective date of the ordinance codified in this chapter shall remain in effect. However, subsequent additional uses or improvements to said right of way shall comply with the provisions of this chapter.

The County Engineer may issue a permit to the applicant upon filing of a complete application, payment of fees, posting of any required financial sureties, recording of covenants and dedication of additional right of way, if required. Issuance of a permit authorizes the construction of road and drainage improvements and use of the county right of way only for the purposes identified in the permit.

### 10.3 Permit Type and Requirements

The permit type and requirements shall be as specified within one of the following categories:

#### (1) Category 1 Right of Way Use Permit

A Category 1 permit shall be required for use of and improvements to unopened county right of way or unmaintained road within county right of way when the applicant desires the County to assume maintenance responsibilities for the road and drainage improvements to be constructed or when such improvements are required in connection with other development approvals.

- i. Required Improvements: A Category 1 permit shall specify the minimum improvements required by the County Engineer. The road dimensions and design shall be in accordance with the Road Standards. The road shall be constructed from the point of connection with a county-maintained road to and across the applicant's property frontage. The storm drainage requirements shall be in accordance with the Kitsap County Storm Water Management Ordinance (Kitsap County Code Chapters 12.04 – 12.32), as it now exists or is hereafter amended. Construction of required improvements shall be completed by the applicant prior to issuance of a building permit. All Construction work and restoration work required by the permit shall be completed within one year of the permit's issuance.

In addition, conditions may be imposed to assure compliance of the permit with other county adopted plans, policies, standards and regulations. The applicant shall be responsible for proper notice to the County requesting the necessary inspections and final approval. The applicant shall assume sole responsibility for the safe and adequate operation and maintenance of any improvements within or adjacent to the county right of way during the time the permit is in effect. If road name is nonexistent, a road name shall be applied for through the addressing division in the Kitsap County Department of Community Development for approval.

- ii. Survey: When considered necessary by the County Engineer to adequately define the limits of the right of way, the applicant shall be responsible for the survey of the right of way by a Washington State licensed Professional Land Surveyor at the applicant's cost.
- iii. Right of way Dedication: The applicant may be required to deed additional right of way across property under his/her ownership when necessary to fulfill the minimum road right of way width prescribed by the road standards.
- iv. Notification to Adjacent Property Owners Required: The department shall obtain verification via certified mail receipts that all owners of the property abutting on each side of that portion of the right of way that has been requested for use or improvement have been contacted. Objections made by abutting property owners shall be resolved by the applicant to the maximum extent practical to the satisfaction of the department prior to the issuance of the permit.
- v. Maintenance Bond. Prior to the final approval of construction, a maintenance bond or other acceptable surety must be posted and maintained by the applicant for a period of two years (See Section 7.2.1).

## 10.4 Reimbursement by Other Property Owners

When

ORDINANCE NO. \_\_\_\_\_

**~~AMENDING KITSAP COUNTY ROAD STANDARDS ORDINANCE~~**

~~AN ORDINANCE amending Kitsap County Code Chapter 11.22 regarding the Kitsap County Road Standards 293-2003~~

~~WHEREAS, an expanding population and increased land development can lead to inadequate transportation infrastructure creating traffic safety, capacity and non-motorized use problems; and~~

~~WHEREAS, these problems may result in risk to human life, damage to private and public properties, delays in travel and impacts to economic development; and~~

~~WHEREAS, future transportation related problems could be reduced if land developers, public and private, provide adequate transportation infrastructure; and~~

~~WHEREAS, establishing minimum standards for design and construction of county roads is necessary to assure compliance and consistency with accepted and adopted standards; and~~

~~WHEREAS, RCW 36.75.040(4) provides that the Board of County Commissioners has the power and duty to perform all necessary acts necessary and proper for the administration of the county roads as by law provided; and~~

~~WHEREAS, RCW 36.80.030 and RCW 36.75.050 provide that the County Engineer has the authority for preparing standards for construction of roads and bridges; and~~

~~WHEREAS, the Board of County Commissioners finds a need to update the County Road Standards and that it is in the public welfare so to do.~~

~~NOW, THEREFORE, BE IT ORDAINED BY THE KITSAP COUNTY BOARD OF COMMISSIONERS:~~

|

#

#

|

## ~~KITSAP COUNTY ROAD STANDARDS ORDINANCE~~

~~Section 1. Kitsap County Code Section 11.22.020, adopted by Ordinance 293-2003, is amended as follows:~~

### ~~11.22.020 — AUTHORITY AND INTENT~~

~~Chapter 36.75 RCW requires that county roads be established, laid out, constructed, altered, repaired, improved, and maintained by the county or by private individuals or entities authorized to perform such work under an agreement with the county legislative authority. Such work and improvements shall be done in accordance with adopted county standards under the supervision and direction of the County Engineer (hereafter the "Road Standards").~~ an applicant makes road improvements in accordance with a Category 1 Right of Way Use Permit, and adjacent property owners benefit from the improvements, the applicant may enter into a reimbursement agreement with the County to recoup a pro rata share of the costs of the improvements, in accordance with Chapter 35.72 RCW, from adjacent property owners subsequently allowed to use the improvements.

#### (1) Category 2 Right of Way Use Permit

A Category 2 permit shall be required for use of and improvements to an unopened county right of way when the maintenance responsibilities for the improvements will rest with the applicant and all abutting property owners using the improvements.

- i. Required Improvements: A Category 2 permit shall specify the minimum improvements required by the County Engineer. The road dimensions and design shall be in accordance with the *Road Standards*. At a minimum, the applicant will be required to construct half a road on the applicant's side of the right of way. The road will be constructed from the point of connection to a County maintained road or a road constructed under a previous permit, to and across the applicant's property frontage. Subsequent permits issued for the same right of way will require that improvements be made that further improve the road to accommodate the ultimate average daily traffic volume. The storm drainage requirements shall be in accordance with Kitsap County Storm Water Management Ordinance (Kitsap County Code Chapters 12.04 – 12.32), as it now exists or is hereafter amended. Construction of required improvements shall be completed and accepted by the applicant prior to issuance of a building permit. Construction work and all restoration work required by the permit shall be completed within one year of the permit's issuance.

- ii. Covenant: The applicant will be required to complete, sign, and record a covenant as a condition of approval for a Category 2 permit; the covenant document will be prepared by County staff. This covenant will be legally binding and run with the land.

The covenant does not replace or imply the existence of a formal road maintenance agreement. The covenant shall be filed and recorded with the Kitsap County Auditor prior to permit issuance. The covenant shall contain the following:

A statement that the property owner, in consideration of the County's approval to permit use of or improvements to a County right of way, agrees to waive the right to protest the formation of a road improvement district (CRID) pursuant to RCW Chapter 36.88. The road improvement district, if formed, would finance the design and construction of the road meeting the requirements of the Road Standards. This condition does not waive the property owner's right to object to their individual assessment or to appeal to the superior court the decision of the County Commissioners affirming the final assessment roll.

A statement that access to the applicant's property is across an unmaintained road, that the County is not responsible for maintenance of the road and the applicant acknowledges a joint responsibility with other property owners accessing the right of way for the maintenance and improvements made thereon. Maintenance responsibilities shall include , but are not limited to, maintenance of the road and shoulder surfacing, signs, storm drainage facilities and vegetation control.

A statement that the covenant is binding on the successors and assigns of the property owner.

iii. Survey: When considered necessary by the County Engineer to adequately define the limits of the right of way, the applicant shall be responsible for the survey of the right of way by a Washington State licensed Professional Land Surveyor at the applicant's cost.

iv. Right of way Dedication: The applicant may be required to deed additional right of way across property under his/her ownership when necessary to fulfill the minimum road right of way width prescribed by said road standards for the road functional classification as identified in the permit.

v. Notification to Adjacent Property Owners Required: The department shall obtain verification via certified mail receipts that all abutting property owners on that portion of the right of way requested for use or improvement have been contacted by the proponent. Objections made by abutting property owners shall be resolved by the applicant to the maximum extent practical prior to the issuance of the permit.

### (3) Category 3 Right of way Use Permit

A Category 3 permit shall be required when a single family property owner is requesting permanent use and access to an existing unmaintained road in a County right of way. This

permit applies to unmaintained roads constructed prior to the effective date of this chapter or unmaintained roads constructed under a Category 2 permit wherein the road abuts the applicant's property. The maintenance responsibilities for the road rest with the applicant and all abutting property owners having access to the road.

- i. Required Improvements: The Category 3 use permit is also referred to as a Road Approach Permit and shall incorporate the requirements of a road approach permit issued pursuant to Chapter 4 of these road standards. A Category 3 permit must be obtained by the applicant prior to the issuance of a building permit.
  
- ii. Application: The permit application shall be the same as that used for a road approach permit issued pursuant to Kitsap County Code Chapter 11.24 and shall also include the covenant required under this chapter. Application fees will be paid per Kitsap County Resolution No. 042-2018.
  
- iii. Covenant: The applicant will be required to complete, sign, and record a covenant as a condition and approval of a Category 2 permit; the covenant document will be prepared by county staff. This covenant will be legally binding and run with the land. The covenant does not replace or imply the existence of a formal road maintenance agreement. The covenant shall contain a statement regarding the purpose of access to the applicant's property. The The covenant shall be filed and recorded with the Kitsap County Auditor prior to permit issuance.

The covenant shall contain the following language:

A statement that the property owner, in consideration of the County's approval to permit use of or improvements to a County right of way, agrees to waive the right to protest the formation of a road improvement district (CRID) pursuant to RCW Chapter 36.88. The road improvement district, if formed, would finance the design and construction of the road meeting the requirements of the Road Standards. This condition does not waive the property owner's right to object to their individual assessment or to appeal to the superior court the decision of the County Commissioners affirming the final assessment roll.

A statement that access to the applicant's property is across an unmaintained road, that the County is not responsible for maintenance of the road and the applicant acknowledges a joint responsibility with other property owners accessing the right of way for the maintenance and improvements made thereon. Maintenance responsibilities shall include , but are not limited to, maintenance of the road and shoulder surfacing, signs, storm drainage facilities and vegetation control.

A statement that the covenant is binding on the successors and assigns of the property owner.

#### (4) Category 4 Right of way Use Permit



A Category 4 permit shall be required when temporary use of public right of way is desired. Temporary use shall include all uses not intended to last longer than one year in duration. The permit will specify minimum improvements required by the County. At a minimum, the permit will address road construction, safety, erosion control, drainage and right of way restoration requirements. In addition, conditions may be imposed to assure compliance with other adopted County plans, policies, standards and regulations. Upon termination of the use of the right of way, the applicant shall be required to abandon and restore the right of way and designated under the permit conditions. A surety may be required to insure proper restoration.

#### (5) Category 5 Right of Way Use Permit

A Category 5 right of way use permit shall be required for use of and improvements to an unopened County right of way or unmaintained road for the specific purpose of providing bike/pedestrian/equestrian access for trail purposes. The Category 5 permit is limited to non-profits, organized community clubs, groups and organizations. Upon the completion of trail improvements approved under a Category 5 permit the maintenance responsibilities for the trail rest with the applicant(s).

- i. Required Improvements: Improvements will consist of the construction of soft-surface trail improvements limited generally to the removal of brush and vegetation and generally avoiding tree removal. Removal of trees larger than four inches in diameter will require approval of the department during the permitting process and prior to actual trail construction. In addition, conditions may be imposed to assure compliance of the permit with other County adopted plans, policies, standards and regulations. Construction of the required improvements shall be completed and approved by the County Engineer prior to final approval. The applicant shall be responsible for proper notice to the County Engineer requesting the necessary inspections and approval. The applicant shall assume sole responsibility for the safe and adequate operation and maintenance of any improvements within the County right of way.
- ii. Construction Impacts: Construction of trails shall always be approached from a low impact, multi-use point of view. Trails shall be placed to minimize impacts to vegetation and adjacent properties and improve safety.
- iii. Survey: Prior to construction of the trail, Kitsap County will provide survey centerline markings to ensure proper placement of the trail improvements near or on the edge of the right of way.
- iv. Notification to Adjacent Property Owners Required: The department shall obtain verification via certified mail receipts that all owners of the property abutting on each side of that portion of the right of way that has been requested for use or improvement have been contacted. Objections made by abutting property owners shall be resolved by the applicant to the maximum extent practical prior to the issuance of the permit.

- v. Future Vehicular Access: A Category 5 permit does not preclude future development of the right of way. Future development of the right of way must include consideration of non-motorized transportation and public access. If the County finds it necessary to utilize the right of way for any future purpose, the applicant shall not be reimbursed for the removal of any improvements or other costs incurred by the applicant.
- vi. Signs: Kitsap County shall supply, maintain, and pay for all required signs identified by the County Engineer. A sign shall be posted which states that "Trail Not Maintained by the County."
- vii. Preliminary Approval: Prior to making improvements the applicant shall receive a permit from Kitsap County authorizing said improvements.
- viii. Final Approval: The final approval shall be issued by the department upon inspection and completion of the construction of the required improvements. The County Engineer shall make the appropriate notice upon official County right of way records.
- ix. Application Permit Fees: For the purposes of this Category 5 permit, Kitsap County shall have the discretion to waive fees associated with this application. Partnerships between communities and the County enhance cooperation in the realization of bike/pedestrian/equestrian systems at minimal expense to the community and the general public.

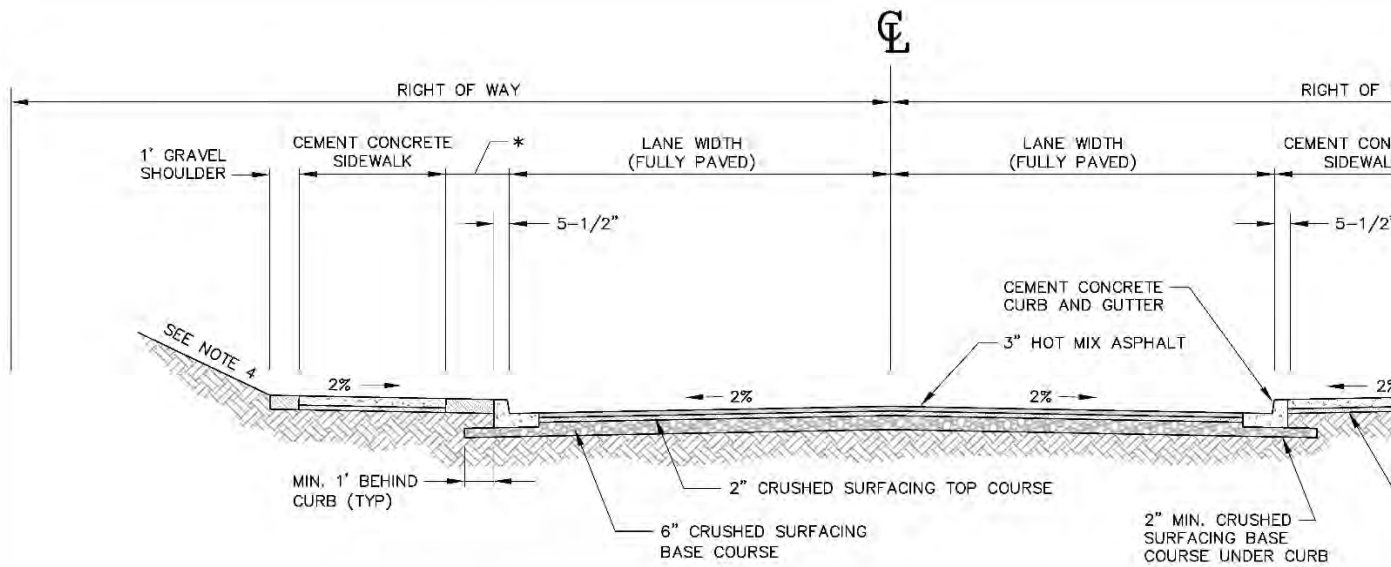

## TYPICAL URBAN ROADWAY SECTION

NTS

### NOTES:

1. SURFACING DEPTHS SHOWN ARE MINIMUMS FOR ARTERIAL ROADS AND SHALL BE DESIGNED WITH A STRUCTURAL SECTION TAKES INTO ACCOUNT THE LOAD BEARING CAPACITY OF THE SOILS AND THE TRAFFIC CARRYING REQUIREMENTS OF THE ROADWAY. PLANS SHALL BE ACCOMPANIED BY THE SOILS AND TRAFFIC ANALYSIS ON WHICH THE DESIGN IS BASED.
  2. WHEN NATIVE SUBGRADE MATERIAL MEETS THE SPECIFICATIONS FOR CRUSHED SURFACING BASE COURSE, THE 6" CRUSHED SURFACING BASE COURSE CAN BE ELIMINATED OR SUBSTITUTED WITH A LESSER THICKNESS OF CRUSHED SURFACING BASE COURSE OR EQUIVALENT MATERIAL.
  3. CURBED SECTION SHALL BE USED IN ALL URBAN AREAS UNLESS A DEVIATION IS APPROVED.
  4. SIDE SLOPES SHALL BE CONSTRUCTED NO STEEPER THAN 2H:1V FOR LOCAL ROADS AND 3H:1V FOR CUT SLOPES AND FOR FILL SLOPES ON ARTERIALS UNLESS A TRAFFIC BARRIER OR ADEQUATE JUSTIFICATION IS PROVIDED.
  5. RIGHT OF WAY WIDTHS SHALL BE INCREASED AS NECESSARY TO ACCOMMODATE ADDITIONAL LANES.
  6. SEE WSDOT/APWA STANDARD SPECIFICATION FOR VERTICAL CURB, GUTTER, AND SIDEWALK CRITERIA.
  7. SIDEWALK WIDTH AND LOCATION SHALL MATCH EXISTING CONDITIONS AND/OR COMPLY WITH CURRENT AREA PLANNING DOCUMENTS AND CONDITIONS OF DEVELOPMENT APPROVAL.
- \* PLANTER STRIP AS REQUIRED.



**KITSAP COUNTY**  
DEPARTMENT OF PUBLIC WORKS



## TYPICAL URBAN ROADWAY SECTION

CEMENT CONCRETE BARRIER CURB, GUTTER, AND SIDEWALK

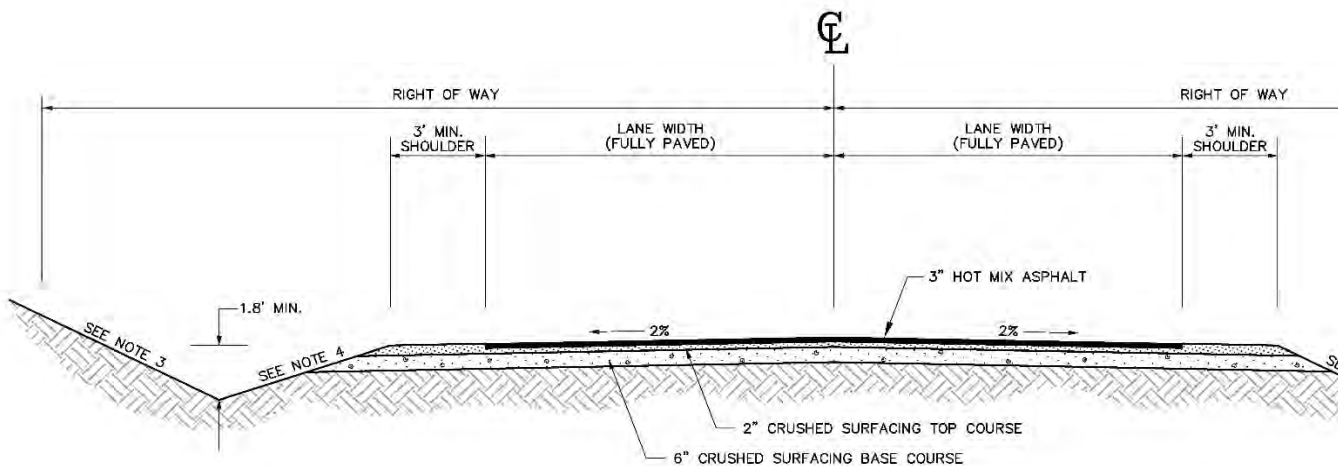

## TYPICAL RURAL ROADWAY SECTION

NTS

**NOTES:**

1. SURFACING DEPTHS SHOWN ARE MINIMUMS FOR ARTERIAL ROADS AND SHALL BE DESIGNED WITH A STRUCTURAL SECTION THAT TAKES INTO ACCOUNT THE LOAD BEARING CAPACITY OF THE SOILS AND THE TRAFFIC CARRYING REQUIREMENTS OF THE ROADWAY. PLANS SHALL BE ACCOMPANIED BY THE SOILS AND TRAFFIC ANALYSIS ON WHICH THE DESIGN IS BASED.
2. WHEN NATIVE SUBGRADE MATERIAL MEETS THE SPECIFICATIONS FOR CRUSHED SURFACING BASE COURSE, THE 6" CRUSHED SURFACING BASE COURSE CAN BE ELIMINATED OR SUBSTITUTED WITH A LESSER THICKNESS OF CRUSHED SURFACING BASE COURSE OR EQUIVALENT MATERIAL.
3. SIDE SLOPES SHALL BE CONSTRUCTED NO STEEPER THAN 2H:1V FOR LOCAL ROADS AND 3H:1V FOR CUT SLOPES AND 4H:1V FOR FILL SLOPES ON ARTERIALS UNLESS A TRAFFIC BARRIER OR ADEQUATE JUSTIFICATION IS PROVIDED.
4. DITCH (IN-SLOPE) SHALL NOT EXCEED 4H:1V FOR ARTERIALS AND 2H:1V FOR LOCAL ROADS.
5. RIGHT OF WAY WIDTHS SHALL BE INCREASED AS NECESSARY TO ACCOMMODATE ADDITIONAL LANES.



**KITSAP COUNTY**  
DEPARTMENT OF PUBLIC WORKS



## TYPICAL RURAL ROADWAY SECTION

GRAVEL SHOULDERS AND OPEN DRAINAGE

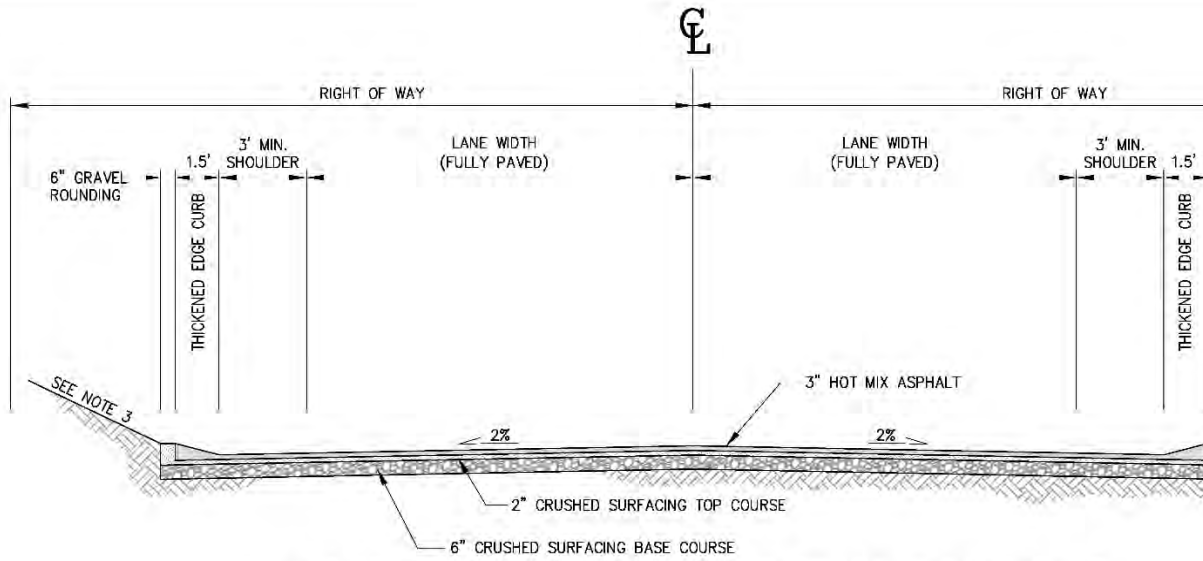

## TYPICAL RURAL ROADWAY SECTION

SEE SECTION 3.7  
NTS

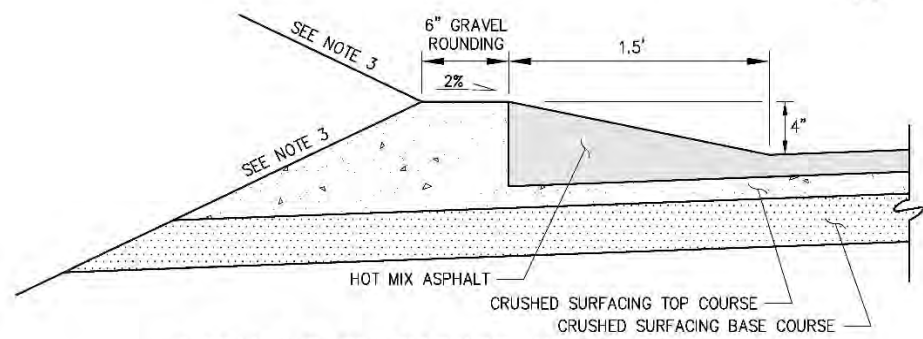

## ASPHALT THICKENED EDGE DETAIL

NTS

### NOTES:

1. SURFACING DEPTHS SHOWN ARE MINIMUM. DESIGN WITH A STRUCTURAL SECTION BEARING CAPACITY OF THE SOILS AND ROADWAY. PLANS SHALL BE ACCOMPANIED BY A GEOTECHNICAL REPORT WHICH THE DESIGN IS BASED.
2. WHEN NATIVE SUBGRADE MATERIAL MEETS THE REQUIREMENTS OF SECTION 3.7, THE 6" CRUSHED SURFACING BASE COURSE, THE 6" CRUSHED SURFACING TOP COURSE, OR EQUIVALENT MATERIAL MAY BE ELIMINATED OR SUBSTITUTED WITH A LOCAL MATERIAL.
3. SIDE SLOPES SHALL BE CONSTRUCTED TO A MINIMUM OF 3H:1V FOR CUT SLOPES AND 4H:1V FOR FILL SLOPES UNLESS OTHERWISE SPECIFIED BY THE TRAFFIC BARRIER OR ADEQUATE JUSTIFICATION.
4. FUNCTIONAL CLASSIFICATION AND EXISTING ROADWAY CONDITIONS SHALL BE DETERMINED BY THE TRANSPORTATION DIVISION.
5. RIGHT OF WAY WIDTHS SHALL BE INCREASED TO ACCOMMODATE ADDITIONAL LANES.



**KITSAP COUNTY**  
DEPARTMENT OF PUBLIC WORKS



## TYPICAL RURAL ROADWAY SECTION

THICKENED EDGE CURB



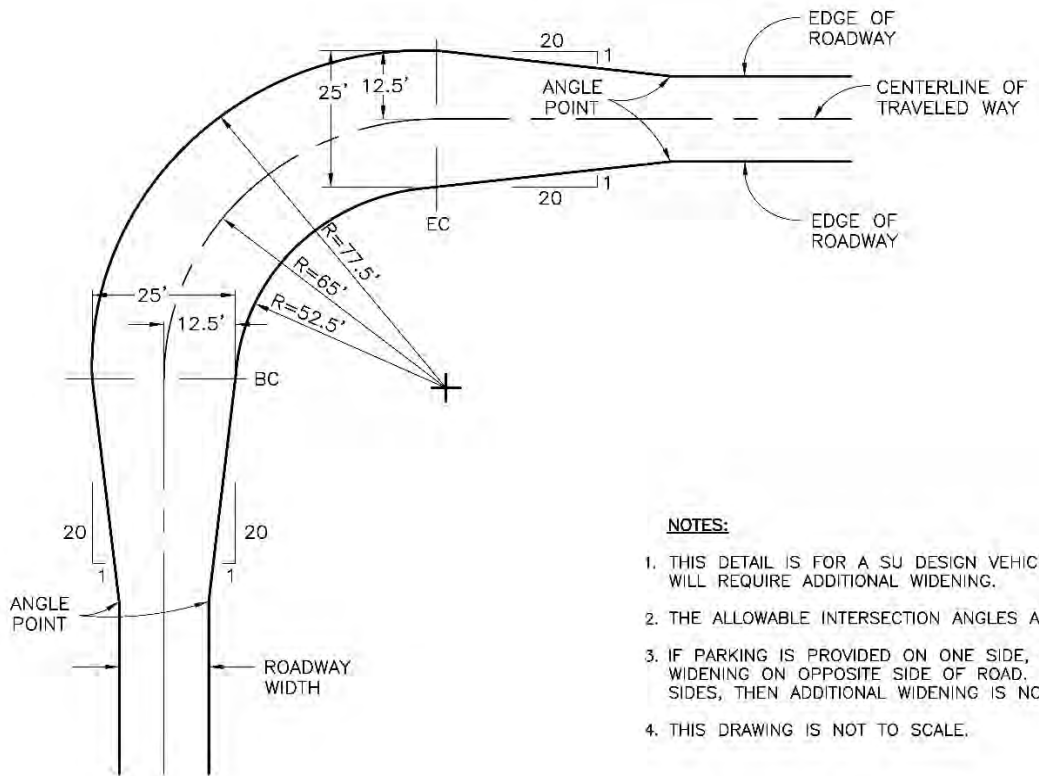

**NOTES:**

1. THIS DETAIL IS FOR A SU DESIGN VEHICLE ONLY. LARGER VEHICLES WILL REQUIRE ADDITIONAL WIDENING.
2. THE ALLOWABLE INTERSECTION ANGLES ARE 75 TO 105 DEGREES.
3. IF PARKING IS PROVIDED ON ONE SIDE, THEN ONLY NEED WIDENING ON OPPOSITE SIDE OF ROAD. IF PARKING IS PROVIDED ON BOTH SIDES, THEN ADDITIONAL WIDENING IS NOT NECESSARY.
4. THIS DRAWING IS NOT TO SCALE.



**KITSAP COUNTY**  
DEPARTMENT OF PUBLIC WORKS



**STANDARD DETAIL**

"L" INTERSECTION – VERY LOW VOLUME LOCAL ROAD

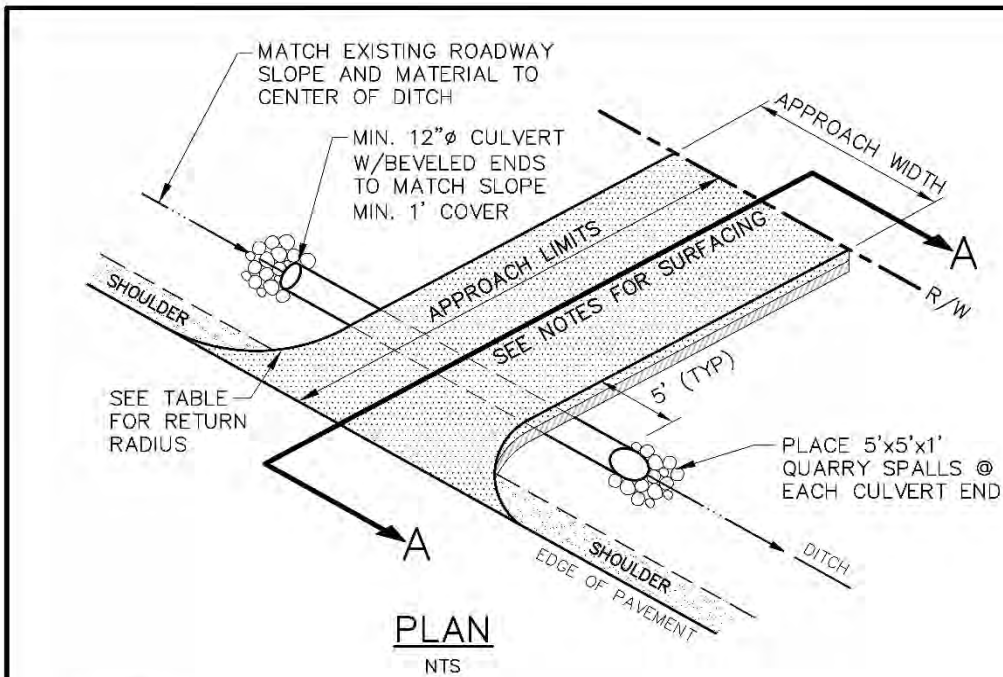

**NOTES:**

1. APPROACH PAVING = MINIMUM 2" COMPACTED DEPTH HOT MIX ASPHALT, OVER MINIMUM 2" COMPACTED DEPTH CRUSHED SURFACING TOP COURSE, OR MINIMUM 6" CEMENT CONCRETE CLASS 4000.
2. ALL PORTLAND CEMENT CONCRETE APPROACHES REQUIRE AN INSPECTION OF THE FORMS AND EXPANSION JOINT LOCATIONS PRIOR TO CONCRETE INSTALLATION.
3. APPROACH SHALL NORMALLY BE AT 90 DEGREES TO ROAD CENTERLINE, BUT CAN VARY FROM 75 TO 105 DEGREES.
4. CULVERT PIPE MUST BE CONCRETE, CMP, OR CPEP WITH QUARRY SPALLS. MINIMUM LENGTH IS 20' OR DETERMINED BY WIDTH OF APPROACH PLUS 5' EACH END (EXCLUDING BEVELED END SECTIONS).
5. IF EXISTING COUNTY ROAD SURFACE IS OTHER THAN ASPHALT CONCRETE PAVEMENT, A LIKE MATERIAL MAY BE USED ON ROAD APPROACH.

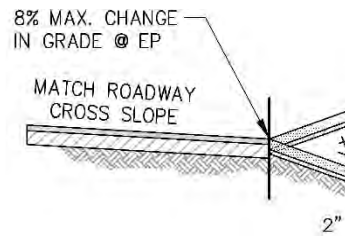

**SECTION A**  
NTS



**KITSAP COUNTY**  
DEPARTMENT OF PUBLIC WORKS



**STANDARD DETAIL**

RURAL RESIDENTIAL / MAJOR APPROACH

RET  
RESIDENTIAL APP  
RESIDENTIAL APP  
RESIDENTIAL APP  
RESIDENTIAL APP  
RESIDENTIAL APP  
MAJOR APPROACH

APPE  
RESIDEN  
MAJOR

	"A"	"B"	"C"	"D"
RESIDENTIAL	10' MIN.	15' MIN.	5' MAX.	2.50'

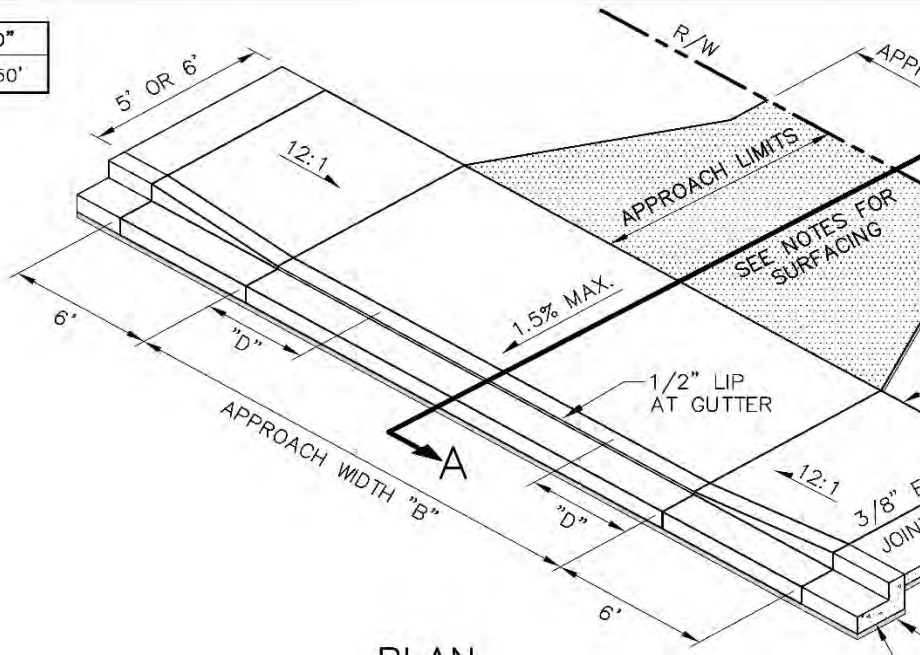

**PLAN**

NTS

CEMENT CONCRETE CURB AND GUTTER (SEE WSDOT STANDARD PLANS FOR DETAILS)

**NOTES:**

1. APPROACH PAVING = MINIMUM 3" COMPACTED DEPTH HOT MIX ASPHALT, OVER MINIMUM 2" COMPACTED DEPTH CRUSHED SURFACING TOP COURSE, OR MINIMUM 6" CEMENT CONCRETE CLASS 4000.
2. ALL PORTLAND CEMENT CONCRETE APPROACHES REQUIRE AN INSPECTION OF THE FORMS AND EXPANSION JOINT LOCATIONS PRIOR TO CONCRETE INSTALLATION.
3. MAINTAIN 1/2" LIP AT GUTTER.
4. APPROACH SHALL NORMALLY BE AT 90 DEGREES TO ROAD CENTERLINE, BUT CAN VARY FROM 75 TO 105 DEGREES.
5. WHEN SIDEWALK IS ADJACENT TO A ROADWAY, THEN THE SLOPE IS ALLOWED TO MATCH THE PROFILE OF THE ROAD.
6. REFER TO CURRENT WSDOT STANDARDS FOR SPECIFIC WHEELCHAIR RAMP REQUIREMENTS.

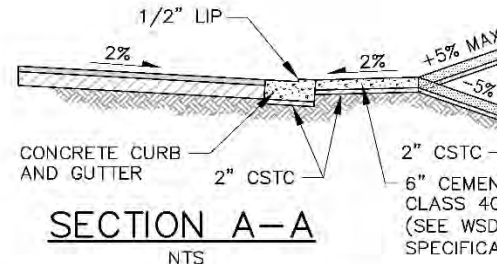

**SECTION A-A**

NTS

2" CSTC -  
6" CEMENT  
CLASS 40  
(SEE WSD  
SPECIFICA



**KITSAP COUNTY**  
DEPARTMENT OF PUBLIC WORKS



**STANDARD DETAIL**

URBAN RESIDENTIAL APPROACH



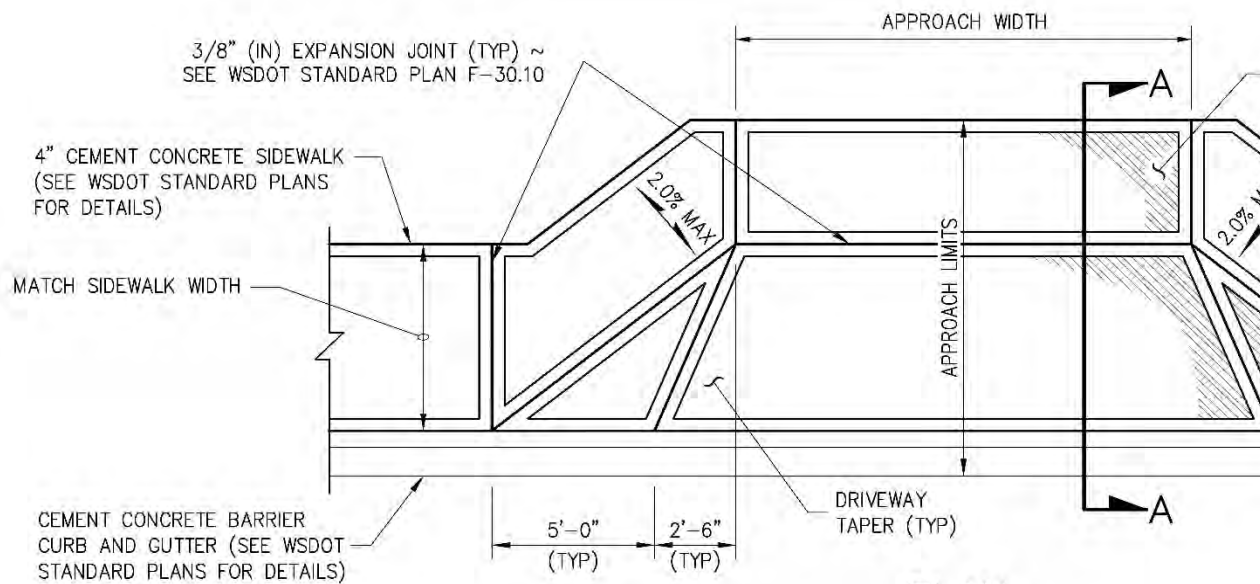

**PLAN**  
NTS

**NOTES:**

1. APPROACH WIDTH = 20' MIN. AND 36' MAX.
2. APPROACH SHALL NORMALLY BE AT 90 DEGREES TO ROAD CENTERLINE, BUT CAN VARY FROM 75 TO 105 DEGREES.
3. REFER TO CURRENT WSDOT STANDARDS FOR SPECIFIC WHEELCHAIR RAMP REQUIREMENTS.

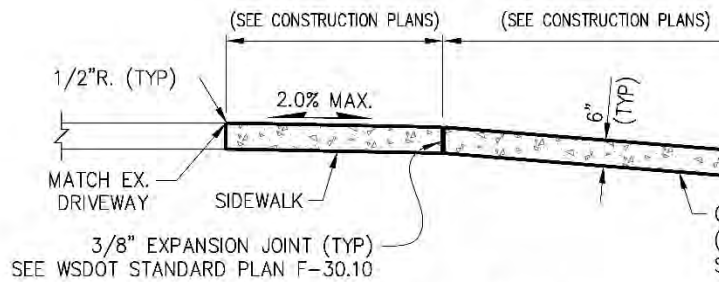

**SECTION A-A**  
NTS



**KITSAP COUNTY**  
DEPARTMENT OF PUBLIC WORKS



**STANDARD DETAIL**

URBAN MAJOR APPROACH

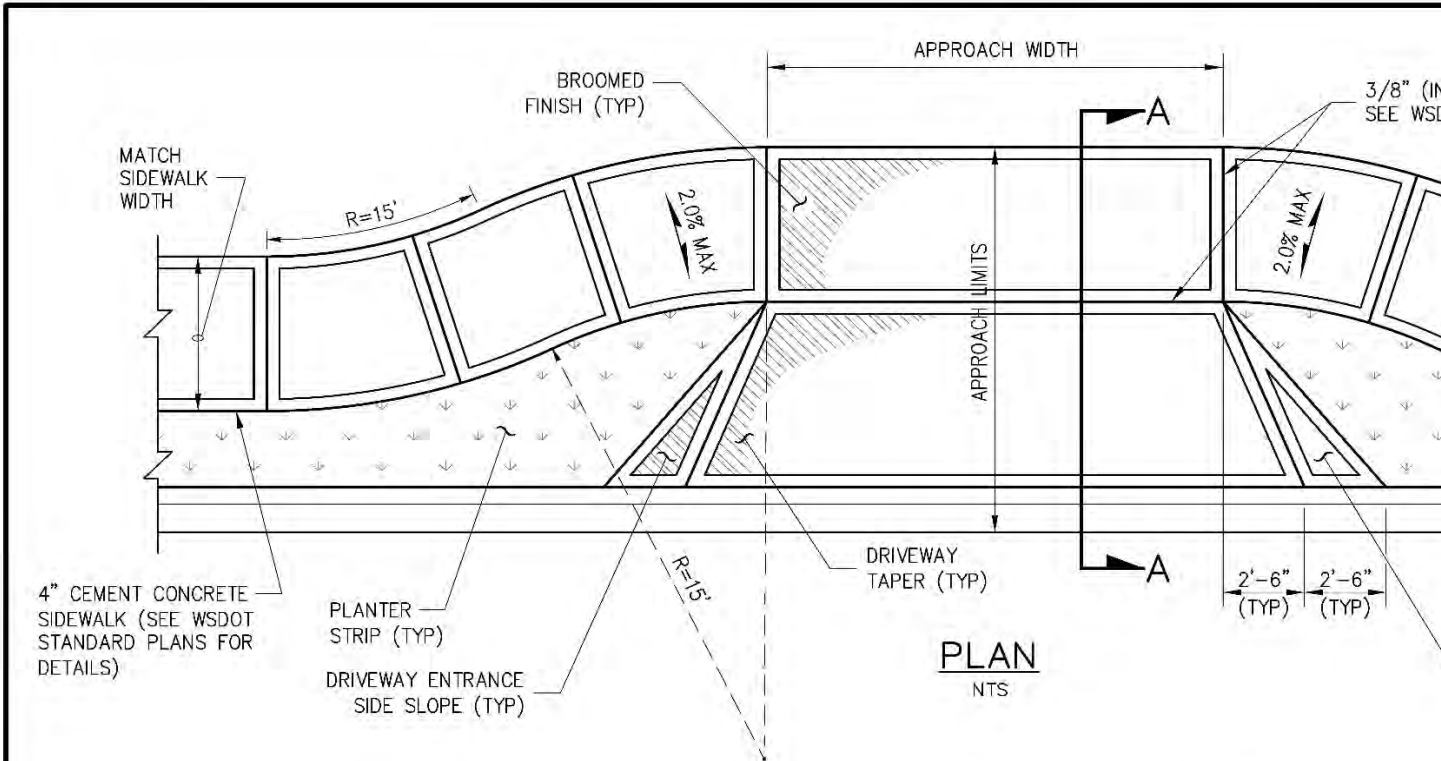

**NOTES:**

1. APPROACH WIDTH = 20' MIN. AND 36' MAX.
2. APPROACH SHALL NORMALLY BE AT 90 DEGREES TO ROAD CENTERLINE, BUT CAN VARY FROM 75 TO 105 DEGREES.
3. REFER TO CURRENT WSDOT STANDARDS FOR SPECIFIC WHEELCHAIR RAMP REQUIREMENTS.

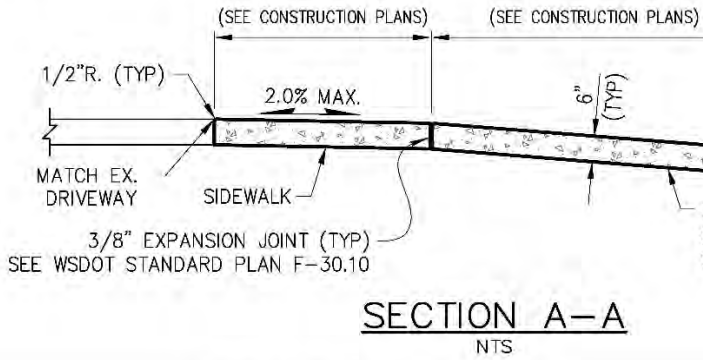

**KITSAP COUNTY**  
DEPARTMENT OF PUBLIC WORKS



**STANDARD DETAIL**

URBAN MAJOR APPROACH – PLANTER STRIP

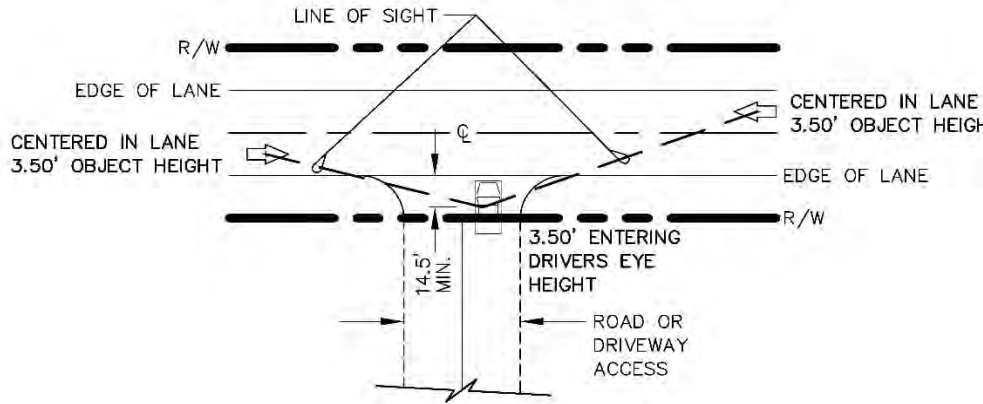

**SIGHT DISTANCE DETAIL**

NTS

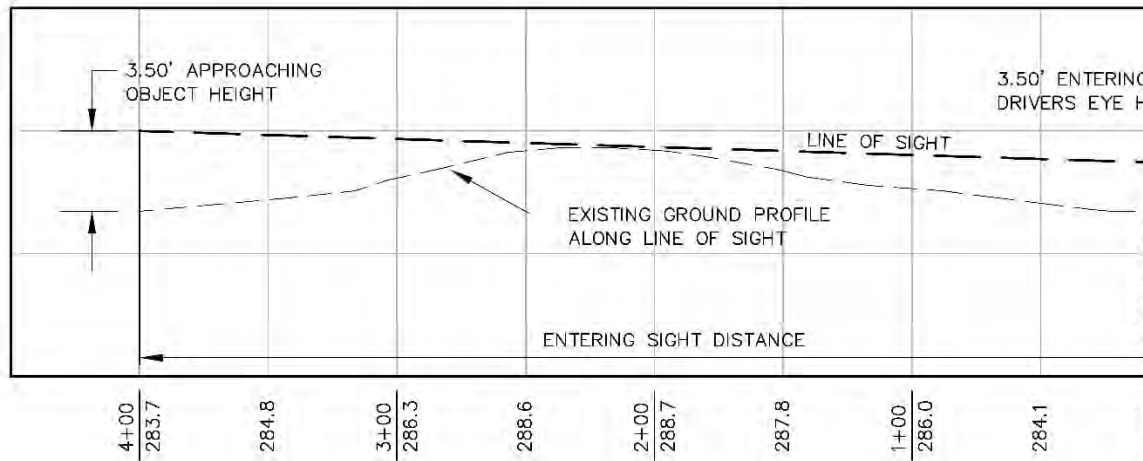

**PROFILE EXAMPLE**

NTS



**KITSAP COUNTY**  
DEPARTMENT OF PUBLIC WORKS



**STANDARD DETAIL**

EXAMPLE DEPARTURE SIGHT DISTANCE DIAGRAM

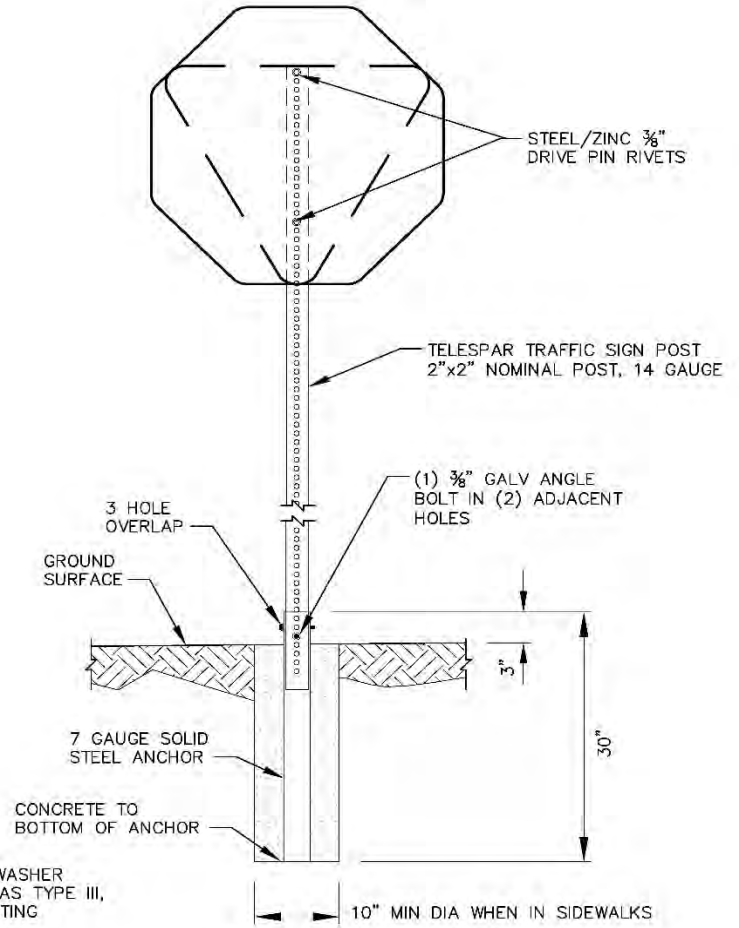

**KITSAP COUNTY**  
DEPARTMENT OF PUBLIC WORKS



## STANDARD DETAIL

TYPE ST-2 SIGN SUPPORT

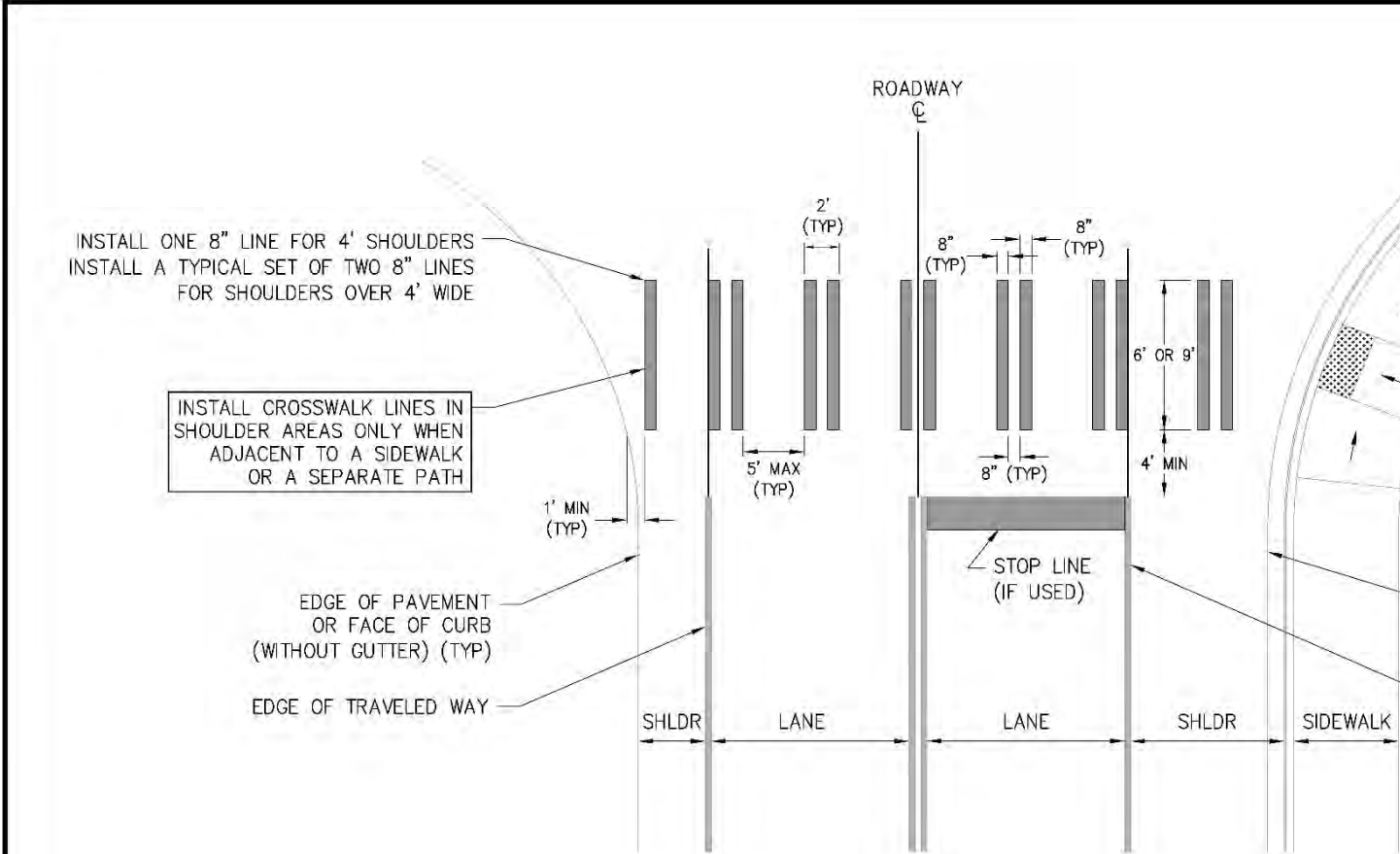

**GENERAL NOTES**

1. LOCATE CROSSWALK LINES OUTSIDE OF AND PARALLEL TO THE WHEEL PATHS.
2. INSTALL 6' CROSSWALK LINES FOR CONTROLLED CONDITION AND 9' CROSSWALK LINES FOR UNCONTROLLED CONDITION.
3. FOR SKEWED CROSSWALKS, CONSIDER INSTALLING 9' CROSSWALK LINES BASED ON ENGINEERING JUDGEMENT.



**KITSAP COUNTY**  
DEPARTMENT OF PUBLIC WORKS



**STANDARD DETAIL**

TYPICAL THERMOPLASTIC CROSSWALK PAVEMENT MARKING



PHASE DIAGRAM

RING 1		RING 2	
ø1			ø5
ø2			ø6
ø3			ø7
ø4			ø8

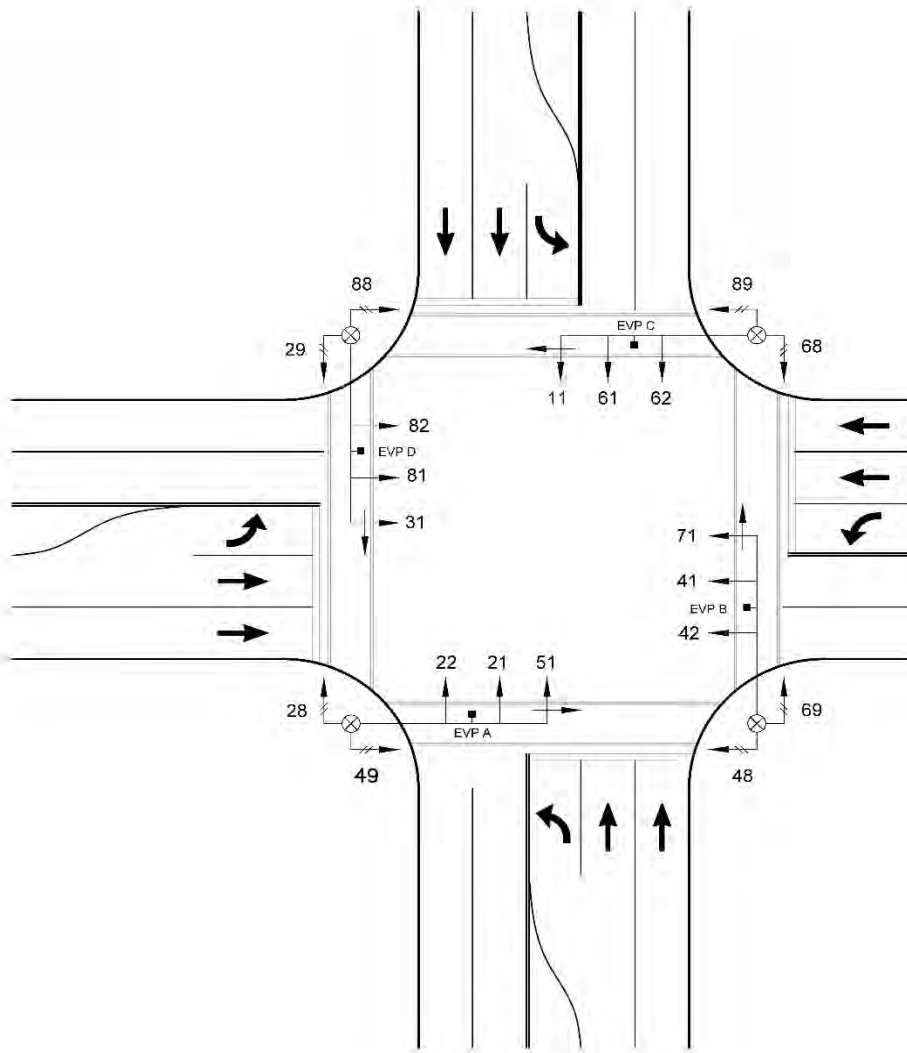

**KITSAP COUNTY**  
DEPARTMENT OF PUBLIC WORKS



**STANDARD DETAIL**

TRAFFIC SIGNAL PHASING – TYPICAL FOUR LEG INTERS

### TYPE 1

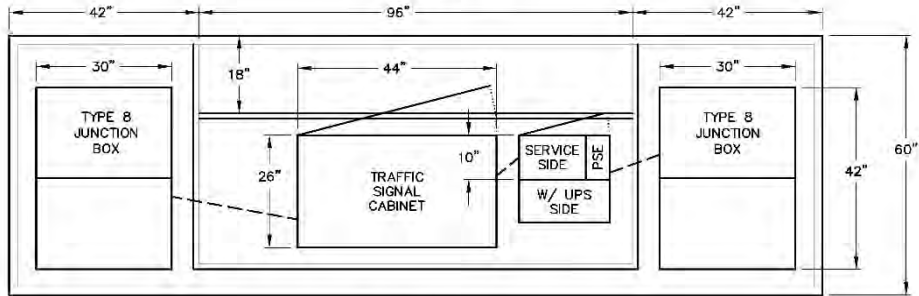

PLAN VIEW

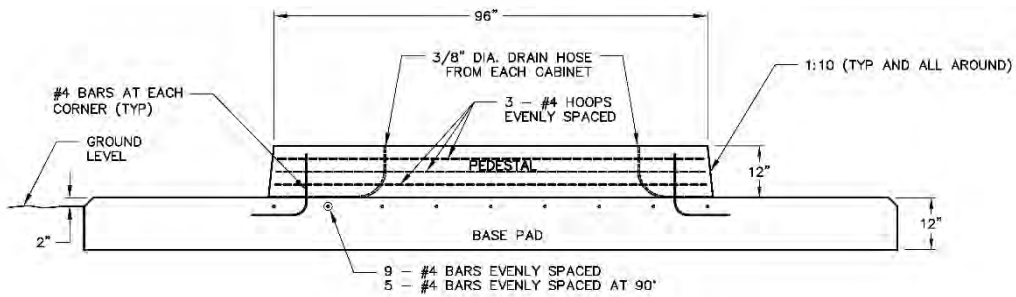

PROFILE VIEW

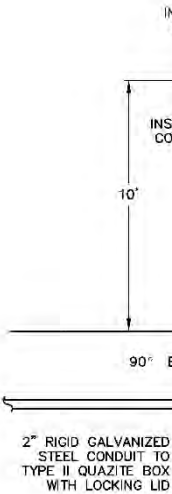

UTILITY P...



**KITSAP COUNTY**  
DEPARTMENT OF PUBLIC WORKS



## STANDARD DETAIL

ELECTRICAL CABINET FOUNDATION — TYPE 1

# TYPE 2

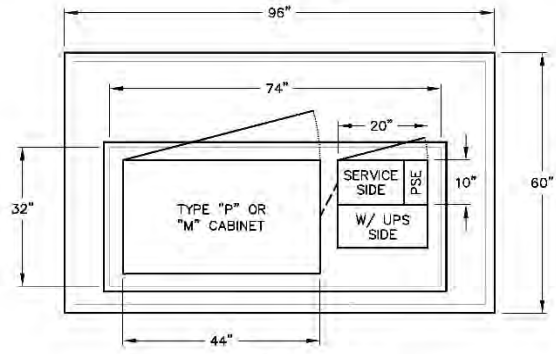

PLAN VIEW

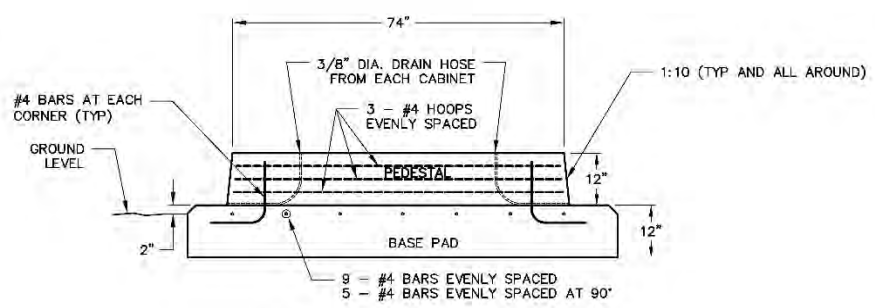

PROFILE VIEW

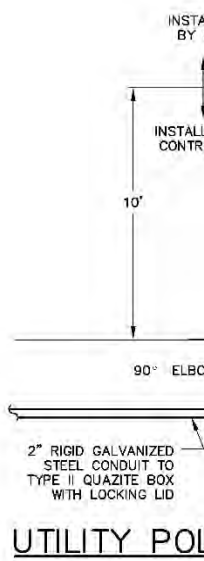

UTILITY POLE



**KITSAP COUNTY**  
DEPARTMENT OF PUBLIC WORKS



## STANDARD DETAIL

ELECTRICAL CABINET FOUNDATION – TYPE 2



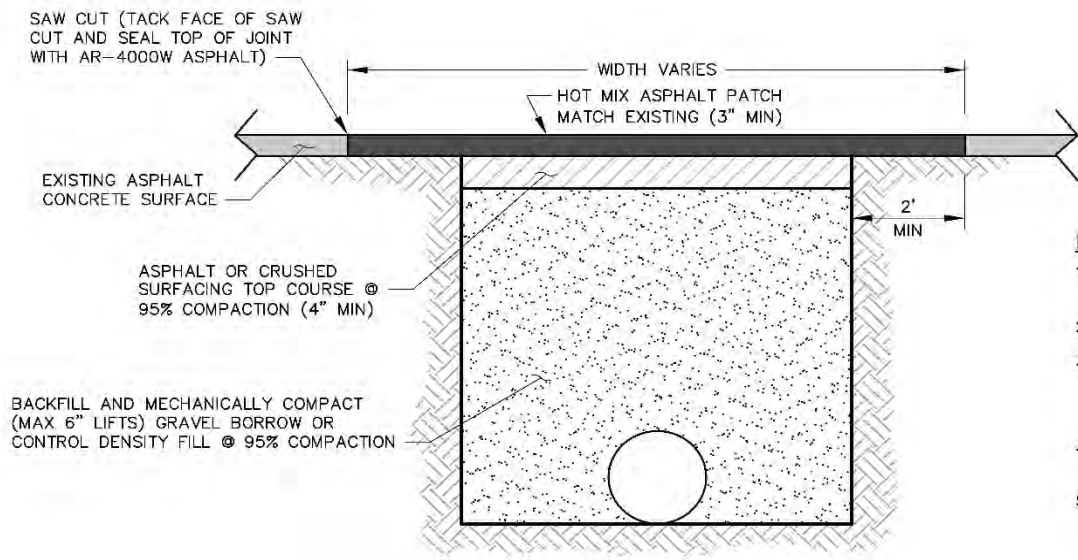

**NOTES**

1. ALL UTILITIES SHALL BE OTHERWISE APPROVED
2. ROADWAY PUSHES & B
3. IF ROAD CLOSURES OR TRAFFIC PLAN INCLUDING OF SUCH ACTIONS SHALL OF PUBLIC WORKS PER
4. THE APPLICANT IS RES PERMANENT PATCHING
5. NO OPEN TRENCHES L



**KITSAP COUNTY**  
DEPARTMENT OF PUBLIC WORKS



**STANDARD DETAIL**

STANDARD TRENCH AND PAVEMENT RESTORATION

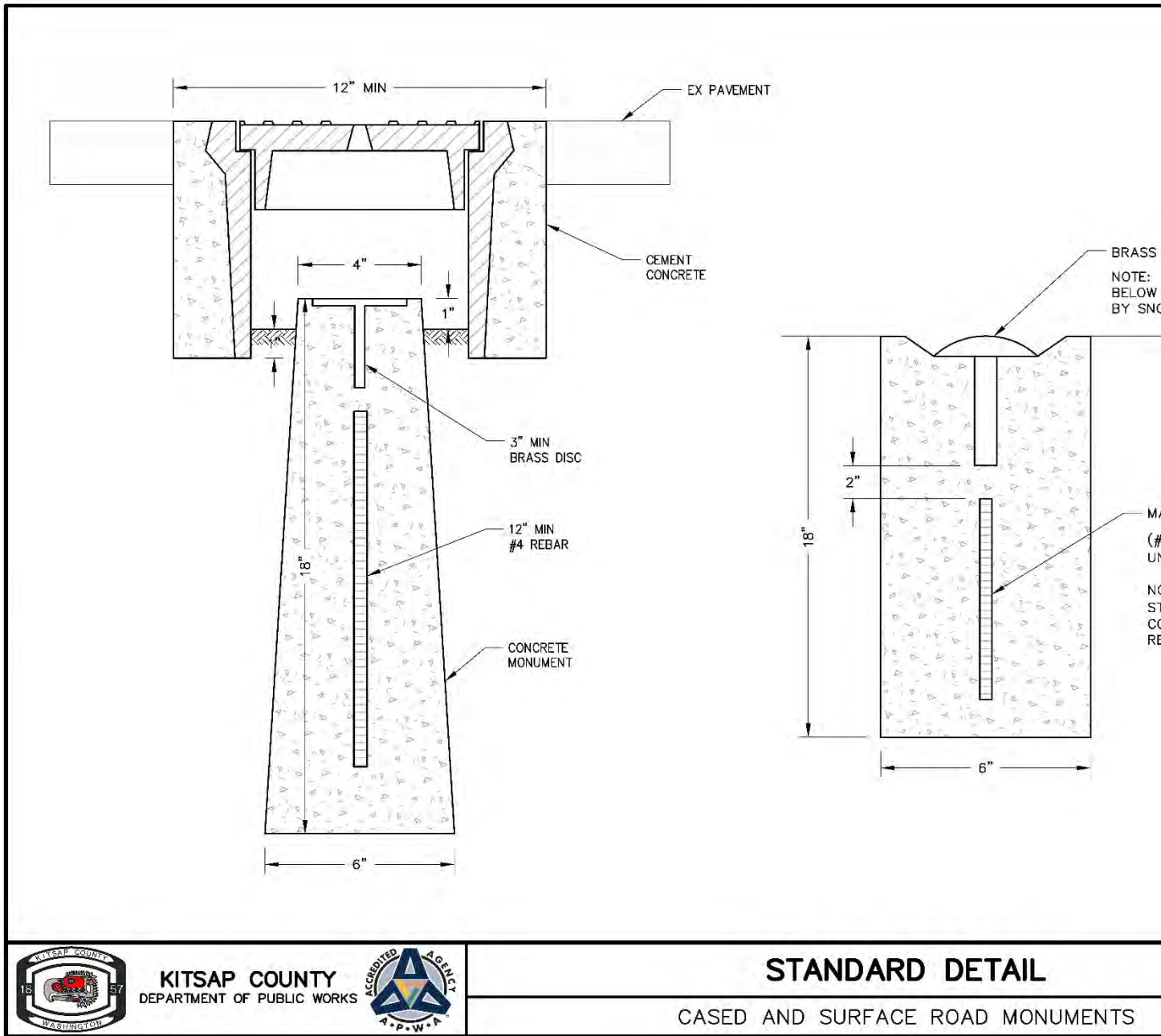

**KITSAP COUNTY**  
DEPARTMENT OF PUBLIC WORKS



## STANDARD DETAIL

CASED AND SURFACE ROAD MONUMENTS

~~It is the purpose of this chapter to provide for the safety, welfare and convenience of the traveling public within Kitsap County. In adopting this chapter, the county has sought to encourage standardization of road design elements where necessary for consistency and to assure, so far as practical, that motoring, bicycling, and pedestrian public safety needs are met. Considerations include safety, convenience, pleasant appearance, stormwater management, and economical maintenance. The Road Standards also provide requirements for the location and installation of utilities within the right-of-way.~~

~~The Road Standards are not intended to discourage innovative approaches for design and~~

~~construction of county roads and associated infrastructure. The application of low impact development methods providing equal levels of safety, workmanship and environmental protection as the adopted standards is encouraged.~~

~~Section 2. Kitsap County Code Section 11.22.040, adopted by Ordinance 293-2003, is amended as follows:~~

#### ~~11.22.040 — DEFINITIONS~~

~~**Bond** means a financial guarantee, in the form of a surety bond or assignment of funds, that shall guarantee compliance with this chapter.~~

~~**County Engineer** means the Kitsap County Road Engineer, having the authority specified in this chapter and under RCW 36.75.050 and 36.80, or his/her assigned designee.~~

~~**Department** means the Kitsap County Department of Public Works.~~

~~**Improvements** include, but are not limited to, the design and construction of roads, stormwater management facilities (i.e., storm drains, detention/retention ponds, bioswales, ditches, etc.), sidewalks, pedestrian trails, street lighting systems, signals and other traffic control devices, utilities, and bridges.~~

~~Reviewing Agency means the Kitsap County Department of Public Works.~~

~~Right-of-Way means all property in which the county has any form of ownership, interest or title, and which is held for the purpose of public roads and associated features such as, medians, sidewalks, bicycle facilities, and public utilities. This definition applies regardless of whether or not any road exists thereon or whether or not it is used, improved, or maintained for public travel.~~

~~Section 3. Kitsap County Code Section 11.22.050, adopted by Ordinance 293-2003, is amended as follows:~~

~~11.22.050 — APPLICATION OF STANDARDS~~

~~The Road Standards shall apply to all designed and newly constructed or reconstructed public roads within a Kitsap County right-of-way or on private property to be dedicated to Kitsap County for right-of-way by any person, firm, corporation or other entity. Work performed in the construction or improvement of county roads, whether by or for a private developer, shall be done in accordance with the Road Standards and plans and specifications approved by the county.~~

~~This chapter and the Road Standards are not intended to apply to general maintenance activities performed on roads in existence prior to January 13, 2003, the original date of adoption, as long as the maintenance activities do not significantly alter the dimensions or function of the road.~~

~~Land development activity that will impact the level of service, safety, or operational efficiency of existing roads, or that is required by other county code or ordinance to improve such roads, may be required to provide improvements in accordance with the Road Standards. The need for off-site improvements to existing county roads shall be based on an assessment of the potential impacts of the proposal.~~

~~Stormwater management requirements associated with road improvements shall comply with the requirements of Kitsap County stormwater management standards, codified under Title 12 of the Kitsap County Code, as they now exist or are hereafter amended.~~

~~Road improvements required under the Road Standards shall be designed by a Professional Engineer registered to practice in the State of Washington.~~

~~Section 4. Kitsap County Code Section 11.22.070, adopted by Ordinance 293-2003, is amended as follows:~~

~~11.22.070 — PERMITS~~

~~(a) No person, firm, partnership, association, joint venture, corporation, or other public or private legal entity shall construct or alter a permanent or temporary vehicular access to a county road without first obtaining a Road Approach permit from Kitsap County. A copy of the permit shall be available for inspection at the site during construction. Any change in land use or any improvement to an existing site that increases traffic volumes using an existing approach will require~~

a new Road Approach Permit.

~~(b) No person, firm, partnership, association, joint venture, corporation, or other public or private legal entity shall conduct any construction activity within a county right-of-way unless the work is in accordance with a valid "Permit to Perform Work in County Right-of-Way" issued by the Kitsap County Department of Public Works. A permit is not required for routine maintenance activities or repairs to aboveground utilities. Utility relocation work completed in conjunction with a county road improvement project does not require a permit. The applicant is required to be a qualified licensed and insured contractor in the State of Washington. Plans, drawings or other details that will enable the county to determine the location, size, length, time period and purpose of the permit being sought shall be furnished by the applicant. All permits that extend or alter existing and new waterline installations require review and approval by the Fire Marshal prior to application. Provided, however,~~

~~(1) A permit need not be obtained before performing emergency repairs upon existing underground utilities where the public health, safety and welfare is threatened if immediate repairs are not made; provided further,~~

~~(2) That as soon as practicable after the need for the emergency work is discovered or after the emergency repairs have been made, the person, firm, partnership, association, joint venture, corporation, or other public or private legal entity intending to make or having made the emergency repairs shall notify the Department of Public Works regarding the location, extent and nature of the repairs; and provided further,~~

~~(3) On the next working day immediately following the date of the emergency repair, the public or private entity having made such repairs shall submit an application for a permit to the Department of Public Works and shall comply with the Road Standards insofar as possible as determined by the Department of Public Works.~~

~~Section 5. Kitsap County Code Section 11.22.080, adopted by Ordinance 293-2003, is amended as follows:~~

#### ~~11.22.080 — TECHNICAL DEVIATION~~

~~The County Engineer may grant minor technical deviations from requirements contained in the Road Standards, provided that all of the following criteria are met:~~

~~(1) The technical deviation will not otherwise result in non-compliance with the Road Standards or any other applicable code; and~~

~~(2) The granting of the technical deviation will not result in non-compliance with development conditions imposed upon a project by the Department of Community Development, the Hearing Examiner and/or Board of Commissioners; and~~

~~(3) The granting of the technical deviation will produce a compensating or~~

comparable result that is in the public interest, and;

- (4) ~~The granting of the technical deviation will meet the objectives of safety, function, appearance, environmental protection and maintainability based on sound engineering judgment.~~

~~Section 6. Kitsap County Code Section 11.22.090, adopted by Ordinance No. 293-2003, is repealed.~~

~~Section 7. Kitsap County Code Section 11.22.110, adopted by Ordinance 293-2003, is amended as follows:~~

#### ~~11.22.110 — PENALTIES/ENFORCEMENT~~

~~(a) General: In addition to all other enforcement actions authorized under the code, the county may withhold or withdraw plan or development permit approval, revoke approval, forfeit the submitted financial guarantee, and/or refuse to accept work performed, if a permittee fails to comply with any requirement set forth in this chapter or the Road Standards. Further, Kitsap County may bring civil suit to enforce any requirement, enjoin violation or seek any other remedy available at law or equity.~~

~~(b) Road Approaches: Failure to Construct Properly. In addition to all other enforcement actions authorized under the code, any person, firm, partnership, association, joint venture, corporation or other legal entity who fails to construct an approach properly will be required to compensate the county for the improvement or removal of the approach. Compensation shall include administration time as well as equipment and materials to remove or improve the approach. Reimbursement shall be made to the Kitsap County Department of Public Works.~~

~~(c) Failure to Notify: In addition to all other enforcement actions authorized under the code, if a permittee fails to notify the county as required by the Road Standards then Kitsap County may require sampling and/or testing post construction, either by the Project Engineer or Kitsap County. Costs for such testing and/or sampling shall be borne by the permittee. When such testing and/or sampling is required, the county may prohibit or limit further work until all such tests and/or sampling have been completed and corrections made to the satisfaction of the county. In addition to this provision, the county reserves its right to bring any or all other enforcement action for the failure to notify.~~

~~Section 8. Kitsap County Code Section 11.22.120, adopted by Ordinance 293-2003, is amended as follows:~~

#### ~~11.22.120 — BONDING/INSURANCE/INDEMNIFICATION~~

- ~~(a) — A permittee shall post a financial guarantee in the form of a surety bond or~~

assignment of funds from a corporation authorized to do the business of surety in the State of Washington. The bond is required to ensure compliance with all permit conditions and shall be kept in full force and effect for a minimum



~~of two years following acceptance of the work as complete by the county. The bond shall be in favor of the Department of Public Works and is required prior to permit approval. The amount of the bond shall be as determined by the county~~

~~7~~

~~(b) — If a person, firm partnership, association, joint venture, corporation, or other public or private entity locates, installs, adjusts, repairs or relocates underground utility lines on a regular basis, the county may allow such entity to post a blanket bond in an amount no less than five thousand dollars. If an entity that has posted a blanket bond thereafter makes application for a permit, on a project of such magnitude that the county determines that the amount of the blanket bond is inadequate, the county may require a separate, additional bond.~~

~~(c) — Commercial Liability Insurance. Prior to beginning any work, and through the term of the maintenance bond, the permittee shall maintain commercial general liability insurance in the amount of not less than one million dollars (\$1,000,000) combined single limit bodily injury and property damage, with a two million dollar (\$2,000,000) aggregate. Prior to issuing a permit to work in the right-of-way, a permit applicant must provide the county with a certificate of insurance, signed by the insurance agent and the permit applicant. The policy shall be endorsed and the certificate shall name Kitsap County as an additional insured on the policy with respect to activities performed under this permit and through the term covered by the maintenance bond. The policy shall be endorsed and the certificate shall reflect that the insurance provided shall be primary insurance and any insurance or self-insurance carried by the county shall be excess and not contributory to that provided by the permittee. If, for any reason, a material change occurs in the insurance coverage during the period of time required by this provision, such changes shall not become effective until forty-five (45) days after Kitsap County has received written notice of such changes.~~

~~(d) — Waiver of requirements. The bonding and insurance requirements described in Sections 11.22.120 (a) — (c) may be waived at the discretion of the County Engineer.~~

~~(e) — Indemnification. The holder of any right-of-way permit shall have no recourse whatsoever against Kitsap County or its officials, boards, commissions, agents, or employees for any loss, costs, expenses, or damages arising out of any provision or requirement of the permit or Road Standards, or because of Kitsap County enforcement activities. Granting of a franchise or permit shall not imply or be construed to mean the county shall be responsible for the design, construction, or operation of the facility or for public safety during the facility's installation, operation, or maintenance.~~

~~Section 9. Severability. If any provision of this Ordinance, or its application to any person, entity or circumstance is for any reason held invalid, the remainder of the Ordinance, or the application of the provision to other persons, entities or circumstances are not affected.~~

~~Section 10. Effective Date. This Ordinance shall be in full force and effect 60 days following adoption by the Board of County Commissioners.~~

~~ENACTED~~ this \_\_\_\_\_ day of \_\_\_\_\_, 2007.

~~BOARD OF COUNTY COMMISSIONERS  
KITSAP COUNTY, WASHINGTON~~

\_\_\_\_\_  
~~JOSH BROWN, Chair~~

ATTEST

\_\_\_\_\_  
~~JAN ANGEL, Commissioner~~

\_\_\_\_\_  
~~Opal Robertson  
Clerk of the Board~~























\_\_\_\_\_  
~~STEPHEN BAUER, Commissioner~~

APPROVED AS TO FORM:

~~DEPUTY PROSECUTING ATTORNEY~~

~~APPENDIX — A~~



<b>Botanical Name</b>	<del>6-foot min.</del> 6' min. planter width	<del>8-foot min.</del> 8' min. planter width	<del>10-foot min.</del> 10' min. planter width	10' - 20' spread	20' - 30' spread	30' - 40' spread	Over <del>40'</del> 40' spread	Slow <del>growth rate</del> Growth Rate	Medium <del>growth rate</del> Growth Rate	Fast <del>growth rate</del> Growth Rate	Drought tolerant	Tolerates poor drainage	
<u>American Hornbeam</u> <i>Carpinus caroliniana</i>  <del>American Hornbeam</del>	x 				x 					x 			Round canopy, yellow/red fall color.
<u>Eastern Redbud</u> <i>Cercis Canadensis</i>													<u>Horizontal branching, red petioles.</u>
<u>Korean Dogwood</u> <i>Cornus kousa</i>													<u>Delicate, upright branching, white flowers.</u>
<u>Pacific Dogwood</u> <i>Cornus nuttallii</i>													<u>Disease-prone native, open habit.</u>
<u>Raywood Ash</u> <i>Fraxinus oxycarpa</i>													<u>Seedless, reddish fall color.</u>
<u>Star Magnolia</u> <i>Magnolia stellata</i>													<u>Shrubby tree, fine texture, white flowers.</u>
<u>European Mountain Ash</u> <i>Sorbus aucuparia</i>													<u>Compound leaves, showy orange berries.</u>

**Small Sized Trees ( 30' or less)**

Botanical Name														Comments/Notes
Common Name	6-foot min. plants width	8-foot min. plants width	10-foot min. plants width	10' - 20' spread	20' - 30' spread	30' - 40' spread	Over 40' spread	Slow growth rate	Medium growth rate	Fast growth rate	Drought tolerant	Tolerates poor drainage		
<i>Cercis canadensis</i>														
Eastern Redbud	X				X					X				Horizontal branching, red petioles.
<i>Cornus kousa</i>														Delicate, upright branching, white flowers.
Korean Dogwood	X				X			X			X			Disease-prone native, open habit.
<i>Cornus nuttallii</i>														
Pacific Dogwood	X				X			X			X			
<i>Crataegus laevvallei</i>														

Lavalle Hawthorn \_\_\_\_\_ X \_\_\_\_\_ X \_\_\_\_\_ X

*Crataegus mollis*

Glossy foliage, orange fruit, smooth bark.

Downy Hawthorn \_\_\_\_\_ X \_\_\_\_\_ X \_\_\_\_\_ X

*Crataegus viridis*

Smooth, glossy foliage, white flowers.

'Winter King'

Winter King Green Hawthorn \_\_\_\_\_ X \_\_\_\_\_ X \_\_\_\_\_ X

*Crataegus phaenopyrum*

Wide, broad-spreading crown.

Washington Hawthorn \_\_\_\_\_ X \_\_\_\_\_ X \_\_\_\_\_ X

*Fraxinus oxycarpa*

Glossy leaves, white flowers, red fruit.

Raywood Ash \_\_\_\_\_ X \_\_\_\_\_ X \_\_\_\_\_ X

Seedless, reddish fall color.



**Small Sized Trees ( 30' or less)**

Botanical Name	6 feet min. planter width	8 feet min. planter width	10 feet min. planter width	10' - 20' spread	20' - 30' spread	30' - 40' spread	Over 40' spread	Slow growth rate	Medium growth rate	Fast growth rate	Drought tolerant	Tolerates poor drainage		Comments/Notes
<i>Magnolia stellata</i>				x				x						Shrubby tree, fine texture, white flowers.
<i>Sorbus aucuparia</i>	x				x				x					Compound leaves, showy orange berries.



## KITSAP COUNTY APPROVED STREET TREES

### Medium Sized Trees (30' to 50')

Botanical Name	6-feet <sup>6'</sup> min. planter width	8-feet <sup>8'</sup> min. planter width	10-feet <sup>10'</sup> min. planter width	10' - 20' spread	20' - 30' spread	30' - 40' spread	Over 40-40' spread	Slow growth rate.Growth_Rate	Medium growth rate.Growth_Rate	Fast growth rate.Growth_Rate	Drought tolerant	Tolerates poor drainage
Common Name												

### MEDIUM SIZED TREES (30' TO 50')

<u>Sycamore Maple</u> <i>Acer pseudoplatanum</i>  Sycamore Maple	*					*			*			Similar to Platanus.
<u>Red Maple</u> <i>Acer rubrum</i>  Red Maple	*					*				*		Scarlet fall color ('Armstrong' var. spire-like)
<u><del>Betula jacquemontii</del></u>  Jacquemontii Birch <u>Betula jacquemontii</u>	*					*			*			Tall, narrow, brilliant white bark.
<u><del>Betula Paper Birch</del></u> <u>Betula papyrifera</u>  Paper Birch	*						*		*			Classic white peeling bark, yellow fall color.
<u>Pyramidal European Hornbeam</u> <i>Carpinus <del>betulus</del></i> <i>betulus</i> 'Fastigiata'												Dense, clean foliage, pyramidal in form.



**Medium Sized Trees (30' to 50')**

Botanical Name	6-foot min. planter width	8-foot min. planter width	10-foot min. planter width	10'-20' spread	20'-30' spread	30'-40' spread	Over 40' spread	Slow growth rate	Medium growth rate	Fast growth rate	Drought tolerant	Tolerates poor drainage	Comments/Notes
<i>Corylus columna</i>													Upright form, pest free, corky bark.
<i>Pyrus calleryana</i>	x				x			x			x		Bright red fall color, 'Aristocrat' var. pyramidal.
<i>Zelkova serrata</i>	x				x					x	x		Rough-textured shade tree, smooth grey bark.



## KITSAP COUNTY APPROVED STREET TREES

### Medium Sized Trees (30' to 50')

Botanical Name	6-foot min. planter width	8-foot min. planter width	10-foot min. planter width	10' - 20' spread	20' - 30' spread	30' - 40' spread	Over 40' spread	Slow growth rate	Medium growth rate	Fast growth rate	Drought tolerant	Tolerates poor drainage	Comments/Notes
Common Name													
<i>Acer pseudoplatanum</i>													Similar to Platanus.
Sycamore Maple	X					X			X				
<i>Acer rubrum</i>													Scarlet fall color ('Armstrong' var. spire-like)
Red Maple	X					X				X			
<i>Betula jacquemontii</i>													Tall, narrow, brilliant white bark.
Jacquemontii Birch	X					X			X				
<i>Betula papyrifera</i>													Classic white peeling bark, yellow fall color.
Paper Birch	X						X		X				
<i>Carpinus betulus</i> 'Fastigiata'													Dense, clean foliage, pyramidal in form.
Pyamidal European Hornbeam	X				X				X		X		
<i>Cladrastis lutea</i>													Broad, round head, fragrant flowers.
Yellowwood Tree	X				X			X					
<i>Geltis laevigata</i> 'All Seasons'													Open shade tree.
All Seasons Sugar Hackberry	X					X			X			X	
<i>Cercidphyllum japonicum</i>													Soft textured spreading shade tree.
Katsura Tree	X						X	X					

**Medium Sized Trees (30' to 50')**

Botanical Name	6-foot min. planter width	8-foot min. planter width	10-foot min. planter width	10'-20' spread	20'-30' spread	30'-40' spread	Over 40' spread	Slow growth rate	Medium growth rate	Fast growth rate	Drought tolerant	Tolerates poor drainage	Comments/Notes
<i>Corylus columna</i>													Upright form, pest free, corky bark.
<i>Pyrus calleryana</i>	x				x			x			x		Bright red fall color, 'Aristocrat' var. pyramidal.
<i>Zelkova serrata</i>	x				x					x	x		Rough-textured shade tree, smooth grey bark.

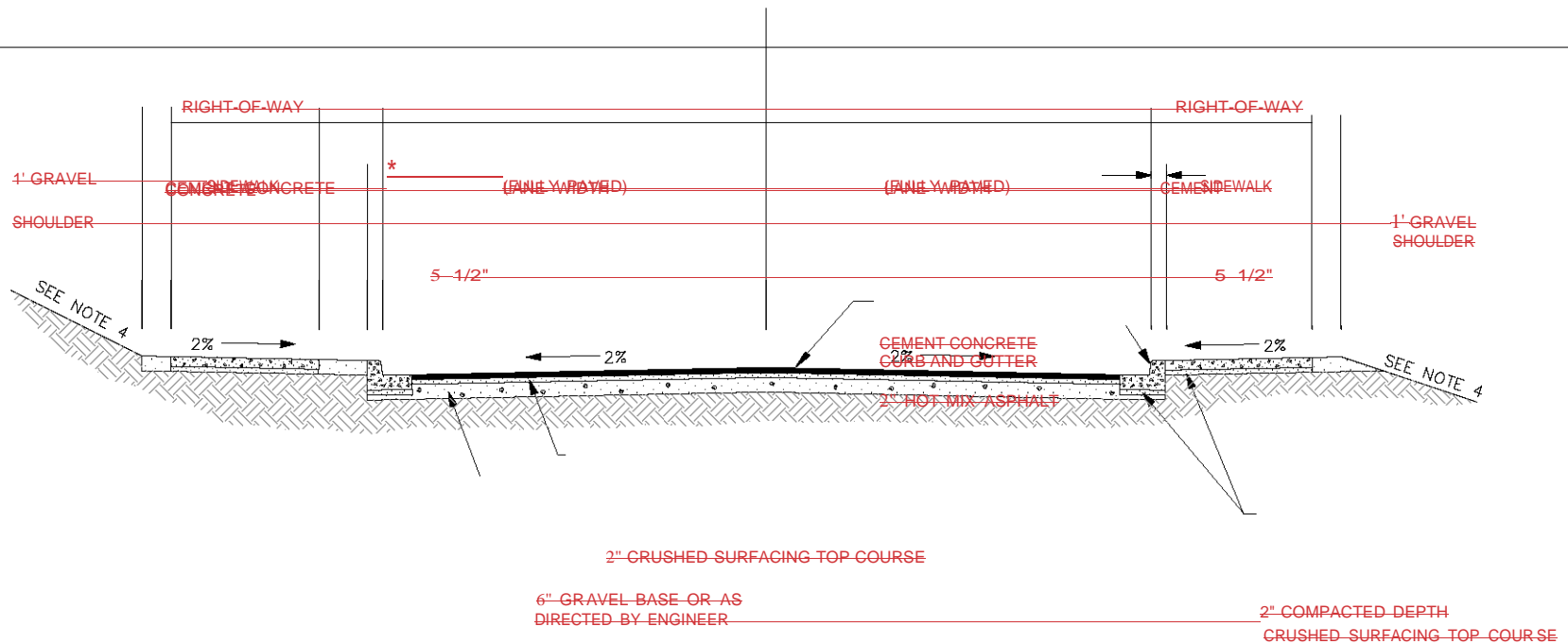

## TYPICAL URBAN ROADWAY SECTION

SEE SECTION 3.7  
NTS

### NOTES:

1. SURFACING DEPTHS SHOWN ARE MINIMUMS FOR ARTERIAL ROADS AND SHALL BE DESIGNED WITH A STRUCTURAL SECTION THAT TAKES INTO ACCOUNT THE LOAD BEARING CAPACITY OF THE SOILS AND THE TRAFFIC CARRYING REQUIREMENTS OF THE ROADWAY. PLANS SHALL BE ACCOMPANIED BY THE SOILS AND TRAFFIC ANALYSIS ON WHICH THE DESIGN IS BASED.
  2. WHEN NATIVE SUBGRADE MATERIAL MEETS THE SPECIFICATIONS FOR GRAVEL BASE, THE 6" GRAVEL BASE COURSE CAN BE ELIMINATED OR SUBSTITUTED WITH A LESSER THICKNESS OF GRAVEL BASE OR EQUIVALENT MATERIAL.
  3. CURBED SECTION SHALL BE USED IN ALL URBAN AREAS UNLESS A DEVIATION IS APPROVED.
  4. SIDE SLOPES SHALL BE CONSTRUCTED NO STEEPER THAN 2H:1V FOR LOCAL ROADS AND 3H:1V FOR CUT SLOPES AND 4H:1V FOR FILL SLOPES ON ARTERIALS UNLESS A TRAFFIC BARRIER OR ADEQUATE JUSTIFICATION IS PROVIDED.
  5. RIGHT-OF-WAY WIDTHS SHALL BE INCREASED AS NECESSARY TO ACCOMMODATE ADDITIONAL LANES.
  6. SEE WSDOT STANDARD SPECIFICATION FOR VERTICAL CURB, GUTTER, AND SIDEWALK CRITERIA.
  7. SIDEWALK WIDTH AND LOCATION SHALL MATCH EXISTING CONDITIONS AND/OR COMPLY WITH CURRENT AREA PLANNING DOCUMENTS AND CONDITIONS OF DEVELOPMENT APPROVAL.
- \* PLANTER STRIP AS REQUIRED.



614 DIVISION STREET MS-26  
PORT ORCHARD, WA 98366  
TEL: (360) 337-5777 FAX: (360) 337-1867

**CEMENT CONCRETE BARRIER CURB, GUTTER, AND SIDEWALK**

**FIGURE 3-1**



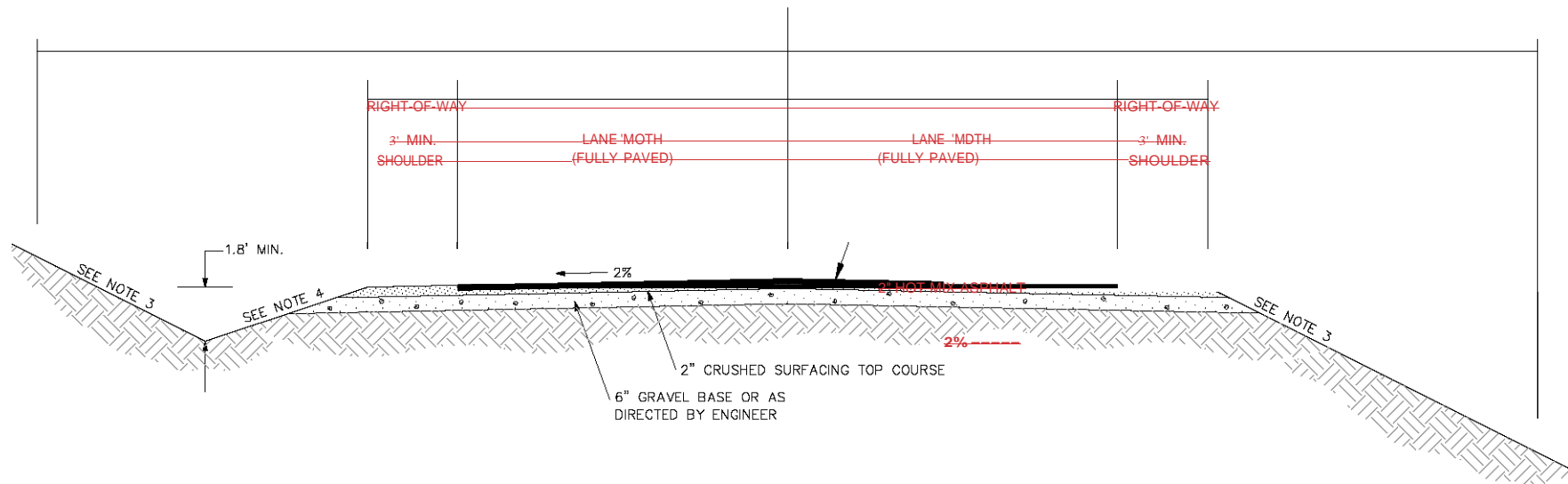

## TYPICAL RURAL ROADWAY SECTION

SEE SECTION 3.7  
NTS

### NOTES:

1. SURFACING DEPTHS SHOWN ARE MINIMUMS FOR ARTERIAL ROADS AND SHALL BE DESIGNED WITH A STRUCTURAL SECTION THAT TAKES INTO ACCOUNT THE LOAD BEARING CAPACITY OF THE SOILS AND THE TRAFFIC CARRYING REQUIREMENTS OF THE ROADWAY. PLANS SHALL BE ACCOMPANIED BY THE SOILS AND TRAFFIC ANALYSIS ON WHICH THE DESIGN IS BASED.
2. WHEN NATIVE SUBGRADE MEETS THE SPECIFICATIONS FOR GRAVEL BASE, THE 6" GRAVEL BASE COURSE CAN BE ELIMINATED OR SUBSTITUTED WITH A LESSER THICKNESS OF GRAVEL BASE OR EQUIVALENT MATERIAL.
3. SIDE SLOPES SHALL BE CONSTRUCTED NO STEEPER THAN 2H:1V FOR LOCAL ROADS AND 3H:1V FOR CUT SLOPES AND 4H:1V FOR FILL SLOPES ON ARTERIALS UNLESS A TRAFFIC BARRIER OR ADEQUATE JUSTIFICATION IS PROVIDED.
4. DITCH (IN-SLOPE) SHALL NOT EXCEED 4H:1V FOR ARTERIALS AND 2H:1V FOR LOCAL ROADS.
5. RIGHT-OF-WAY WIDTHS SHALL BE INCREASED AS NECESSARY TO ACCOMMODATE ADDITIONAL LANES.



KITSAP COUNTY  
DEPT. OF PUBLIC WORKS  
614 DIVISION STREET MS-26  
PORT ORCHARD, WA 98366  
TEL: (360) 337-5777 FAX: (360) 337-1867

~~TYPICAL RURAL ROADWAY SECTION~~  
~~GRAVEL SHOULDERS AND OPEN DRAINAGE~~

Date: ~~8/10/07~~  
~~41~~  
FIGURE 3-2

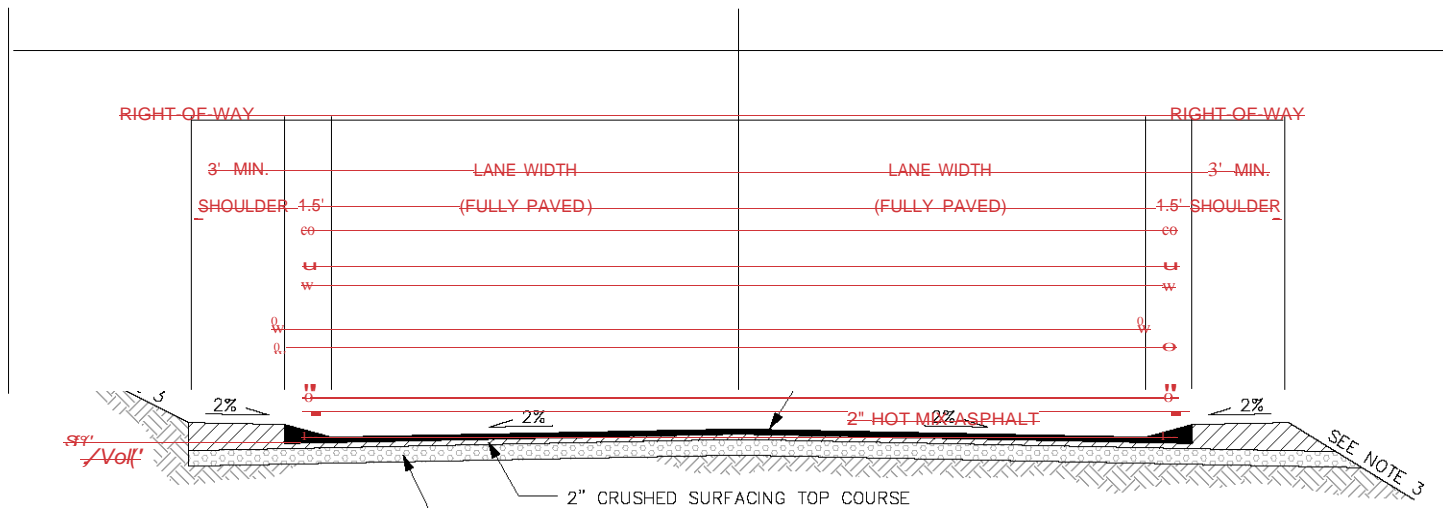

6" GRAVEL BASE OR AS DIRECTED BY ENGINEER

## TYPICAL RURAL ROADWAY SECTION

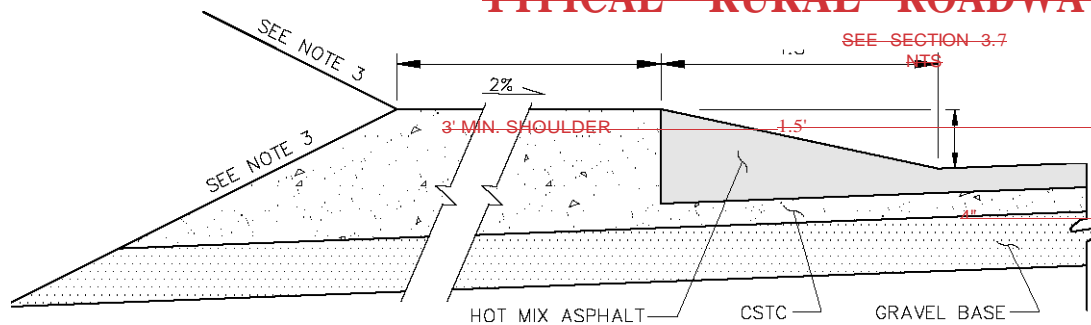

### NOTES:

1. SURFACING DEPTHS SHOWN ARE MINIMUMS FOR ARTERIAL ROADS AND SHALL BE DESIGNED WITH A STRUCTURAL SECTION THAT TAKES INTO ACCOUNT THE LOAD BEARING CAPACITY OF THE SOILS AND THE TRAFFIC CARRYING REQUIREMENTS OF THE ROADWAY. PLANS SHALL BE ACCOMPANIED BY THE SOILS AND TRAFFIC ANALYSIS ON WHICH THE DESIGN IS BASED.
2. WHEN NATIVE SUBGRADE MATERIAL MEETS THE SPECIFICATIONS FOR GRAVEL BASE, THE 6" GRAVEL BASE COURSE CAN BE ELIMINATED OR SUBSTITUTED WITH A LESSER THICKNESS OF GRAVEL BASE OR EQUIVALENT MATERIAL.
3. SIDE SLOPES SHALL BE CONSTRUCTED NO STEEPER THAN 2H:1V FOR LOCAL ROADS AND 3H:1V FOR CUT SLOPES AND 4H:1V FOR FILL SLOPES ON ARTERIALS UNLESS A TRAFFIC BARRIER OR ADEQUATE JUSTIFICATION IS PROVIDED.
4. FUNCTIONAL CLASSIFICATION AND EXISTING ADT DEFINED BY KCDPW TRAFFIC TRANSFORMATION DIVISION.
5. RIGHT-OF-WAY WIDTHS SHALL BE INCREASED AS NECESSARY TO ACCOMMODATE ADDITIONAL LANES.

### ASPHALT THICKENED EDGE DETAIL

NTS



KITSAP COUNTY  
DEPT. OF PUBLIC WORKS

## TYPICAL RURAL ROADWAY SECTION

Date: 8/10/07

614 DIVISION STREET MS-26  
PORT ORCHARD, WA 98366  
TEL: (360) 337-5777 FAX: (360) 337-1867

**THICKENED EDGE CURB**

**FIGURE 3-3**

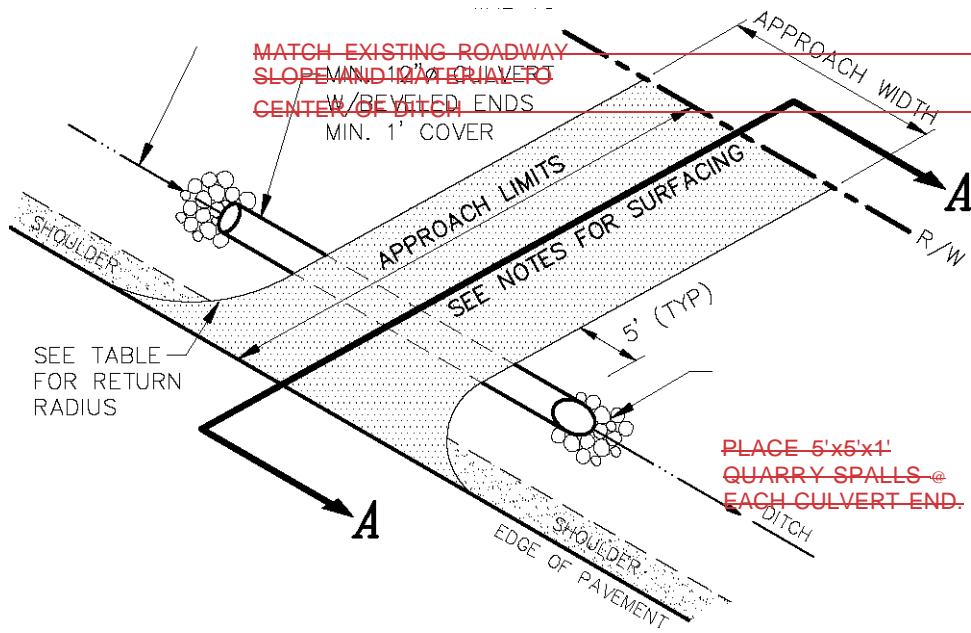

**RETURN RADIUS**

RESIDENTIAL APPROACH - LOCAL ROAD	10'
RESIDENTIAL APPROACH - SUB-COLLECTOR	15'
RESIDENTIAL APPROACH - COLLECTOR	20'
RESIDENTIAL APPROACH - MINOR ARTERIAL	25'
RESIDENTIAL APPROACH - PRINCIPAL ARTERIAL	30'
MAJOR APPROACH - ALL CLASSIFICATIONS	35'

**APPROACH WIDTH**

RESIDENTIAL	10'
MAJOR	20' MIN./36' MAX.

**PLAN**  
N.T.S.

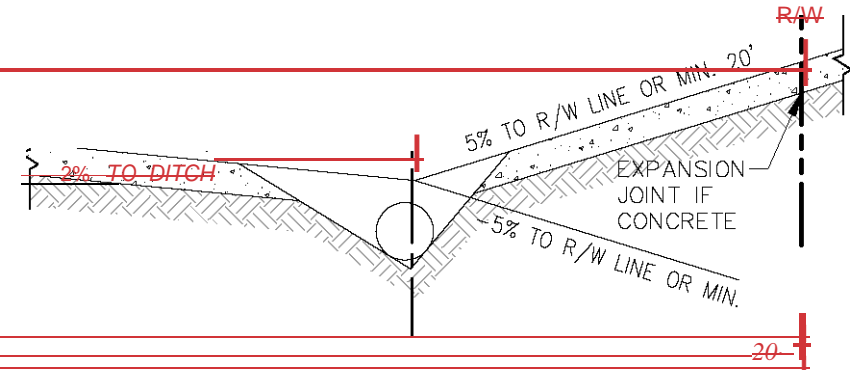

**SECTION A-A**  
N.T.S.

**NOTES:**

1. APPROACH PAVING - MINIMUM 2" COMPACTED DEPTH HOT MIX ASPHALT, OVER MINIMUM 2" COMPACTED DEPTH CRUSHED SURFACING TOP COURSE, OR MINIMUM 6" REINFORCED CEMENT CONCRETE.
2. ALL PORTLAND CEMENT CONCRETE APPROACHES REQUIRE AN INSPECTION OF INSTALLATION THE FORMS AND EXPANSION JOINT LOCATIONS PRIOR TO CONCRETE.
3. APPROACH SHALL NORMALLY BE AT 90 DEGREES TO ROAD CENTERLINE, BUT CAN VARY FROM 75 TO 105 DEGREES.
4. CULVERT PIPE MUST BE CONCRETE, CMP, OR CPEP WITH QUARRY SPALLS. MINIMUM LENGTH IS 20' OR DETERMINED BY WIDTH OF APPROACH PLUS 5' EACH END (EXCLUDING BEVELED END SECTIONS).

5. IF EXISTING COUNTY ROAD SURFACE IS OTHER THAN ASPHALT CONCRETE PAVEMENT, A LIKE MATERIAL MAY BE USED ON ROAD APPROACH.



0  
T. P. O. e-WORKS  
614 DIVISION STREET MS-26 PORT ORCHARD, WA 98366  
414 (36-0) 337-5777 FAX (36-0) 337-5778

~~RURAL RESIDENTIAL / MAJOR APPROACH~~  
~~GRAVEL SHOULDERS AND OPEN DRAINAGE~~

Date: 8/10/07

FIGURE 4-1

	"A"	"B"	"C"	"D"
RESIDENTIAL	10' MIN.	15' MIN.	5' MAX.	2.50'

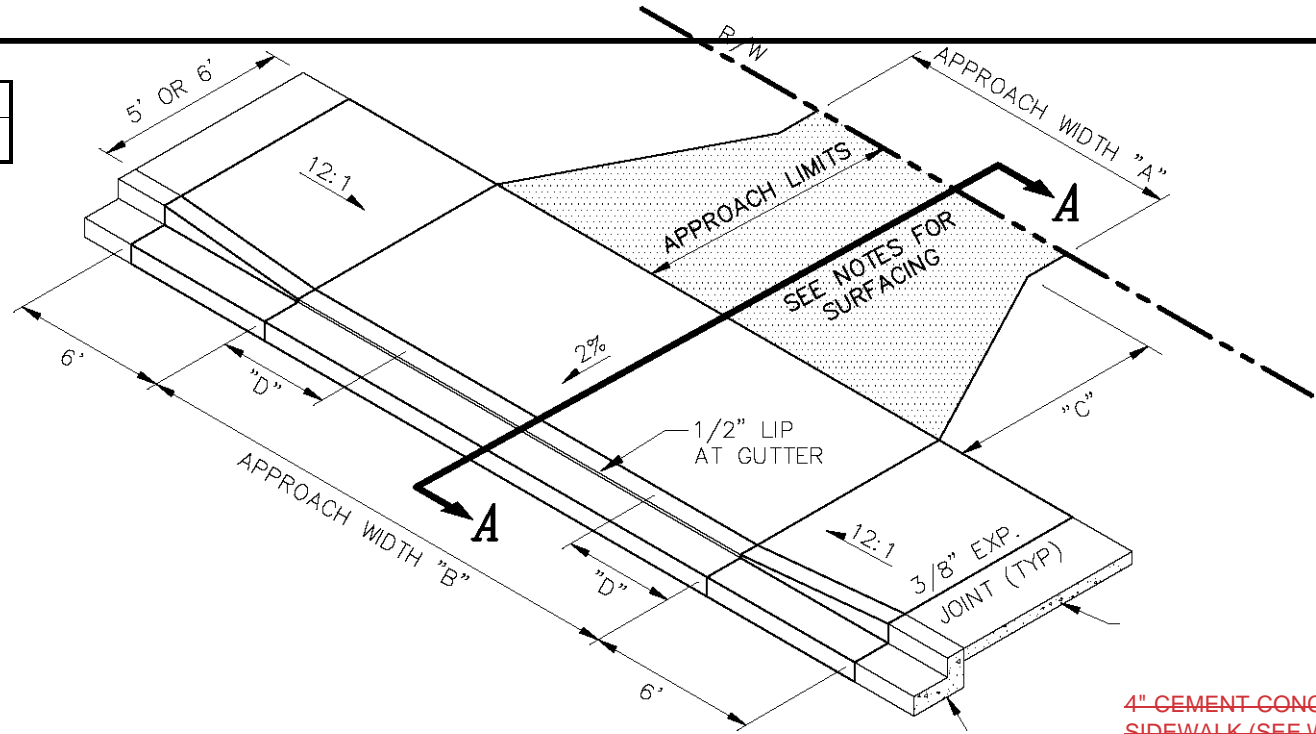

**NOTES:**

1. APPROACH PAVING - MINIMUM 2" COMPACTED DEPTH HOT MIX ASPHALT, OVER MINIMUM 2" COMPACTED DEPTH CRUSHED SURFACING TOP COURSE, OR MINIMUM 6" REINFORCED CEMENT CONCRETE.
2. ALL PORTLAND CEMENT CONCRETE APPROACHES REQUIRE AN INSPECTION OF THE FORMS AND EXPANSION JOINT LOCATIONS PRIOR TO CONCRETE INSTALLATION.
3. MAINTAIN 1/2" LIP AT GUTTER.
4. APPROACH SHALL NORMALLY BE AT 90 DEGREES TO ROAD CENTERLINE, BUT CAN VARY FROM 75 TO 105 DEGREES.
5. WHEN SIDEWALK IS ADJACENT TO A ROADWAY, THEN THE SLOPE IS ALLOWED TO MATCH THE PROFILE OF THE ROAD.
6. REFER TO CURRENT WSDOT STANDARDS FOR SPECIFIC WHEELCHAIR RAMP REQUIREMENTS.

**PLAN**

N.T.S.

CEMENT CONCRETE CURB AND GUTTER (SEE WSDOT STANDARD PLANS FOR DETAILS)

4" CEMENT CONCRETE SIDEWALK (SEE WSDOT STANDARD PLANS FOR DETAILS)

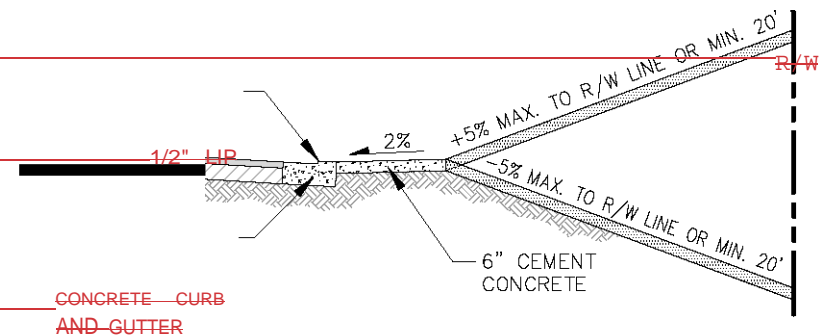

**SECTION A-A**

N.T.S.



⊕  
T. P. G. E-WORKS  
614 DIVISION STREET MS-26  
PORT ORCHARD, WA 98366  
+1 (360) 337-5777 FAX (360) 337-5777

~~URBAN RESIDENTIAL APPROACH~~

~~CEMENT CONCRETE BARRIER CURB, GUTTER, AND SIDEWALK~~

Date: ~~8/10/07~~

~~FIGURE 4-2~~



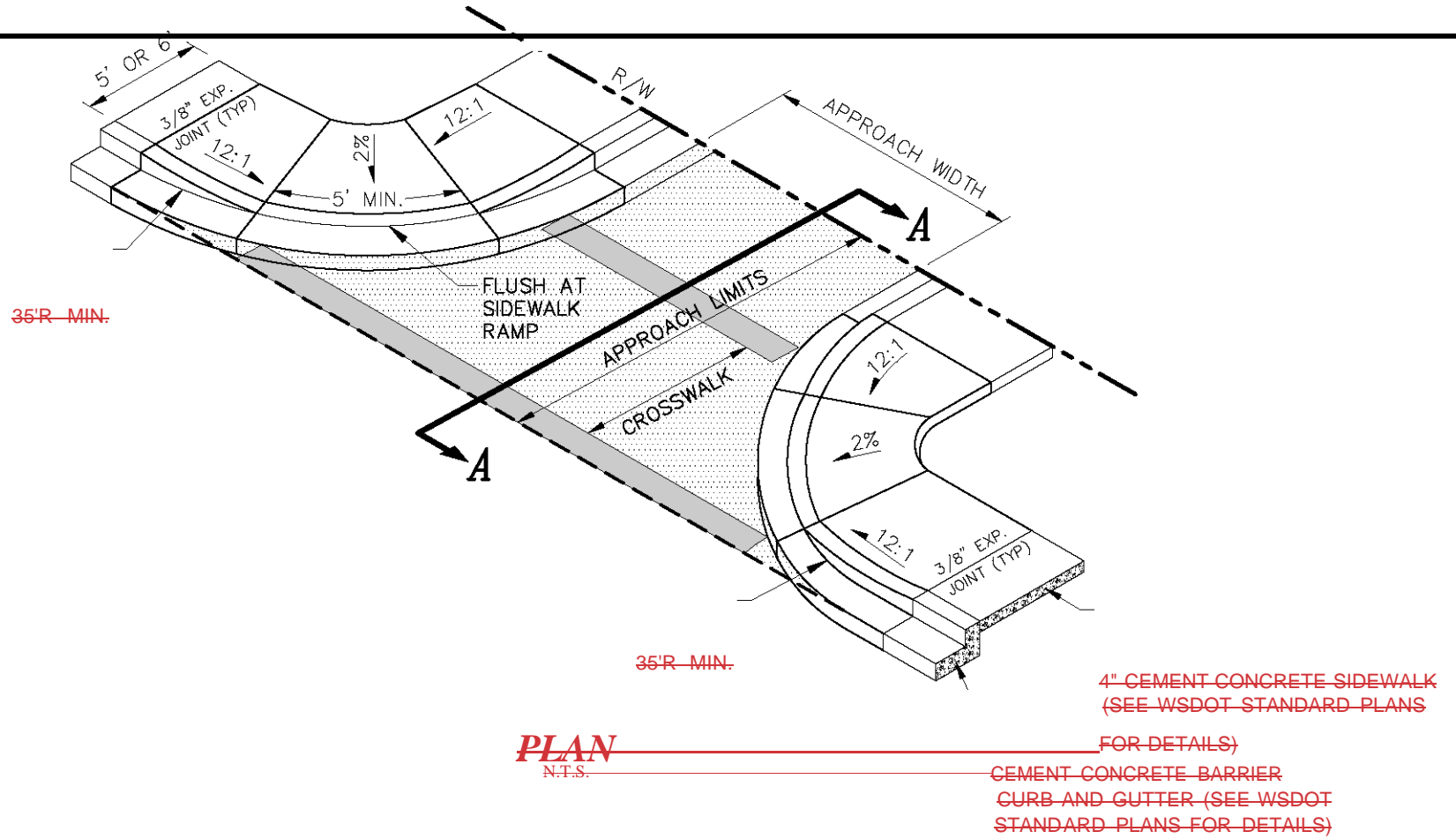

**NOTES:**

1. APPROACH WIDTH = 20' MIN. AND 36' MAX.
2. APPROACH PAVING = 2" MINIMUM COMPACTED DEPTH HOT MIX ASPHALT, OVER 2" MINIMUM COMPACTED DEPTH CRUSHED SURFACING TOP COURSE.
3. APPROACH SHALL NORMALLY BE AT 90 DEGREES TO ROAD CENTERLINE, BUT CAN VARY FROM 75 TO 105 DEGREES.
4. WHEELCHAIR RAMP REQUIREMENTS REFER TO CURRENT WSDOT STANDARDS FOR SPECIFIC

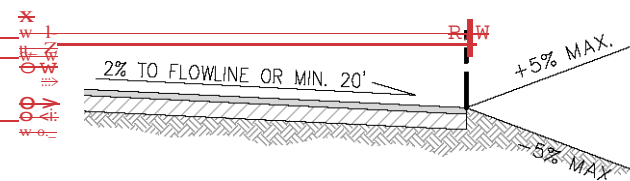

KITSAP COUNTY  
DEPT. OF PUBLIC WORKS  
614 DIVISION STREET MS-26  
PORT ORCHARD, WA 98366  
TEL: (360) 337-5777 FAX: (360) 337-1867

~~URBAN MAJOR APPROACH~~  
~~CEMENT CONCRETE BARRIER CURB, GUTTER, AND SIDEWALK~~

Date: ~~8/10/07~~  
~~FIGURE 4-3~~



### SIGHT DISTANCE DETAIL

NTS

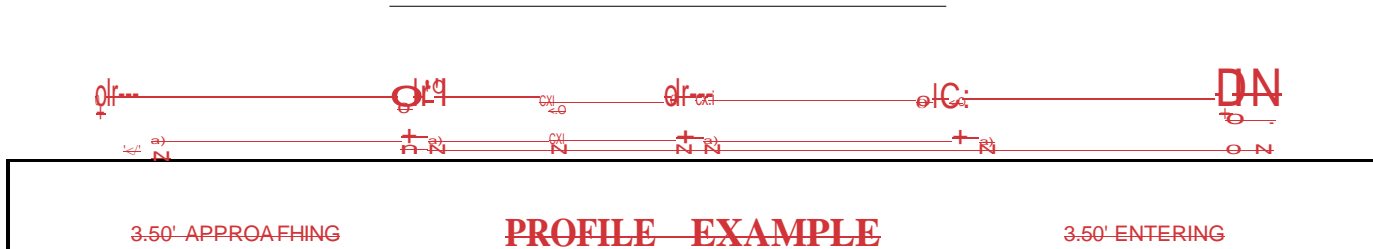

NTS

KITSAP COUNTY  
 DEPT. OF PUBLIC WORKS  
 614 DIVISION STREET MS-26  
 PORT ORCHARD, WA 98366  
 TEL: (360) 337-5777 FAX: (360) 337-1867

### EXAMPLE DEPARTURE SIGHT DISTANCE DIAGRAM

### DETAIL AND PROFILE

Date: 8/10/07

FIGURE 4-4



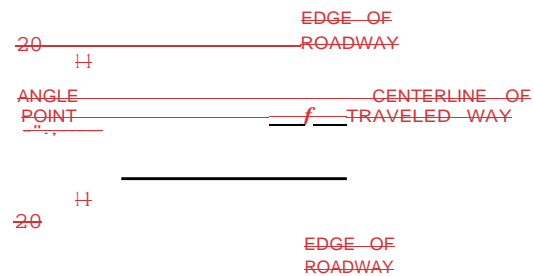
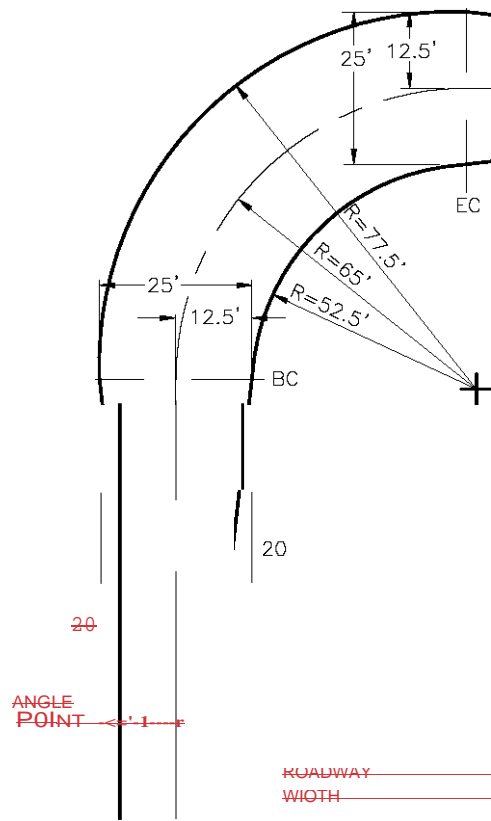

1. THIS DETAIL IS FOR A SU DESIGN VEHICLE ONLY. LARGER DESIGN VEHICLES WILL REQUIRE ADDITIONAL WIDENING.
2. THE ALLOWABLE INTERSECTION ANGLES ARE 75 TO 105 DEGREES.
3. IF PARKING IS PROVIDED ON ONE SIDE, THEN ONLY NEED TAPER AND WIDENING ON OPPOSITE SIDE OF ROAD. IF PARKING IS PROVIDED ON BOTH SIDES, THEN ADDITIONAL WIDENING IS NOT NECESSARY.
4. THIS DRAWING IS NOT TO SCALE.



KITSAP COUNTY  
DEPT. OF PUBLIC WORKS  
614 DIVISION STREET MS-26  
PORT ORCHARD, WA 98366  
TEL: (360) 337-5777 FAX: (360) 337-1867

"L" INTERSECTION

Date: 8/10/07

41

VERY LOW VOLUME LOCAL ROADS

FIGURE 4-5

PHASE DIAGRAM	
RING 1	RING 2

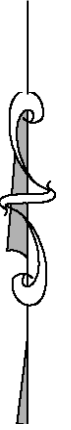
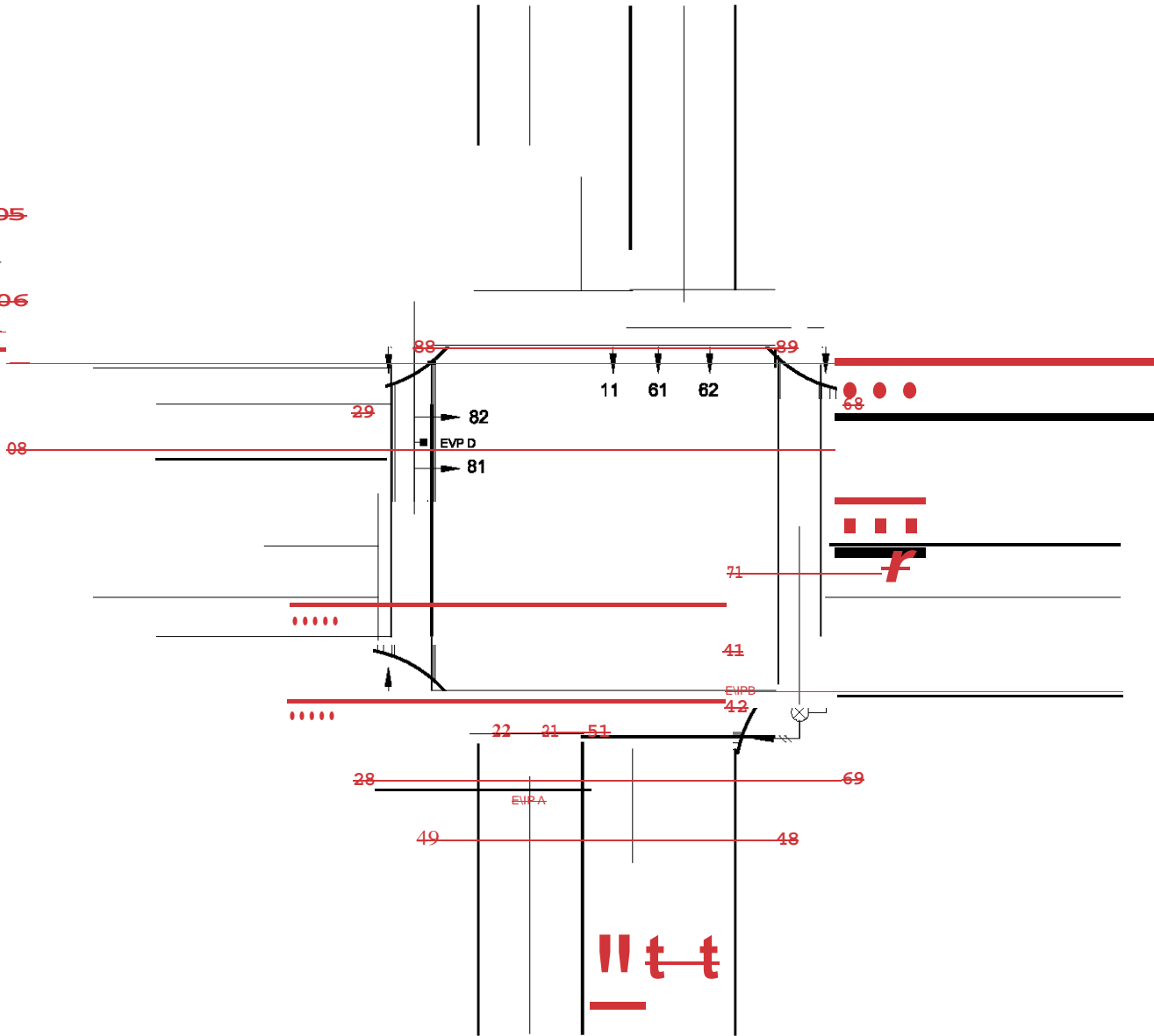

KITSAP COUNTY  
DEPT. OF PUBLIC WORKS  
614 DIVISION STREET MS-26  
PORT ORCHARD, WA 98366

TEL (360)337-5777 FAX (360) 337-5777

TRAFFIC SIGNAL PHASING

TYPICAL FOUR LEG INTERSECTION

Date: 8/10/07

FIGURE 5-1



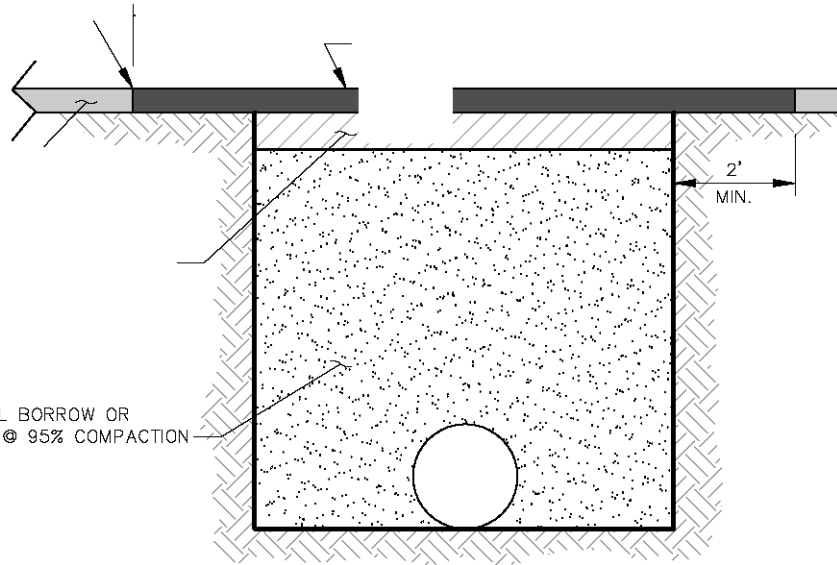

(MAX. 6" LIFTS) GRAVEL BORROW OR  
CONTROL DENSITY FILL @ 95% COMPACTION



SAW CUT (TACK FACE OF SAW  
CUT AND SEAL TOP OF JOINT  
WITH AR-4000W ASPHALT

WIDTH VARIES  
ASPHALT CONG. PATCH  
MATCH EX. (2" MIN.)



EXISTING ASPHALT  
CONCRETE SURFACE

ASPHALT TREATED BASE OR  
CRUSHED SURFACING TOP COURSE  
@ 95% COMPACTION (4" MIN.)

BACKFILL AND MECHANICALLY COMPACT

#### NOTES

1. ASPHALT CONCRETE MIX SHALL BE HOT MIX
2. ALL UTILITIES SHALL HAVE 36" MIN. COVER UNLESS OTHERWISE APPROVED BY THE COUNTY ENGINEER
3. ROADWAY PUSHES & BORES SHALL HAVE 48" MIN. COVER
4. IF ROAD CLOSURES OR DETOURS ARE ANTICIPATED, A TRAFFIC PLAN INCLUDING SPECIFIC DATES AND DURATIONS OF SUCH ACTIONS SHALL BE FILED WITH THE DEPARTMENT OF PUBLIC WORKS PER SECTION 8.2.2
5. THE APPLICANT IS RESPONSIBLE FOR ALL TEMPORARY AND PERMANENT PATCHING
6. NO OPEN TRENCHES LEFT OVERNIGHT

## STANDARD TRENCH / PAVEMENT RESTORATION

NOT TO SCALE

KITSAP COUNTY  
DEPT. OF PUBLIC WORKS  
614 DIVISION STREET MS-26  
PORT ORCHARD, WA 98366  
TEL: (360) 337-5777 FAX: (360) 337-1867

---

**STANDARD TRENCH AND PAVEMENT RESTORATION**

Date: **8/10/07**

**41**  
**FIGURE 7-1**